

Ar Saoghal
Ire 2

Micheal Tapaaidh



Ainm: _____

Ainm: _____

Micheal Tapaidh

Cuir crìoch air an dealbh.

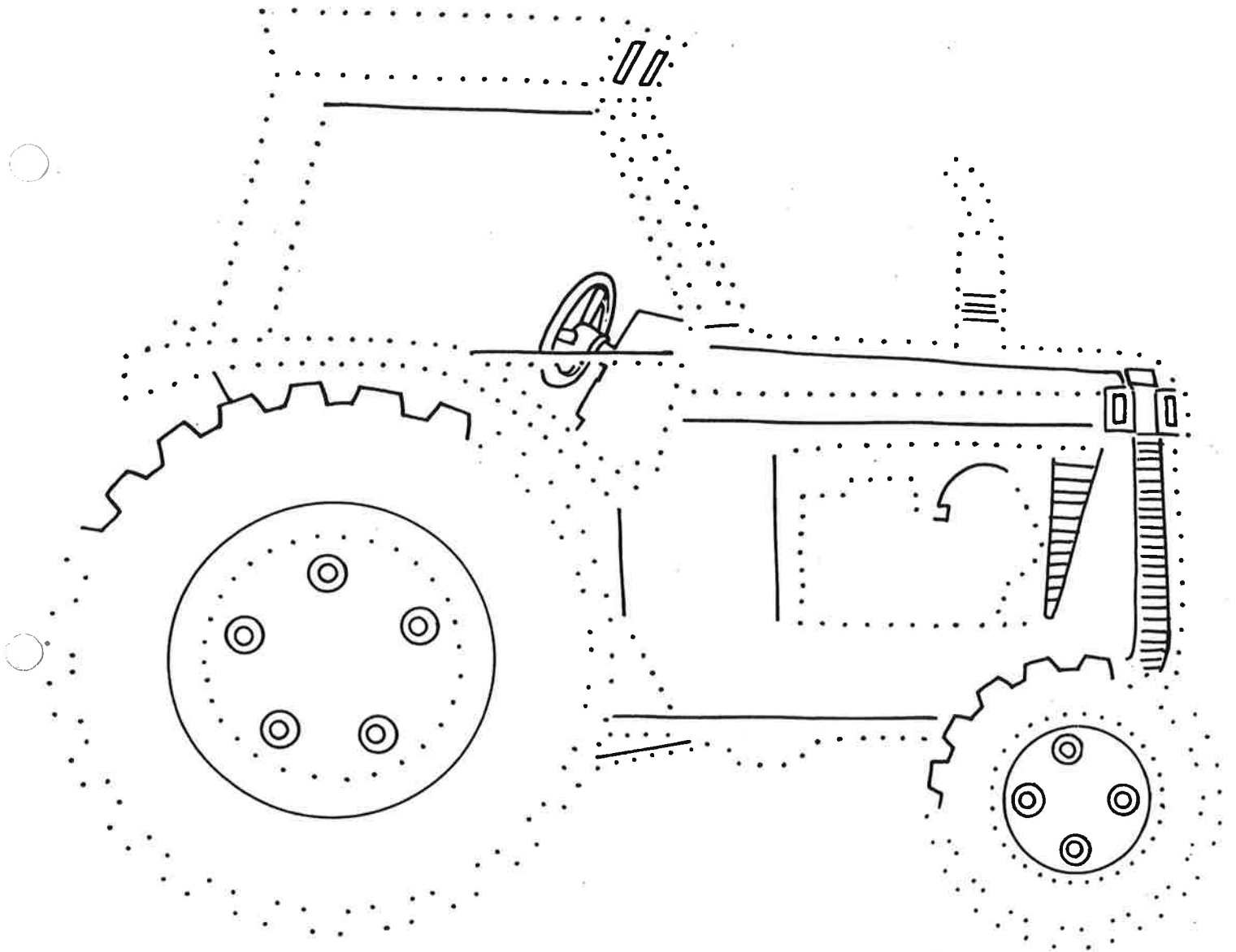

Sgil: A' dèanamh chumaidhean sgrìobhaidh.

Ainm: _____

Micheal Tapaich

Tagh trì dathan agus dèan litir bogha-fhrois.
Maids na dealbhan ceart ri p.

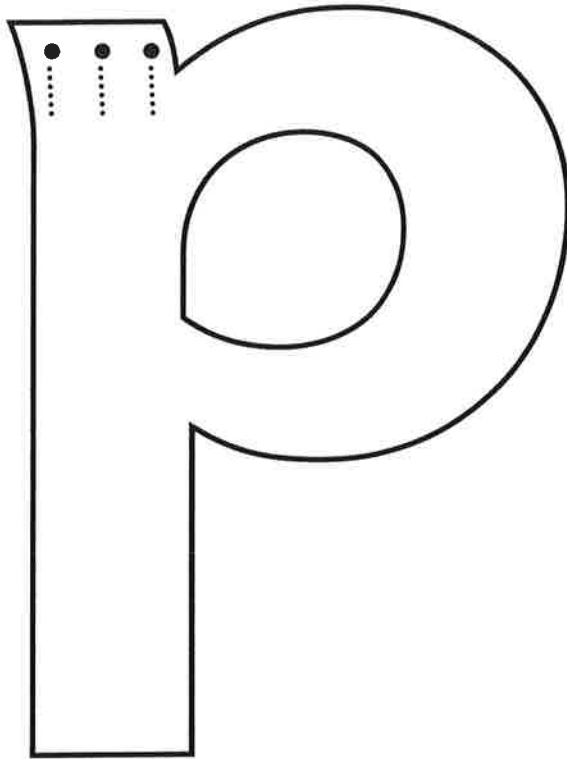
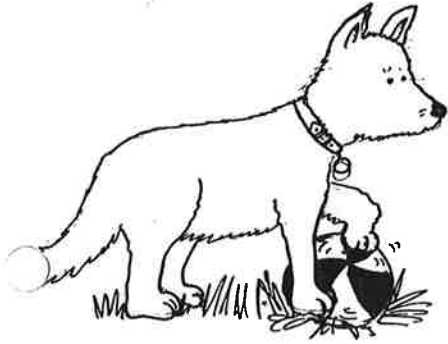

Dèan an litir p gu h-ìosal a-nis.

Sgil: A' cumadh litrichean le peansailean dathte.
Ag aithneachadh fuaimean aig toiseach fhacal.

Ainm: _____

Micheal Tapaadh

Maid na dealbhan ri na litrichean.

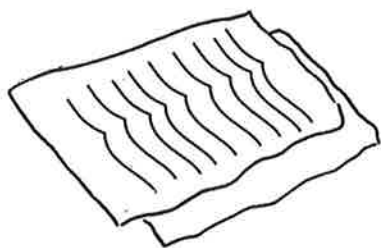

a



c



b

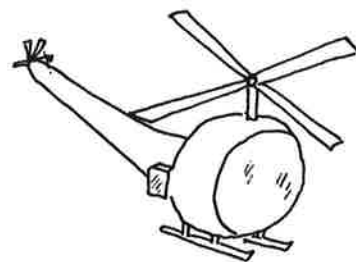

p



s



t



f

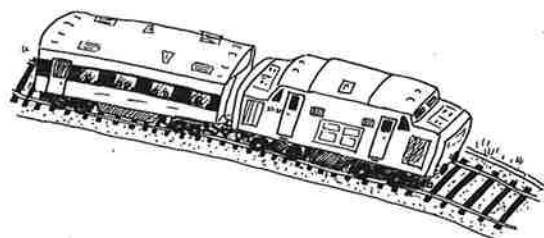

h

Sgil: A' maidseadh na litreach ri dealbh ceart.

Ainm: _____

Mìcheal Tapaìdh

Dèan dealbhan.

Cuir an dath ceart air gach dealbh.

Dèan tractar uaine.

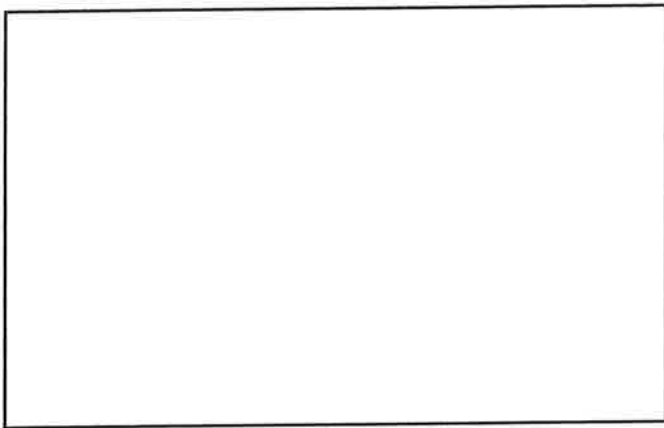

Tha an _____ uaine.

Dèan bus dearg.

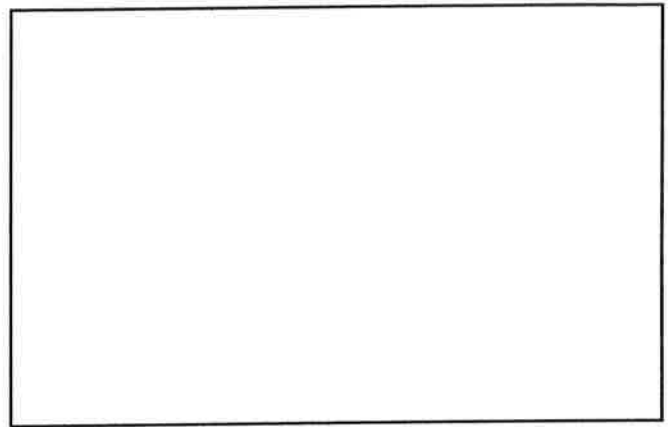

Tha am _____ dearg.

Dèan cù ruadh.

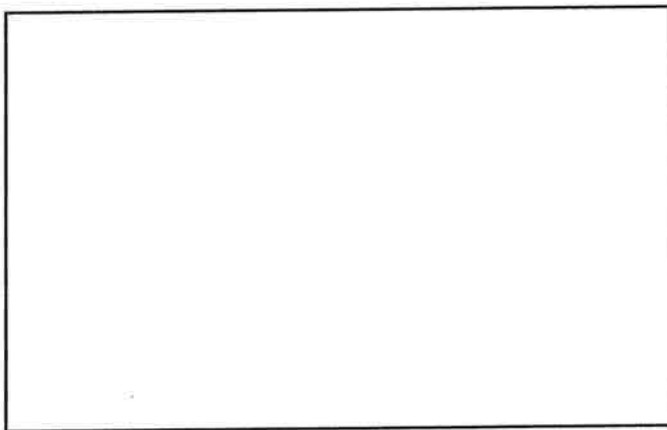

Tha an _____ ruadh.

Dèan càr gorm.

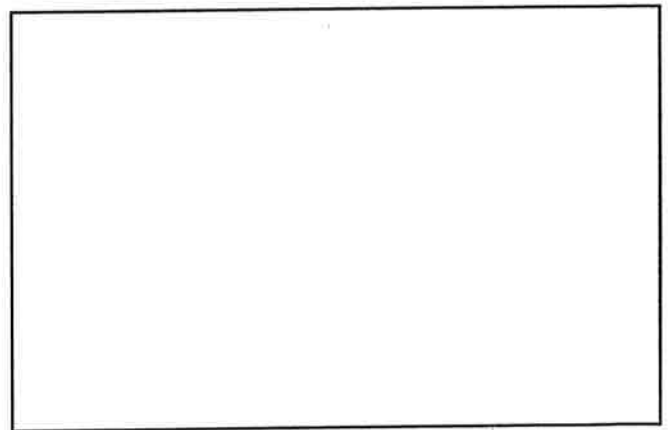

Tha an _____ gorm.

Sgil: Ag aithneachadh na litreach ceart ann am facail is aithne dhaibh.
Ag aithneachadh dhathan.

Ainm: _____

Mìcheal Tapaidh

Cuir cearcall air na facail a tha an aon seòrsa.

seall càr seall thuirte seo seall

mise thuirte bus mise an mise

faod thuirte faod an seall faod

tractar càr tractar am seo tractar

Sgrìobh an seantans seo.

Seall an tractar.

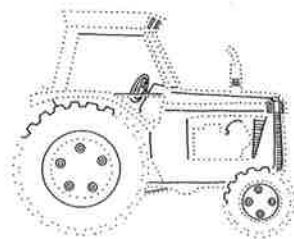

Sgil: Ag aithneachadh agus a' taghadh fhacal a tha an aon seòrsa.

Ainm: _____

Micheal Tapaich

Sgrìobh air muin nam facal soilleir agus nuairsin sgrìobh na facail air na loidhnichean.

faod

faod

mise

mise

mise

tractar

tractar

Ainm: _____

Mìcheal Tapaìdh

Cò thuirt e?

Mamaidh

Eilidh

Mìcheal

“O seall, càr-poileis,” thuirt



“Am faod mise fhaicinn?” thuirt



“O seall, tractar,” thuirt



Sgil: A' cuimhneachadh air an stòiridh.

Ainm: _____

Mìcheal Tapaìdh

Cuir na facail cheart anns na beàrnan sna seantansan agus dèan dealbhan.

anns

air

aig

Tha ad _____ a' chù.

Tha am poileas _____ a' char.

Tha tractar beag _____ Mìcheal.

Sgil: A' taghadh roimhear freagarrach airson sheantansan.

Ainm: _____

Micheal Tapaídh

Maids na facail ri na dealbhan.
Nuairsin cuir dath air na dealbhan.

càr



tractar

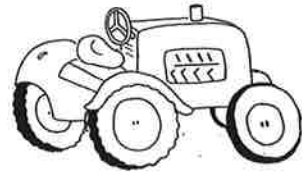

bus



bhan

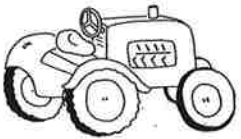
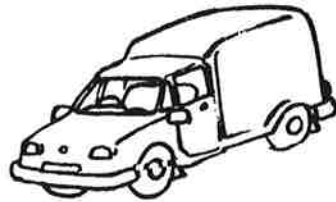

Sgil: A' maidseadh fhacal ri na dealbhan ceart.

Ainm: _____

Micheal Tapaidh

Cuir cearcall air a' chiad fhuaim anns gach facal.

s u b d a 

r p t s c 

o e d a t 

b c g p h 

m n h r s 

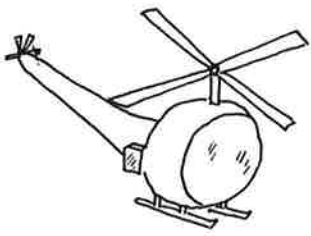
p t r h e 

Sgil: Ag aithneachadh fuaim aig toiseach facail.

Ainm: _____

Mìcheal Tapaidh

Cuir na facail dhan òrdugh cheart
airson seantans a dhèanamh.

càr O seall poileis.

mise faod Am fhaicinn?

thuirte bus seall O am Mamaidh.

Dèan dealbh de Mhìcheal.

Sgil: A' cur fhacal dhan òrdugh cheart airson seantans a dhèanamh.

Ainm: _____

Mìcheal Tapaidh

Tha na facail air falbh às a chèile.
Lorg na pìosan ceart agus càirich na facail.

Mìch	tract	mam	poil
eas	ar	eal	aidh

Sgrìobh na facail an seo.

poil _____

tract _____

mam _____

Mìch _____

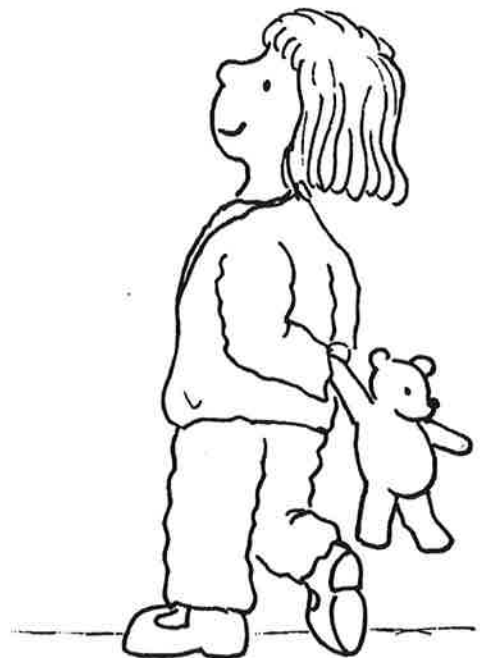

Sgil: A' mothachadh do lidean ann am facail san stòiridh.