

1) Sgrìobh am meud a tha:

1 deich notaichean a bharrachd air

- (a) £370      (b) £807      (c) £690      (d) £96

2 deich notaichean nas lugha na

- (a) £750      (b) £413      (c) £108      (d) £900

3 ceud not a bharrachd air

- (a) £259      (b) £701      (c) £640      (d) £900

4 ceud not nas lugha na

- (a) £809      (b) £445      (c) £780      (d) £162

5 coagad not a bharrachd air

- (a) £600      (b) £150      (c) £450      (d) £950

6 coagad not nas lugha na

- (a) £850      (b) £400      (c) £700      (d) £150.



Tom

Pat

Kim

Roy

Ben

Anna



7 Dè na tha aig gach duine de dh'airgead an dèidh

- (a) Pat £50 a thoirt do Kim      (b) Anna £100 a thoirt do Roy  
(c) Tom £10 a thoirt do Bhen?

8 Sgrìobh an t-iomad de:

- (a) 10 eadar 370 agus 390  
(b) 100 eadar 800 agus 600  
(c) 50 eadar 400 agus 500.





1 Sgrìobh an àireamh a tha:

(a) an dèidh 3682

(b) ro 5001

(c) 1 a bharrachd air 3999

(d) 1 nas lugha na 4080

(e) 2 a bharrachd air 6300

(f) 2 nas lugha na 2000.

2 Dèan liosta de na h-àireamhan a tha eadar:

(a) 3417 agus 3421

(b) 6403 agus 6398

(c) 8996 agus 9003

(d) 1004 agus 995.

3 Sgrìobh an àireamh a tha:

• 10 a bharrachd air (a) 1560 (b) 7000 (c) 6590 (d) 4993

• 10 nas lugha na (e) 5270 (f) 2600 (g) 3031 (h) 10000.

4 Lorg faid gach drochaid.

(a)



(b)



5 Sgrìobh an t-iomad de 10 a tha eadar:

(a) 2170 agus 2190 (b) 10000 agus 9980 (c) 6990 agus 7010.

6 Sgrìobh iomad de 10 a tha eadar:

(a) 7000 agus 7100 (b) 9050 agus 9000 (c) 3050 agus 2950.





1 Sgrìobh sgòr gach geama coimpiutair.

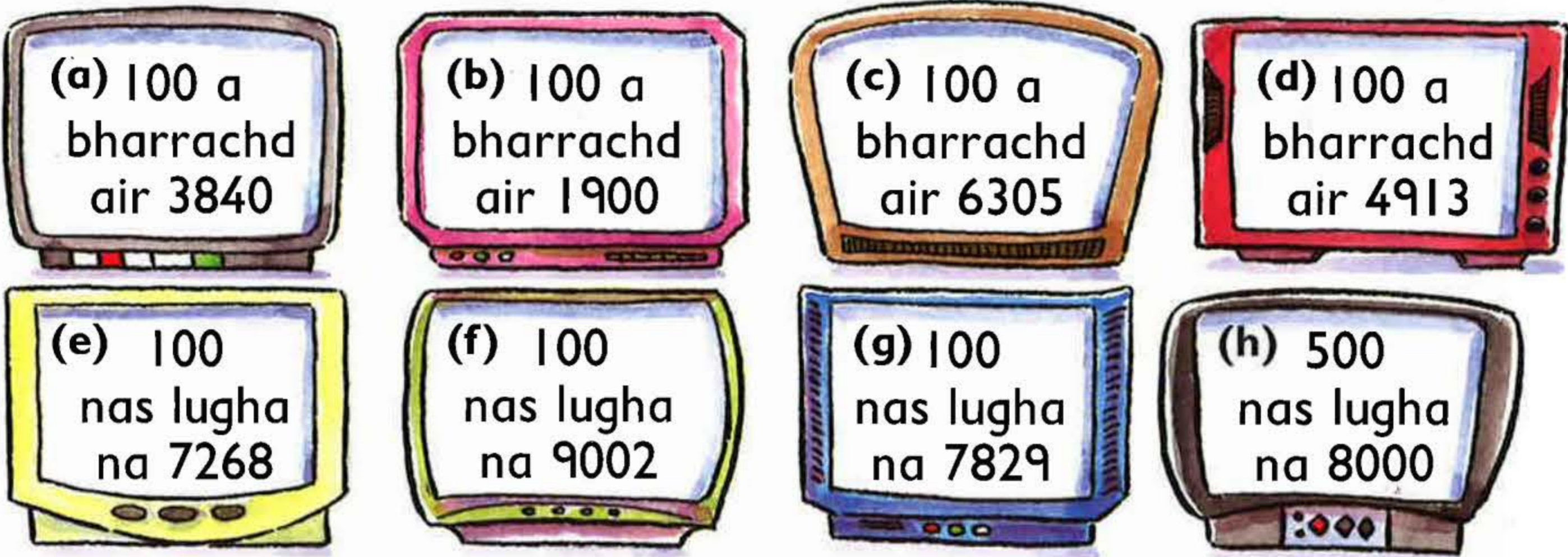

2 Sgrìobh an àireamh a tha:

- 1000 a bharrachd air (a) 2100 (b) 4630 (c) 8307 (d) 424
- 1000 nas lugha na (e) 5700 (f) 4409 (g) 9000 (h) 1520.

3 Cia mheud puing a tha aig gach cluicheadair a-nise?

Cluicheadair	Puingean
Rob	947
Amy	10000
Li	7888
Sula	10000
Asif	6000

Sgòr 100
A' call 1000
Sgòr 1000
A' call 100
Sgòr 500

4 Sgrìobh iomad de 100 eadar

- (a) 9300 agus 9500 (b) 7000 agus 6000 (c) 4100 agus 3900.

5 Sgrìobh iomad de 1000 eadar

- (a) 4000 agus 2000 (b) 10000 agus 6000 (c) 3000 agus 0.



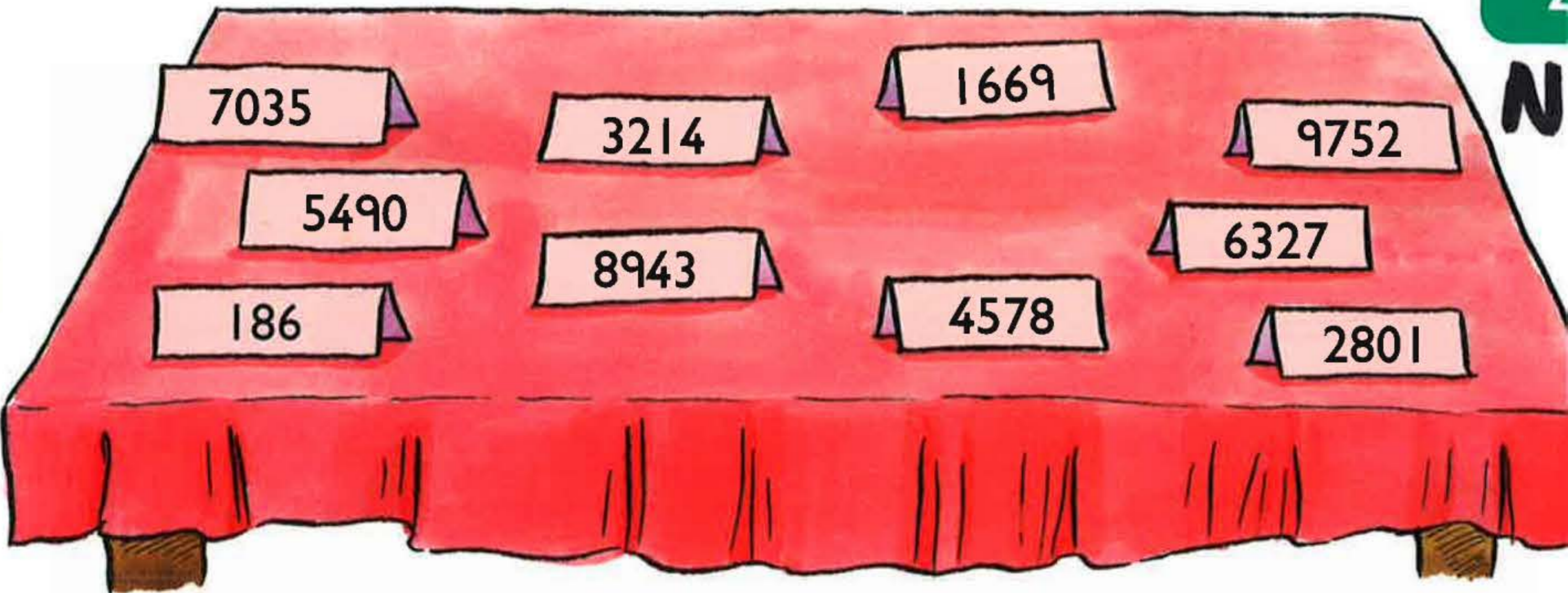

1 Sgrìobh an àireamh anns a bheil:

- |                |                |              |
|----------------|----------------|--------------|
| (a) 5 aonadan  | (b) 7 deichean | (c) 9 ceudan |
| (d) 6 mìltean  | (e) 0 aonadan  | (f) 2 cheud  |
| (g) 0 deichean | (h) 1 mhìle    | (i) 1 cheud  |



2 Sgrìobh àireamh anns a bheil:

- (a) figear 3 sna mìltean **agus** figear 1 sna ceudan
- (b) figear 5 sna ceudan **agus** figear 7 sna h-aonadan
- (c) figear 3 sna mìltean **agus** figear 1 sna deichean
- (d) figear 0 sna ceudan **agus** sna deichean.



3



Dè an àireamh a tha agam?

- 'S e am figear 8 a tha anns na mìltean, agus tha seo dhà nas motha na am figear anns na ceudan.
- Tha figear nan aonadan aon nas lugha na figear nan deichean.
- Tha figear nan ceudan dhà uiread ri figear nan aonadan.



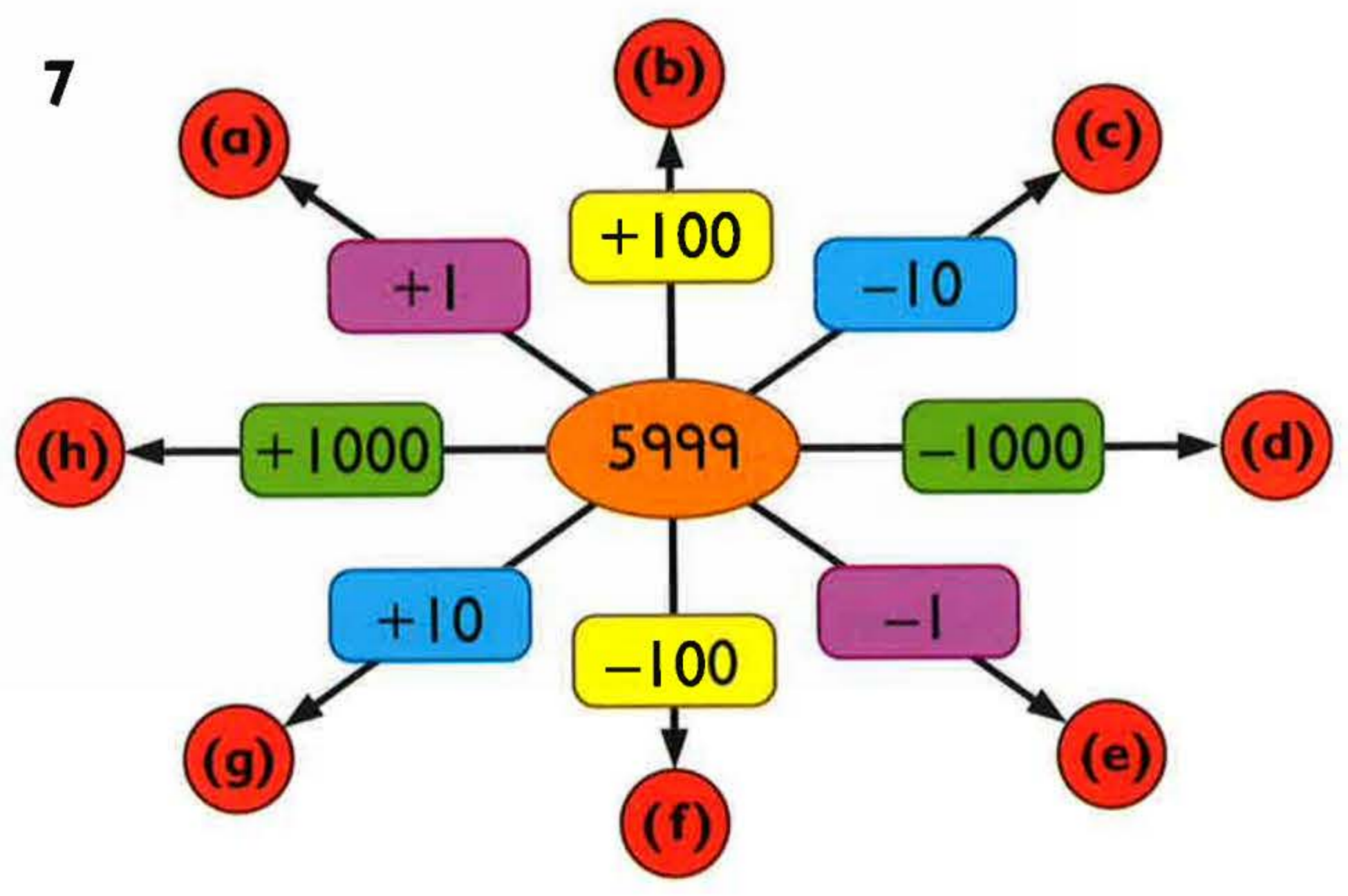
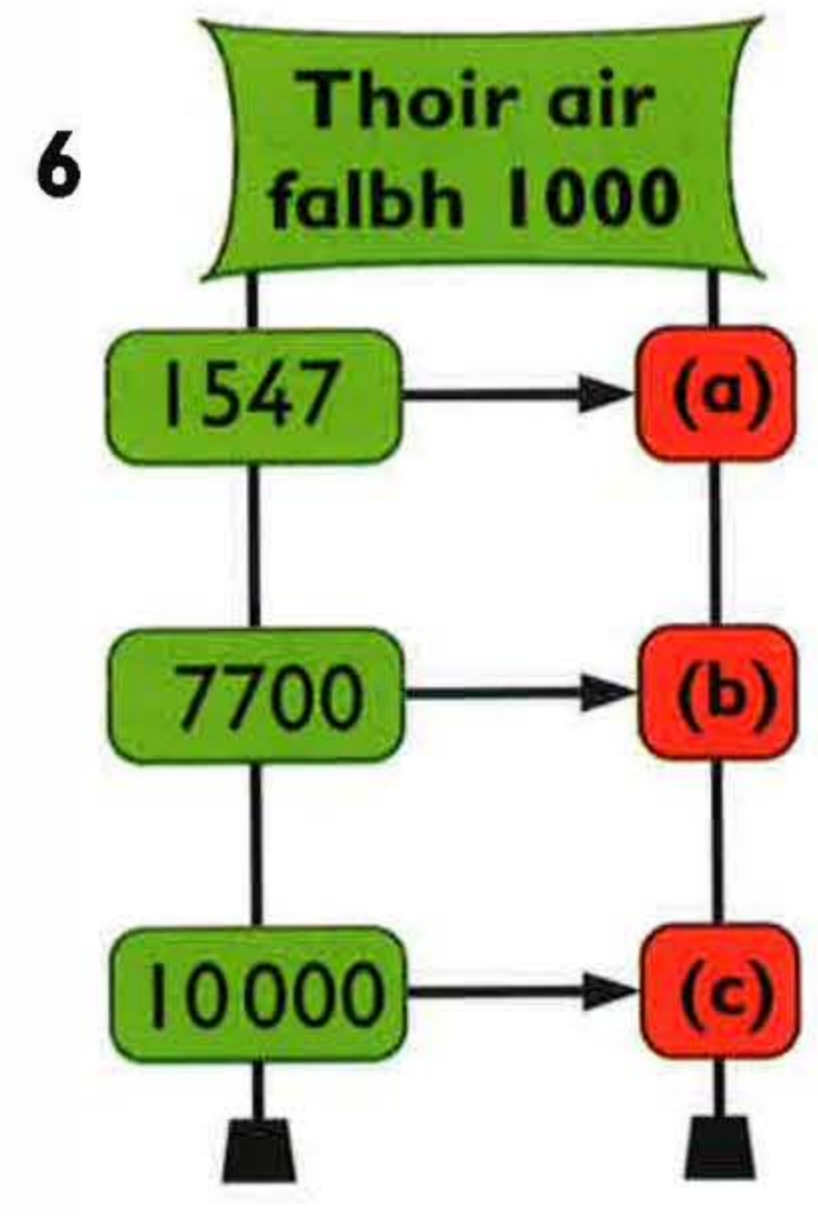
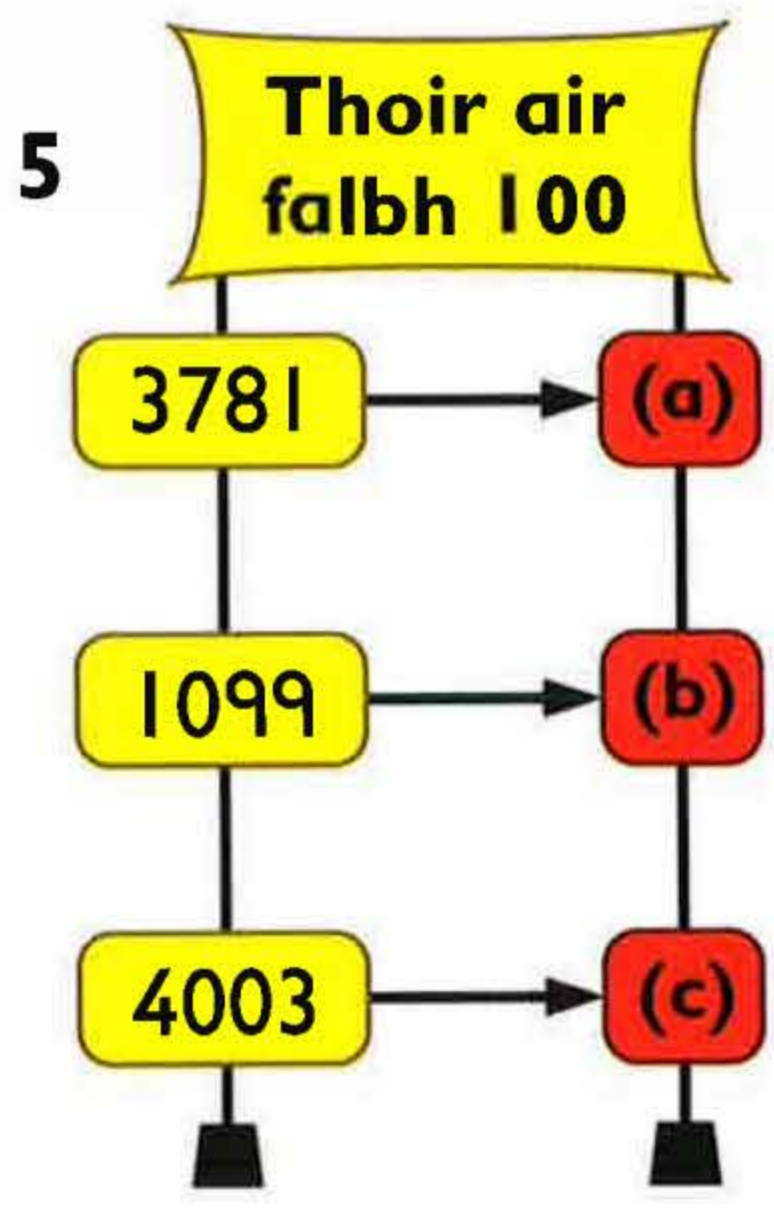
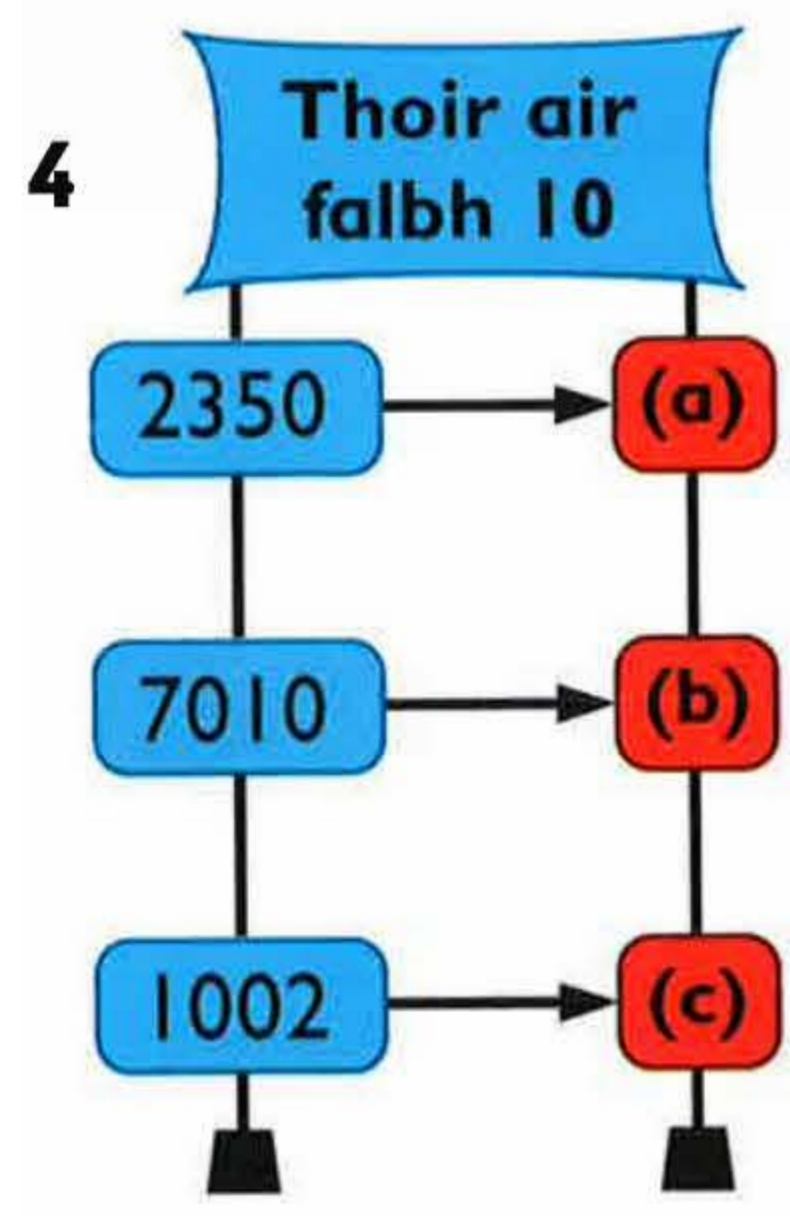
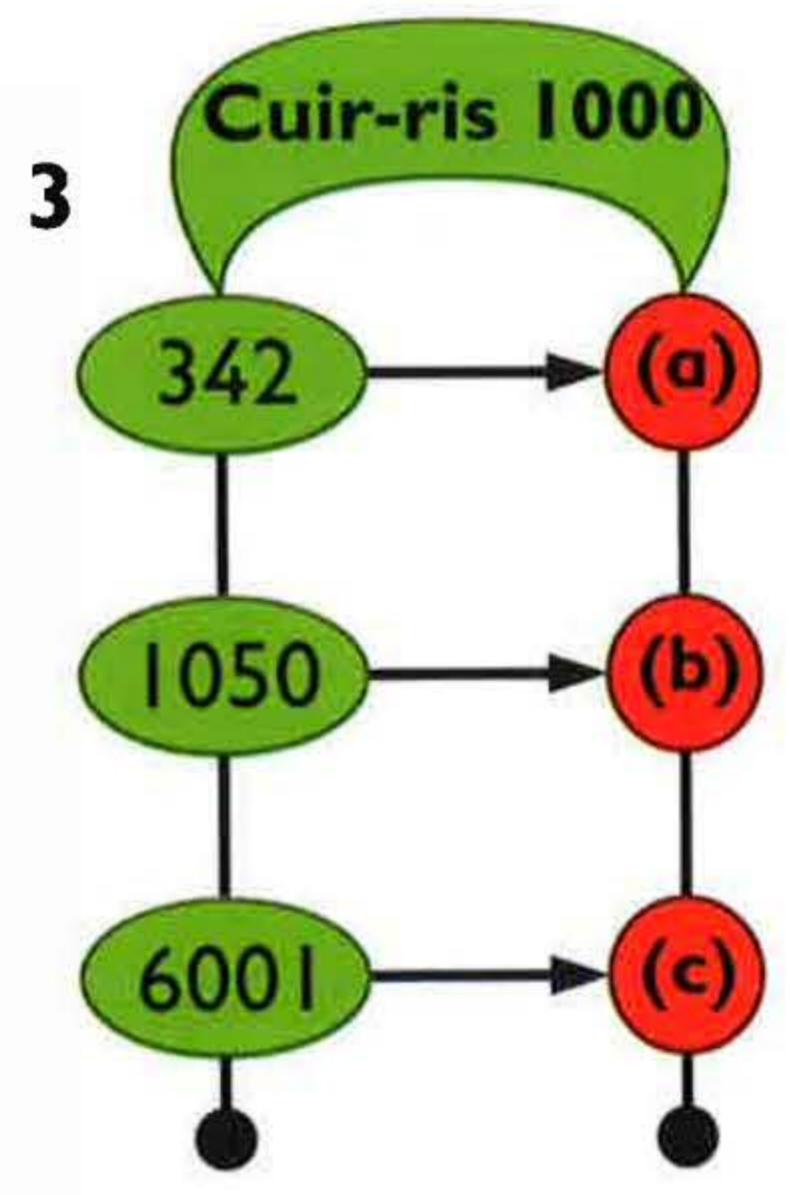
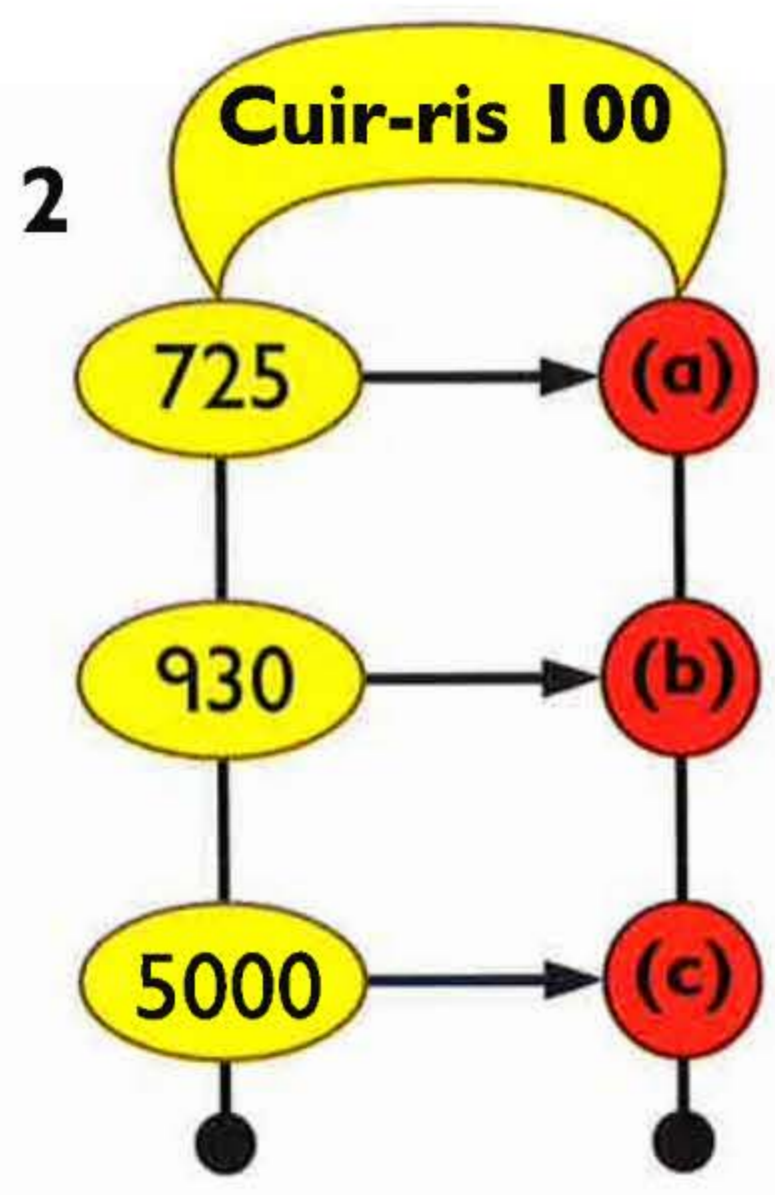
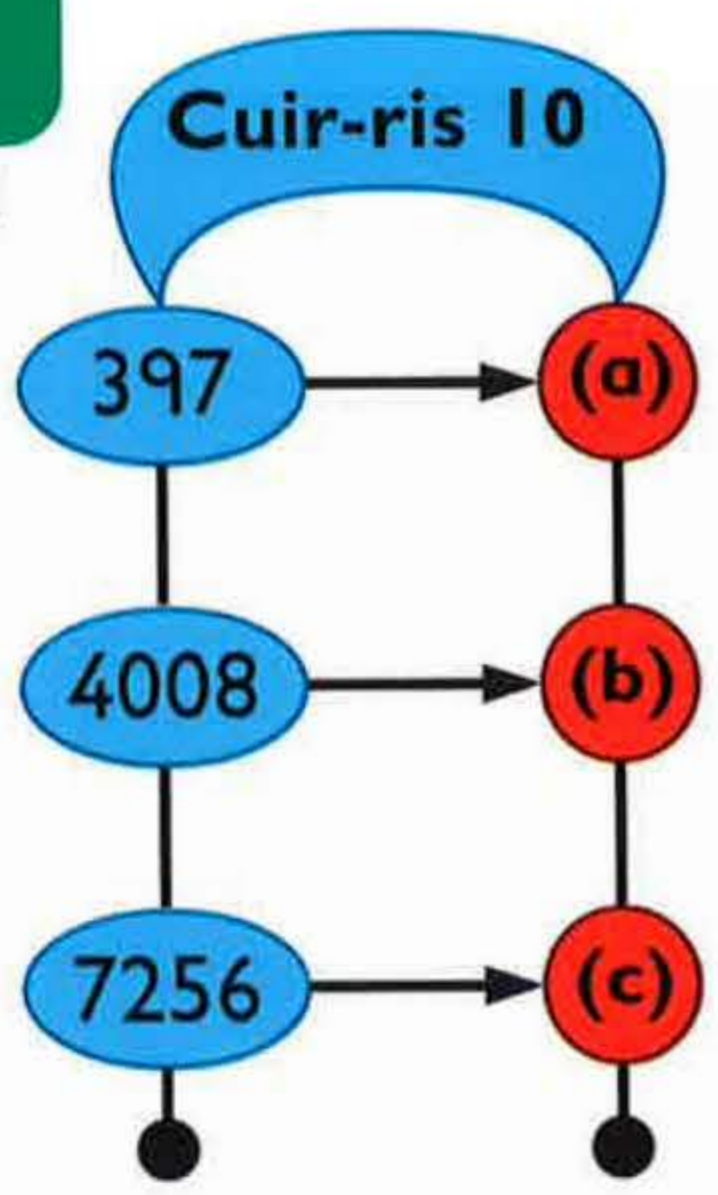



1 Sgrìobh an àireamh as **motha**.



2 Sgrìobh an àireamh as **lugh**a.



3 Sgrìobh **ceart** no **ceàrr** airson gach eisimpleir.

- (a)  $6087 > 5987$  (b)  $3060 < 3606$  (c)  $2717 < 2171$   
(d)  $10000 > 9100$  (e)  $2002 > 2220$  (f)  $9600 < 9660$

4 Sgrìobh am (a) meud as **motha** (b) meud as **lugh**a.



5 Dè an dath a tha air a' chàr (a) as saoire (b) as daoire?



6 Sgrìobh iad seo ann an òrdugh. Tòisich leis an fhear

(a) as **truime**



(b) as **aotruime**





Sgrìobh iad seo ann am **figearan**.



(a) Deich mìle

(b) Dà mhìle agus còig cheud

(c) Còig mìle dà cheud agus caogad

(d) Naoi mìle agus trichead 's a dhà

(e) Trì mìle ceithir cheud agus seachd-deug

(f) Seachd mìle agus a h-aon



Sgrìobh iad seo ann am **facail**.

(a) 4000

(b) 1007

(c) 8300

(d) 6623

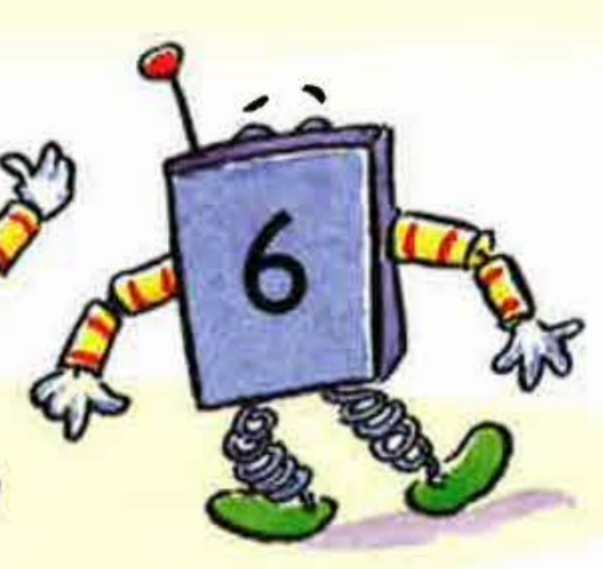
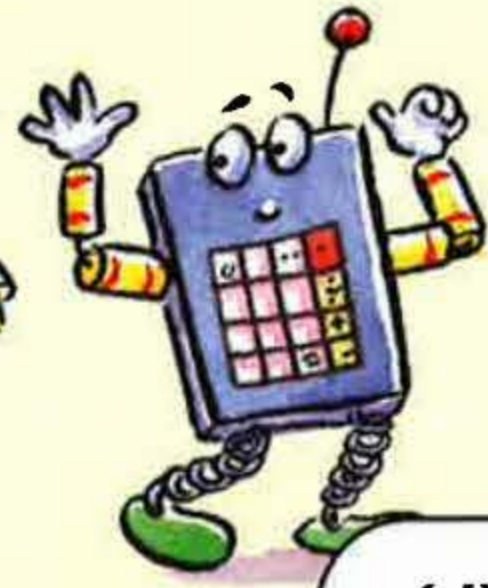
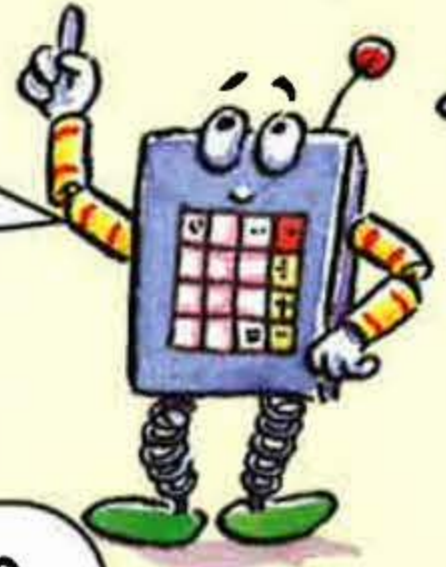

3 Sgrìobh ann **am facail**, a' cleachdadh nan **ceithir figearan**

(a) an àireamh as motha a gheibh thu

(b) an àireamh as lugha a gheibh thu.



Leugh leabhar  
gach latha

# Seachdain leabhraichean



Tha mi air a'  
chaogadamh duilleig.



...seachdamh duilleag

...ceudamh duilleag



...ochdamh duilleag



...seasgadamh duilleag



...naochdamh duilleag

1 Cò a tha a' leughadh an:

- (a) 80mh duilleag      (b) 90mh duilleag      (c) 70mh duilleag
- (d) 60mh duilleag      (e) 50mh duilleag      (f) 100mh duilleag?

2 Cò a tha air leughadh (a) as motha (b) as lugha de dhuilleagan?

- 3 Cò a tha air leughadh
- (a) 10 duilleagan a bharrachd air Sam
  - (b) 20 duilleag a bharrachd air Mia
  - (c) dhà uiread air na tha Sue air leughadh.



4 Sgrìobh iad seo ann am **facail**.

- (a) 40mh      (b) 10mh      (c) 100mh      (d) 30mh      (e) 20mh



Dèan tuairmse.

1 Cia mheud **ceudameatair** a tha gach seilcheag air siubhal?

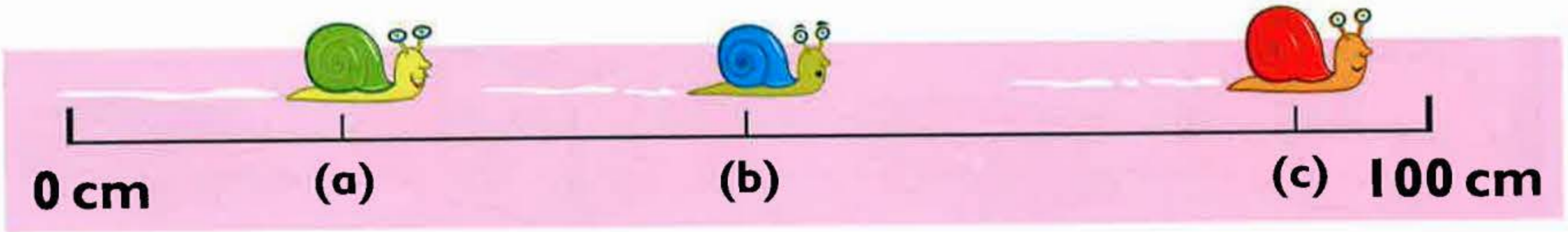

2 Cia mheud **meatair** a tha gach ruitheadair air ruith?

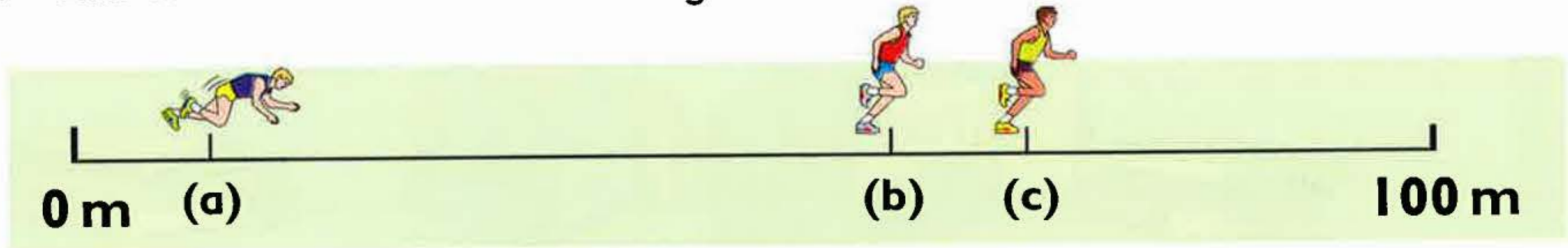

3 Cia mheud **cilemeatair** a tha gach càr air siubhal?

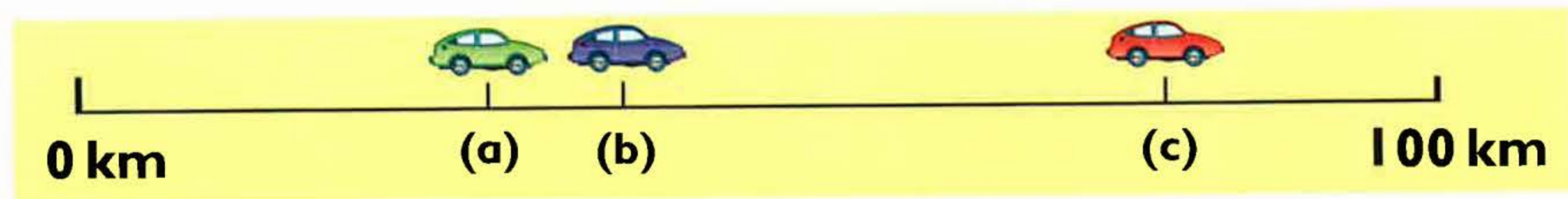

4 Tha an àireamh air gach mullach a' sealltainn na ghabhas gach sileagan nuair tha iad làn.  
Dèan tuairmse air na tha anns gach sileagan de shiùcaran an-dràsta.

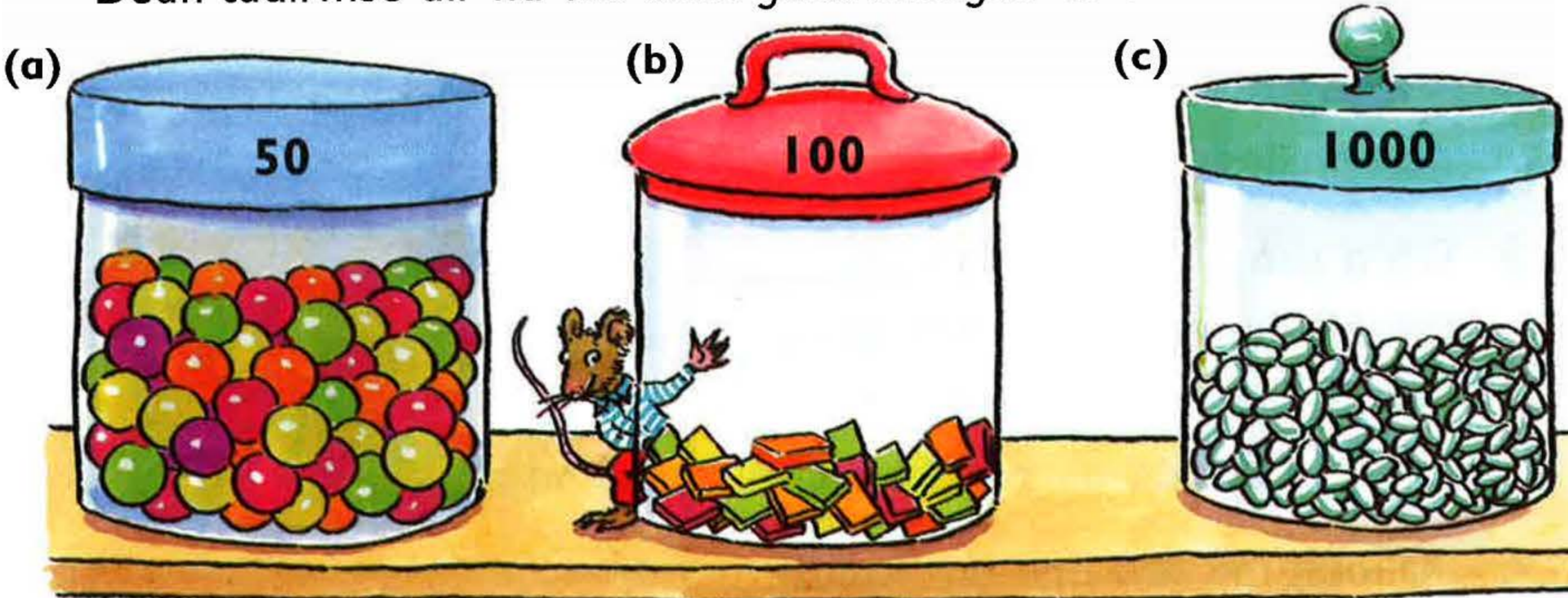



1 Cia mhead duine, chun a' **cheud as fhaisce**, a tha a' fuireach anns gach fear de na bailtean seo?

(a)

(b)

(c)

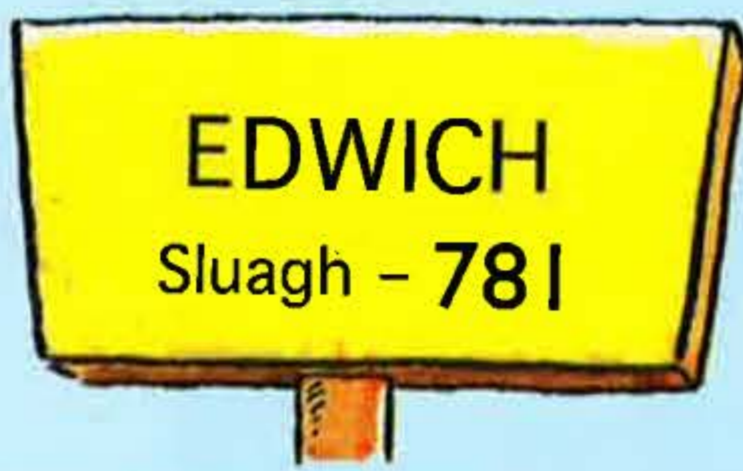

2 Sgrìobh iad seo chun a' **cheud as fhaisce**.

(a) 449

(b) 98

(c) 707

(d) 991

(e) 350

3 Sgrìobh na h-àireamhan a tha:

(a) nas fhaisce air 70 na air 80

(b) nas fhaisce air 730 na air 720.



4 Sgrìobh àirde gach beinn chun na **deich meatairean as fhaisce**.

(a) Beinn Mhòr

(b) Beinn Ruadh

(c) Beinn Umha

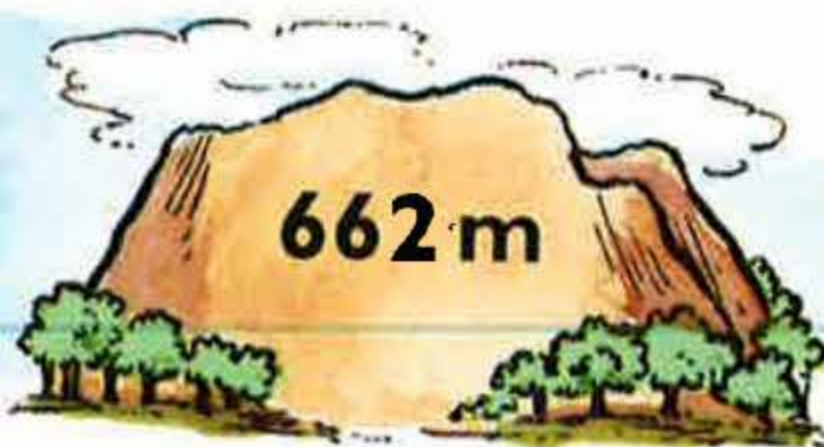
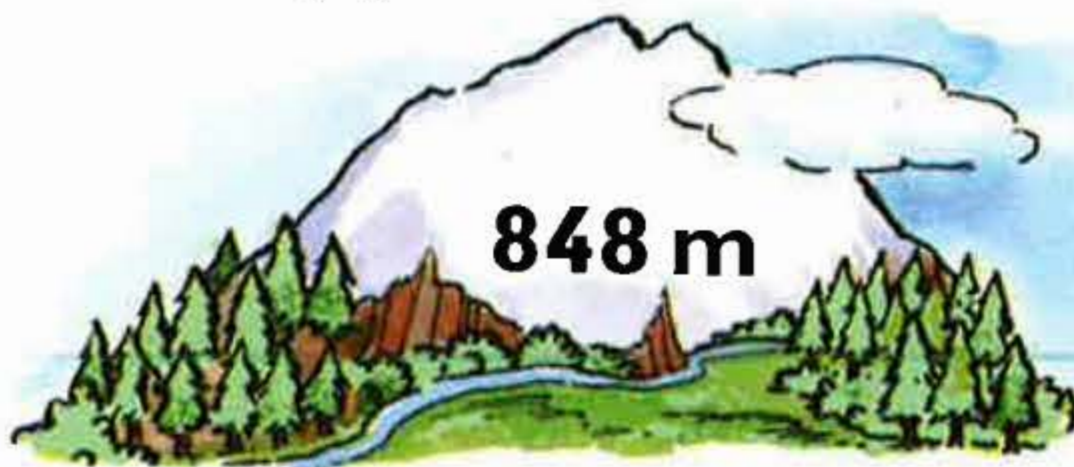

5 Sgrìobh iad seo chun an deich **as fhaisce**.

(a) 119

(b) 751

(c) 604

(d) 555

(e) 997

6 Sgrìobh gach astar à Farnham

(a) chun a' cheud mìle as fhaisce

(b) chun a' cheud deich mìle as fhaisce

Astaran à Farnham	
Edwich	- 86 mìle
Aberton	- 264 mìle
Oakham	- 225 mìle



Dùblaich gach àireamh

(a) 12	(b) 24	(c) 33	(d) 42	(e) 13
(f) 41	(g) 32	(h) 14	(i) 22	(j) 34
(k) 21	(l) 44	(m) 23	(n) 31	(o) 11

2 Sgrìobh an àireamh a tha air cairt dheirg leis an dùblachadh aice air cairt ghorm.

27	48	28	47	Dùblaich	96	78	54	58
16	39	29			32	94	56	

3	(a) $43 + 43$	(b) $43 + 44$	(c) $42 + 43$
	(d) $36 + 36$	(e) $36 + 34$	(f) $38 + 36$

4	(a) $17 + 19$	(b) $37 + 35$	(c) $47 + 48$	(d) $26 + 27$
	(e) $38 + 39$	(f) $46 + 45$	(g) $27 + 25$	(h) $16 + 18$
	(i) $22 + 23$	(j) $35 + 34$	(k) $13 + 15$	(l) $44 + 46$



1 Cia mheud pìos sgudail a chruinnich gach leanabh gu lèir?

NA GLANADAIREAN		
Ainm	Seachdain 1	Seachdain 2
Fifi	45	19
Samir	58	26
Eve	27	44
Ali	34	36
Josh	43	38



2

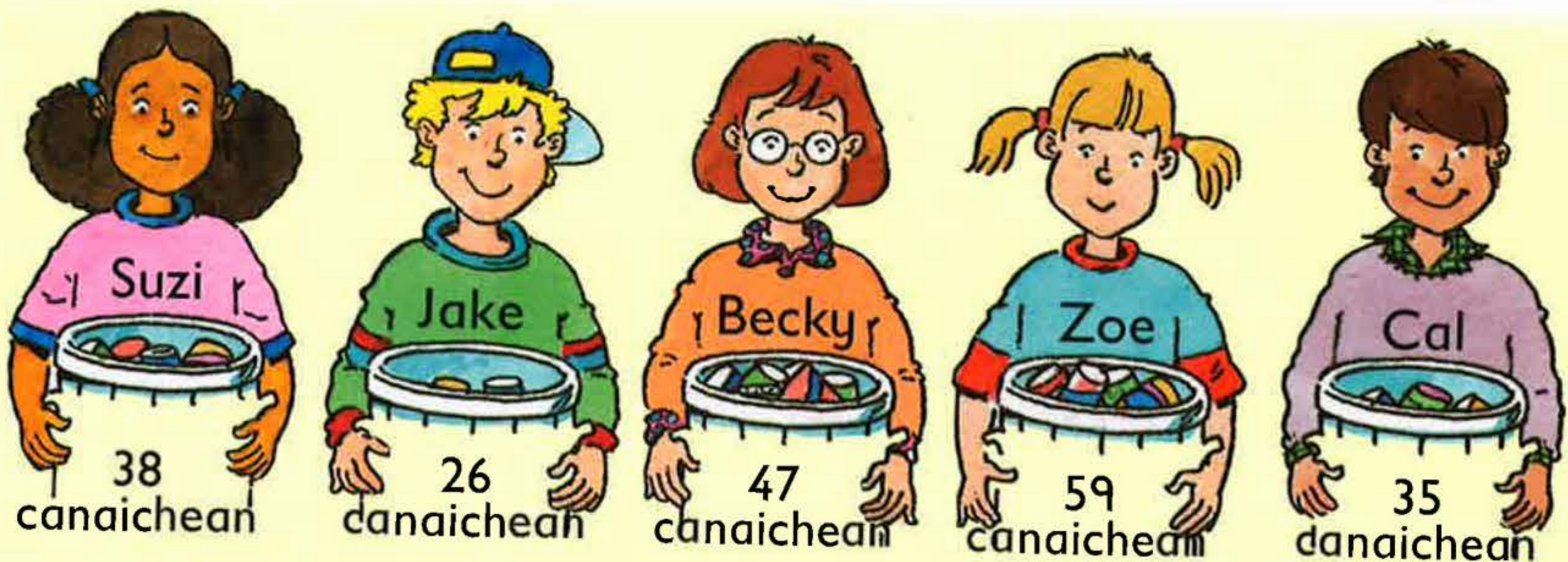

Lorg an àireamh chanaichean a chruinnich:

- (a) Suzi agus Becky (b) Zoe agus Jake (c) Jake agus Cal  
 (d) Becky agus Cal (e) Jake agus Becky (f) Suzi agus Zoe.

3 Cia mheud cana a dh'fheumas gach leanabh cruinneachadh gus an targaid a ruighinn?



- 4 (a)  $58 + \blacksquare = 73$  (b)  $27 + \blacksquare = 81$  (c)  $38 + \blacksquare = 96$   
 (d)  $\blacksquare + 17 = 94$  (e)  $\blacksquare + 46 = 93$  (f)  $\blacksquare + 24 = 92$



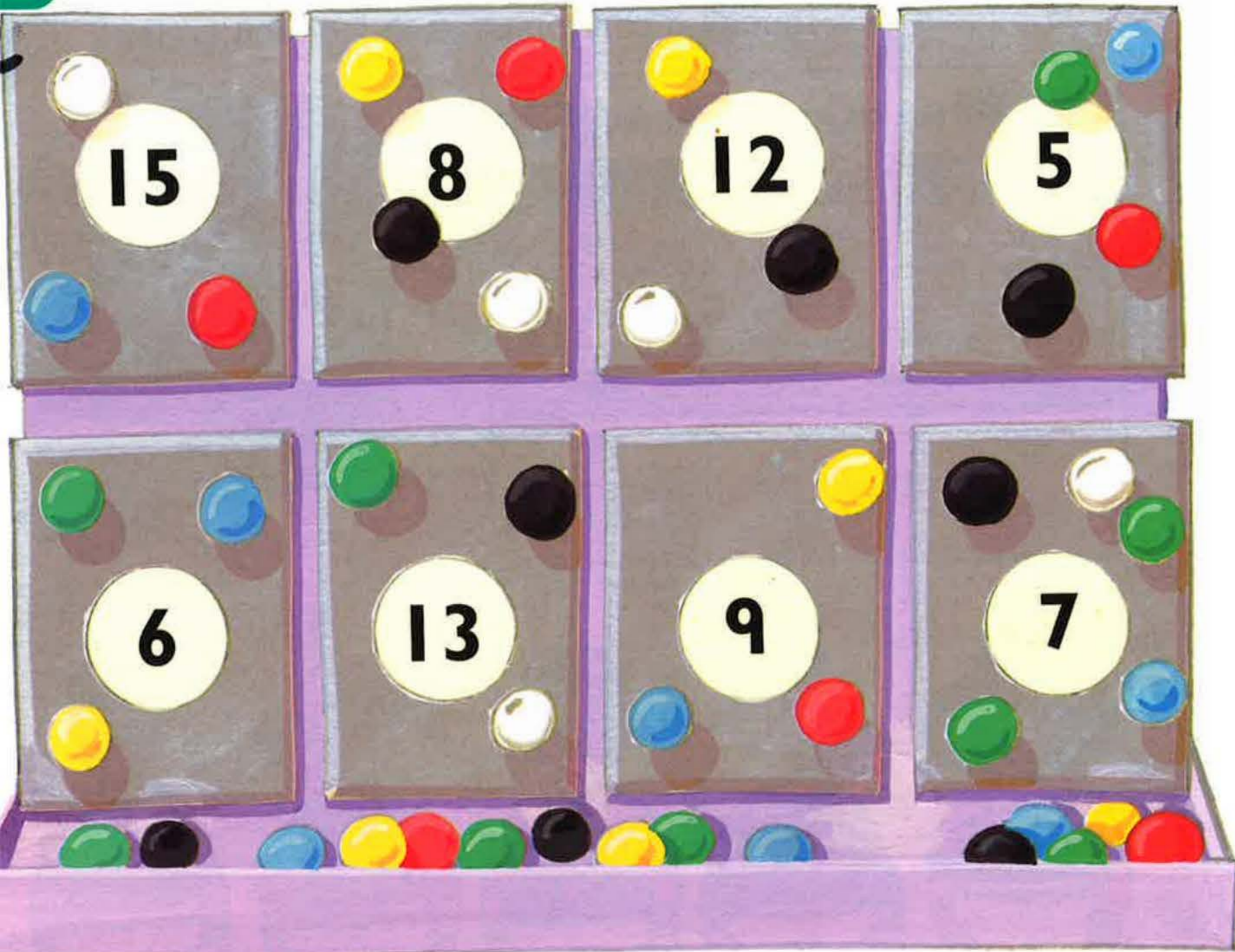

- 1 Cia mheud puing a chaidh a sgòradh leis a':
  - chluicheadair dhearg
  - chluicheadair bhuidhe
  - chluicheadair dhubh
  - chluicheadair uaine
  - chluicheadair ghorm
  - chluicheadair gheal?
- 2 Thilg gach cluicheadair bàlla eile, agus seo na suimean ùra aca.
  - dearg ➡ 50 puing
  - buidhe ➡ 41 puing
  - dubh ➡ 54 puingean
  - uaine ➡ 53 puingean
  - gorm ➡ 49 puingean
  - geal ➡ 68 puingean
 Dè an àireamh a bhuail gach cluicheadair?
- 3 Sgrìobh diofar dhòighean anns am faigheadh tu 30 le trì tilgean.



# 1 Dè na tha aig gach duine de dh'airgead?



Mae

Tha £40 a bharrachd air na tha aig Zac agam.



Molly

Tha £19 agam.

Tha dhà uiread agam 's na tha aig Molly.



Zac



Tara

Tha £22 a bharrachd air Mae agam



Jack

Tha £26 agam a bharrachd air na tha aig Molly agus Zac còmhla.

# 2 Lorg àireamh gach leanabh.



Wasim

Suim 12, 14, 8, 15 agus 10



Sue

Suim 16 agus 17, air a chur ri 48.



Ann

Nuair chuireas mi 48 ris an àireamh agam, gheibh mi 75.



Des

28 air a chur ri suim 13 agus 15 air a dùblachadh.



48	55	26	33
27	45	38	46



# 3 Sgrìobh dà àireamh:

(a) aig a bheil suim eadar 60 agus 70

(b) a tha cothromach, agus aig a bheil suim eadar 80 agus 90.

(c) a tha corra, agus aig a bheil suim nas motha na 90





I Lorg na chosgas:

(a) agus (b) agus

(c) agus (d) agus

- 2 (a)  $84 + 50$  (b)  $65 + 80$  (c)  $90 + 74$   
 (d)  $20 + 96$  (e)  $90 + 16$  (f)  $83 + 40$   
 (g)  $98 + 30$  (h)  $50 + 72$  (i)  $80 + 71$



Cia mheud cairt a tha ann gu lèir?

- 4 (a) Cò aig a tha barrachd bhailiùnaichean?  
 (b) Cia mheud a bharrachd?

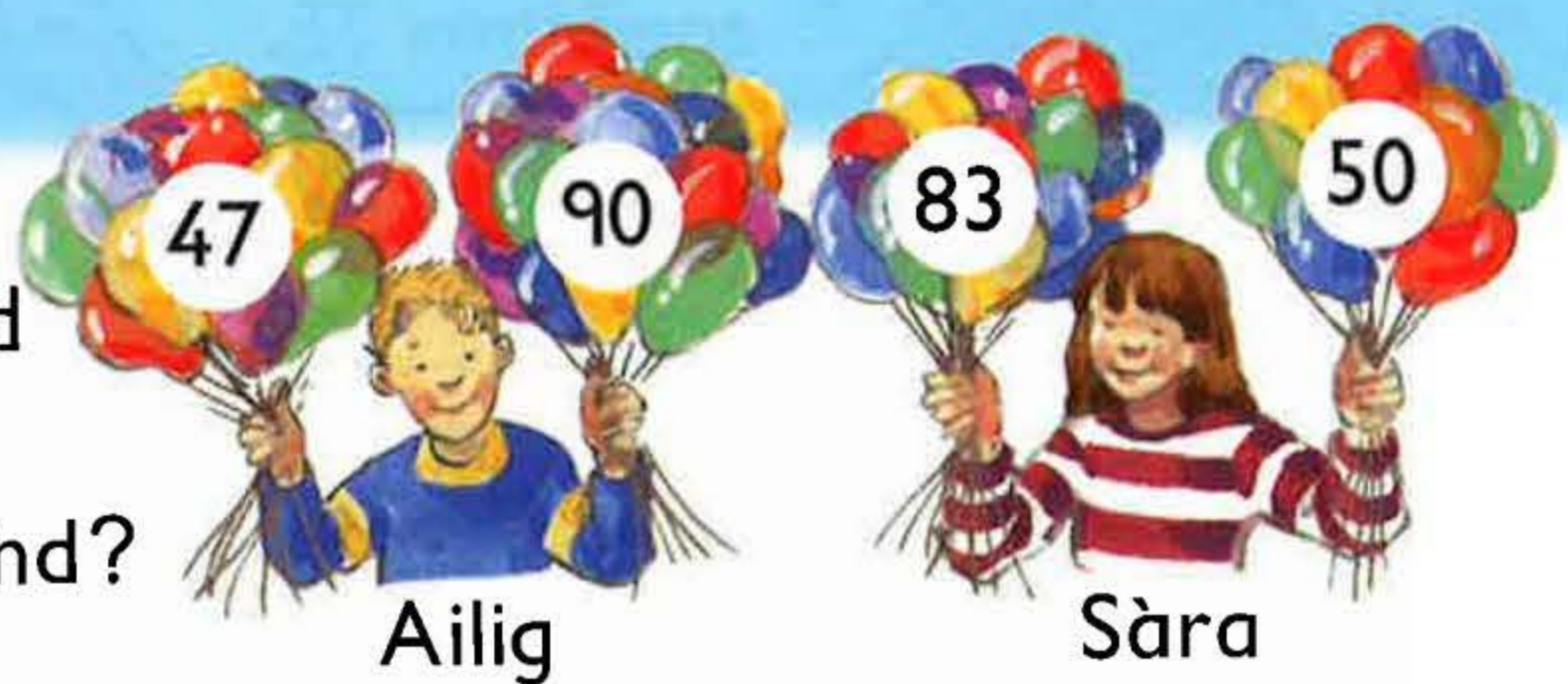

5 Tha 40 bailiùn dearg aig Tom, 85 bailiùnaichean gorma agus 30 bailiùn bùidhe. Cia mheud a tha aige gu lèir?

- 6 (a)  $63 + \blacksquare = 133$  (b)  $50 + \blacksquare = 148$  (c)  $85 + \blacksquare = 165$   
 (d)  $\blacksquare + 40 = 127$  (e)  $\blacksquare + 72 = 102$  (f)  $\blacksquare + 90 = 189$



2

1 Cuir 11 ri (a) 34 (b) 69 (c) 93

2 Cuir 9 ri (a) 48 (b) 75 (c) 96

3

(a) $56 + 30$	(b) $56 + 31$	(c) $56 + 29$
(d) $50 + 84$	(e) $51 + 84$	(f) $49 + 84$

4 Sgrìobh gach suim.



5 (a)  $95 + 21$  (b)  $79 + 33$  (c)  $46 + 71$   
 (d)  $34 + 82$  (e)  $86 + 48$  (f)  $62 + 57$



6 Cia mheud neach-siubhail a chaidh gu:

- (a) Lunnainn
- (b) Paris
- (c) Obar Dheathain
- (d) Birmingham?

		Àireamh luchd-siubhail	
		Inbhich	Clann
<input checked="" type="radio"/>	Lunnainn	84	49
<input checked="" type="radio"/>	Paris	73	41
<input checked="" type="radio"/>	Obar Dheathain	82	26
<input checked="" type="radio"/>	Birmingham	91	58



12



1 Cia mheud neach-siubhail a tha air na busaichean seo gu lèir?  
 (a) uaine agus dearga (b) gorma agus buidhe  
 (c) buidhe agus uaine (d) uaine agus gorma

- 2 (a)  $54 + 62$  (b)  $73 + 95$  (c)  $36 + 83$   
 (d)  $77 + 44$  (e)  $65 + 76$  (f)  $57 + 48$

3 Lorg prìs gach paidhir de thiceadan.

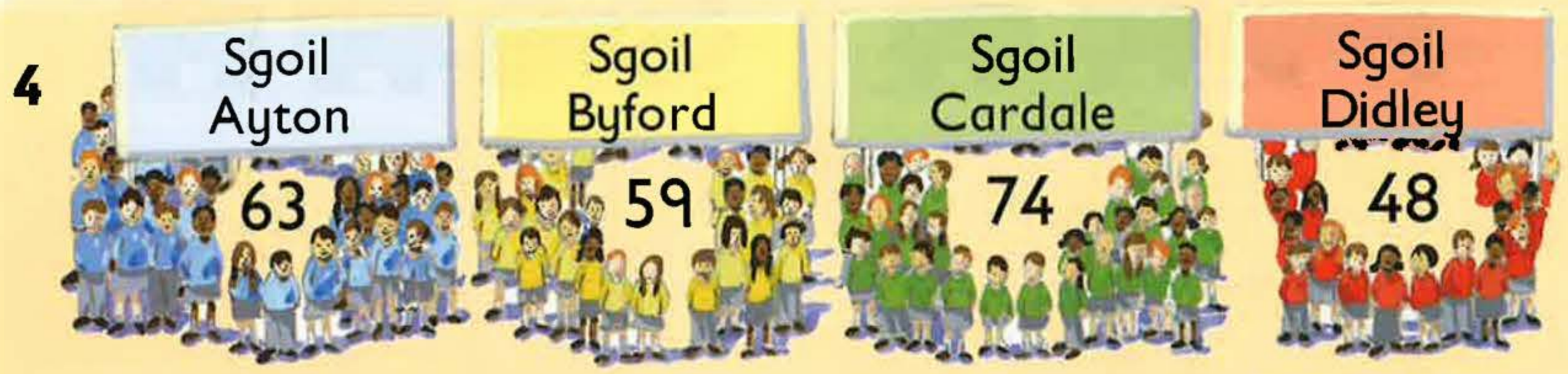

Dè an dà sgoil a lìonas am bus

- (a) donn  
 (b) geal gu h-iomlan?



- 5 (a)  $43 + \blacksquare = 126$  (b)  $57 + \blacksquare = 139$   
 (c)  $85 + \blacksquare = 113$  (d)  $49 + \blacksquare = 124$





2  
1 Cuir na suimean anns na pocannan de na h-aon dathan ri chèile.



2 Dè an t-suim a tha anns gach preas?

(a)



(b)



(c)



(d)



3

(a)  $£340 + £\blacksquare = £390$

(b)  $£\blacksquare + £425 = £445$

(c)  $£363 + £\blacksquare = £390$

4

(a)  $416 + 20$     (b)  $416 + 19$

(c)  $444 + 29$     (d)  $623 + 39$

(e)  $546 + 9$     (f)  $705 + 69$

(g)  $364 + 18$     (h)  $866 + 28$

(i)  $305 + 57$     (j)  $414 + 77$

5

(a)  $353 + 40$     (b)  $353 + 41$

(c)  $666 + 31$     (d)  $507 + 51$

(e)  $258 + 11$     (f)  $715 + 41$

(g)  $224 + 22$     (h)  $532 + 62$

(i)  $818 + 83$     (j)  $931 + 63$



## Bogsa airgid £££



1 Cuir na meudan air na cèisean seo ri chèile:

- (a) cèisean uaine      (b) cèisean gorma      (c) cèisean dearga  
 (d) cèisean buidhe      (e) cèisean geala      (f) cèisean donna.

2 Sgrìobh an t-suim airgid anns gach paidhir de phocannan.



3

(a)  $370 + \blacksquare = 440$

(b)  $\blacksquare + 160 = 230$

(c)  $650 + \blacksquare = 690$

(d)  $586 + \blacksquare = 626$

(e)  $\blacksquare + 183 = 203$

(f)  $829 + \blacksquare = 919$



1 Dùblaich gach àireamh.



2 Sgrìobh gach àireamh bhon lèine dheirg còmhla ris an dùblachadh aice bhon lèine uaine.



3

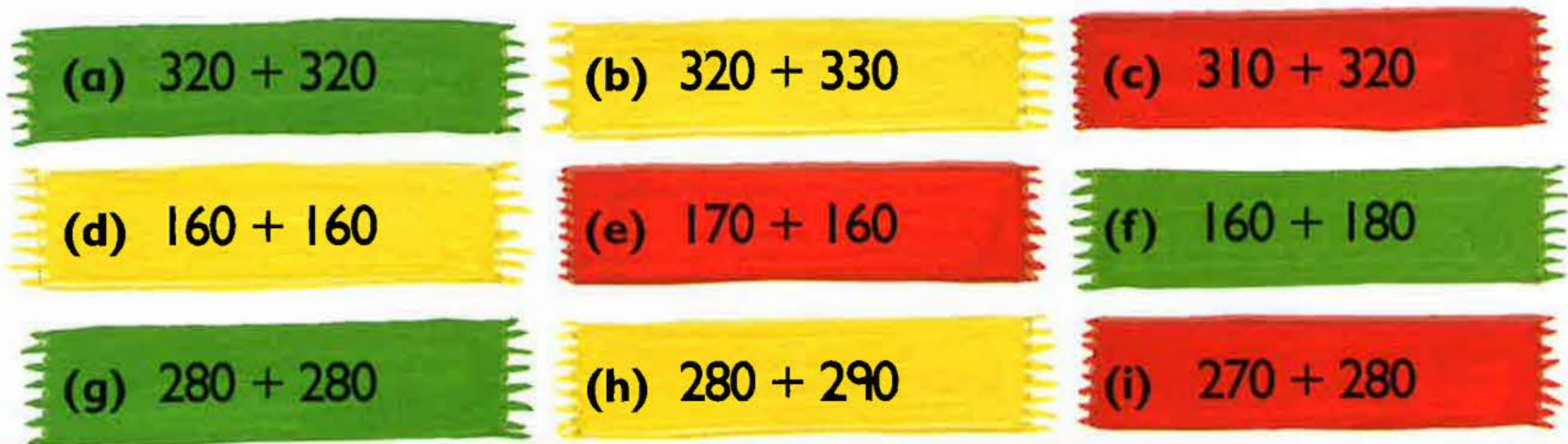

4

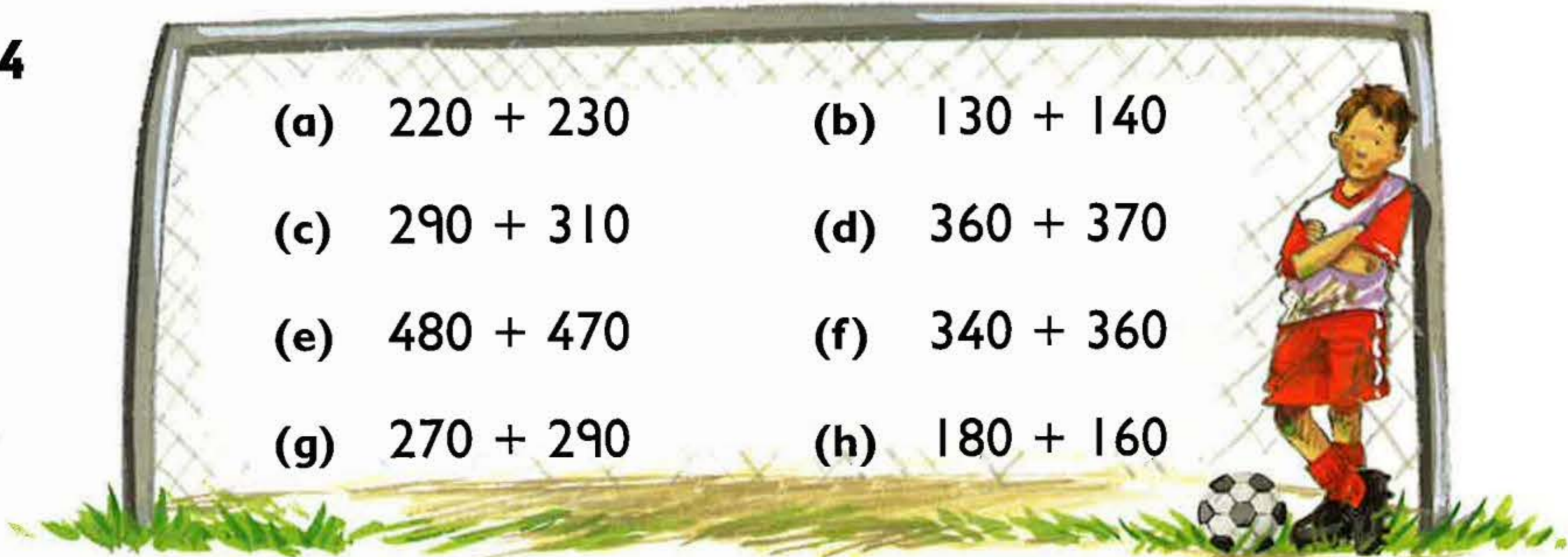



2 Dè an àireamh bho na bàllaichean a tha air a chur ri:

- (a) 170 gus 200 fhaighinn
- (b) 440 gus 500 fhaighinn
- (c) 865 gus 900 fhaighinn
- (d) 572 gus 600 fhaighinn
- (e) 284 gus 300 fhaighinn
- (f) 309 gus 400 fhaighinn?

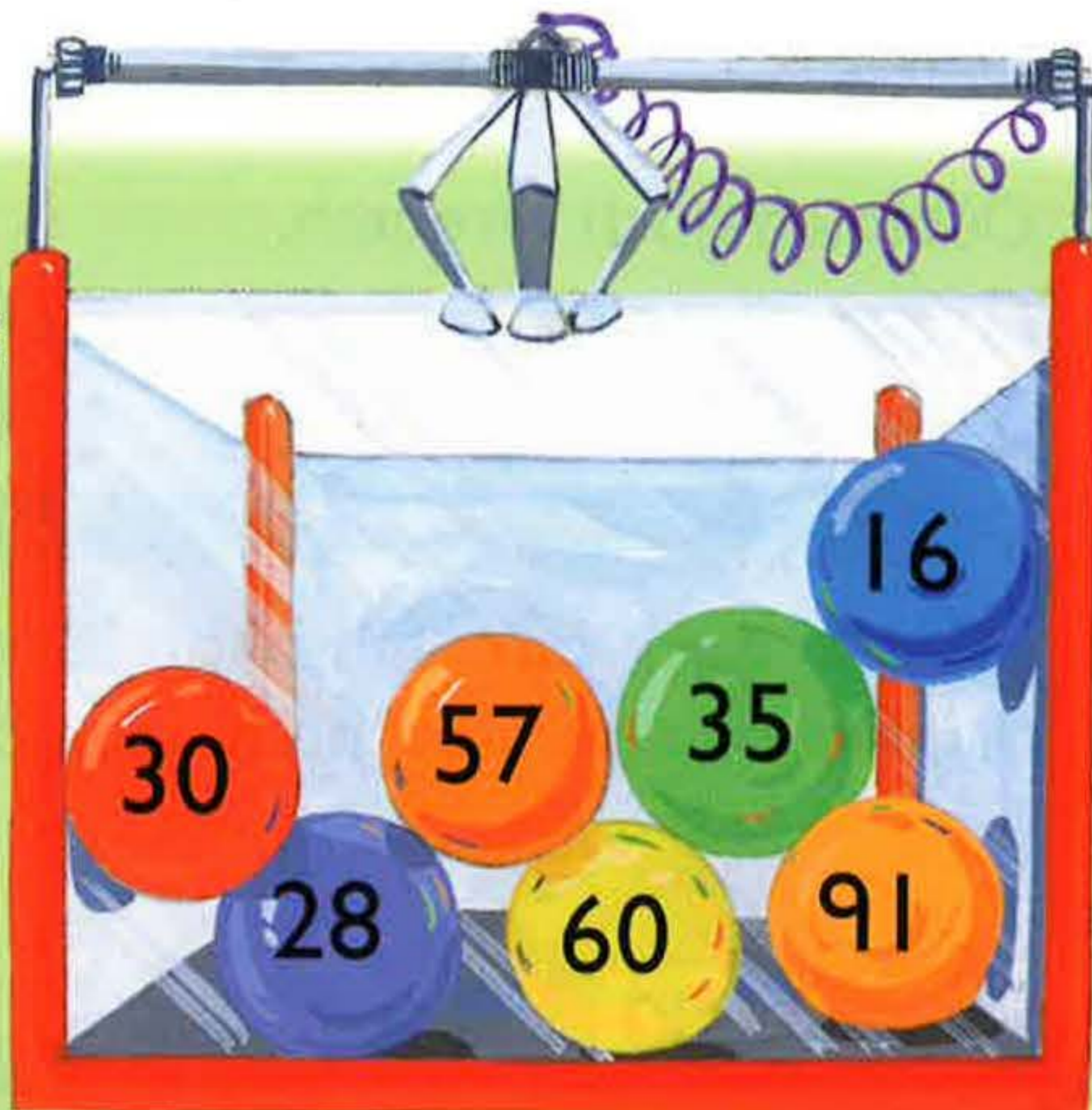

2 Cia mheud eile a dh'fheumas tu gus gach bogsa a lìonadh?

(a)



(b)



3 Cia mheud eile a dh'fheumas tu gus na sileagain a lìonadh?

(a)



(b)



(c)



(d)



- 4 (a)  $110 + \blacksquare = 200$  (b)  $560 + \blacksquare = 600$  (c)  $819 + \blacksquare = 900$   
 (d)  $\blacksquare + 668 = 700$  (e)  $\blacksquare + 721 = 800$  (f)  $\blacksquare + 985 = 1000$



1 Dè an doras a tha gach iuchar a' fosgladh?



(a) Dùblaich 90, cuir-ris 90

(b) Dùblaich 160, cuir-ris 45

(c) 200 a bharrachd air dùblachadh 130

(d) Dùblachadh 65, cuir-ris dùblachadh 70

2 Cleachd ceithir de na h-àireamhan gus sgeulachd a' chur-ris a dhèanamh fìor.

37 59 64 71 93      ■ + ▲ = ○ + ◆

3

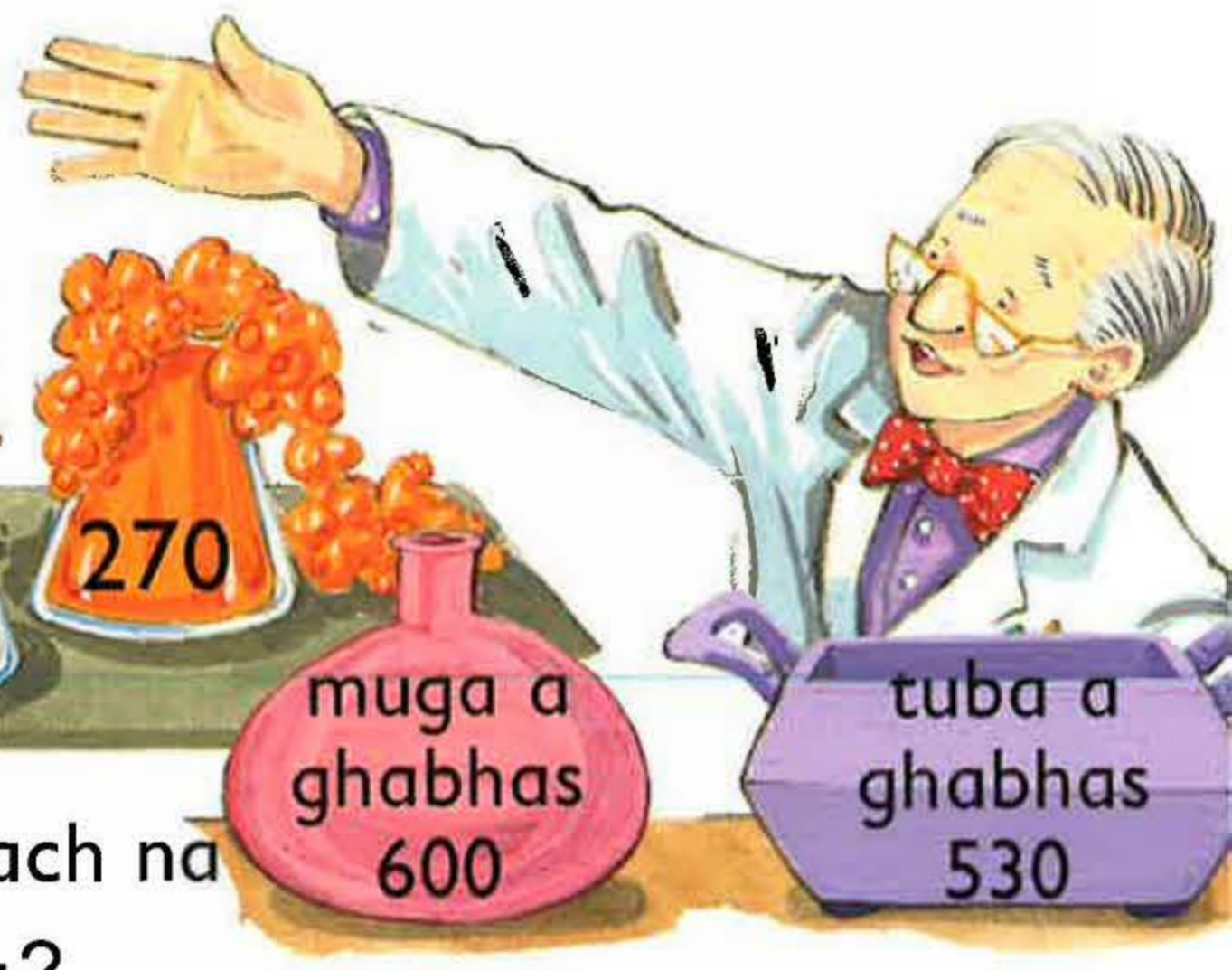

Dè an dà dhath a bheir dhut dìreach na (a) lìonas muga (b) lìonas tuba?

4 Cia mheud eile a dh'fheumadh tu gus a' phoit a lìonadh?

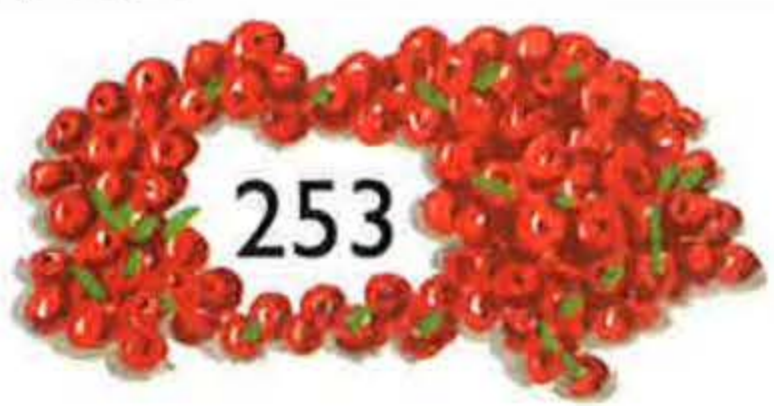



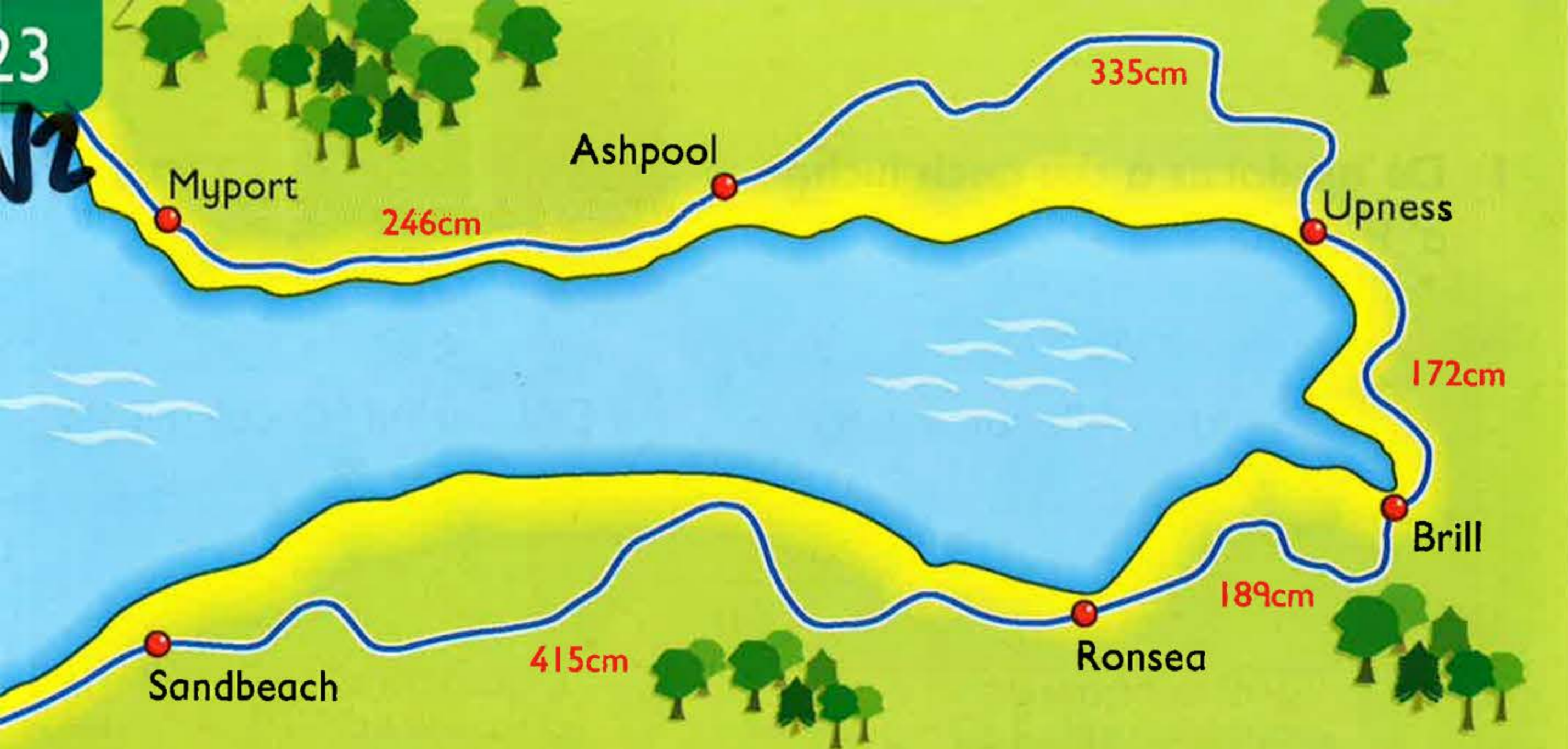

1 Dè an t-astar a tha air an rathad eadar:

- (a) Myport agus Upness      (b) Ashpool agus Brill  
 (c) Upness agus Ronsea      (d) Brill agus Sandbeach?

Cia mheud cileameatair a tha ann faighinn **air ais 's air adhart** eadar:

- (a) Myport agus Ashpool      (b) Brill agus Ronsea?

- 3 (a)  $557 + 434$       (b)  $173 + 660$       (c)  $258 + 476$   
 (d)  $397 + 545$       (e)  $558 + 289$       (f)  $679 + 273$   
 (g)  $765 + 135$       (h)  $209 + 296$       (i)  $144 + 586$

4



Tha an taigh agamsa eadar Ashpool agus Upness. Tha e 176cm à Ashpool agus 159cm à Upness.

Dè cho fada 's a tha taigh Ryan à

- (a) Myport      (b) Brill?



## Seachdain na Fèille

- 1 Dè an sgioba a thog an t-suim airgid  
(a) bu mhotha (b) bu lugha?

Clas 4 Geamannan Teanas bùird			
Sgioba dearg	Sgioba gorm	Sgioba uaine	Sgioba purpaidh
Lee £239	Cara £183	Greg £239	Emma £239
Phil £239	Zoe £239	Sally £239	Raja £239

- 2 Lorg an t-suim airgid a chaidh a thogail le na spòrsan seo.  
(a) (b)

Clas 4 Snàmh	
Ainm	Suim
Mandy	£249
Bill	£217
Ros	£235
Rashmi	£172
Paul	£88

Clas 4 Rothaireachd	
Ainm	Suim
Anwar	£206
Mark	£187
Kim	£92
Jo	£265
Sam	£250

- 3 Cò an dithis a thog dìreach:  
(a) £180 (b) £500?
- 4 Dè am fear de na trì **spòrsan** a thog an t-suim:  
(a) bu mhotha (b) bu lugha?



Cia mhead lus a tha air fhàgail?

(a) Reic 21.

(b) Reic 19.

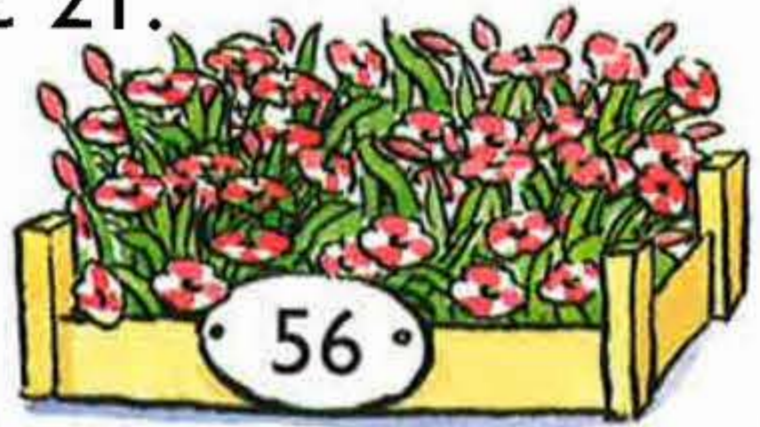

2

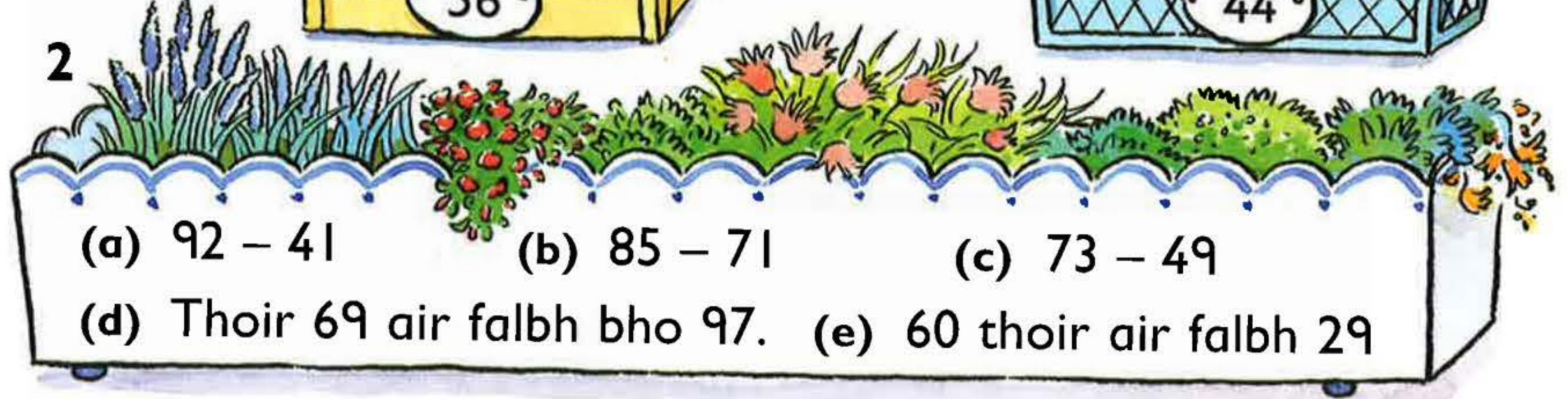

(a)  $92 - 41$

(b)  $85 - 71$

(c)  $73 - 49$

(d) Thoir 69 air falbh bho 97. (e) 60 thoir air falbh 29

3 Cia mhead lus a tha air fhàgail?

(a) Reic 22.

(b) Reic 22.

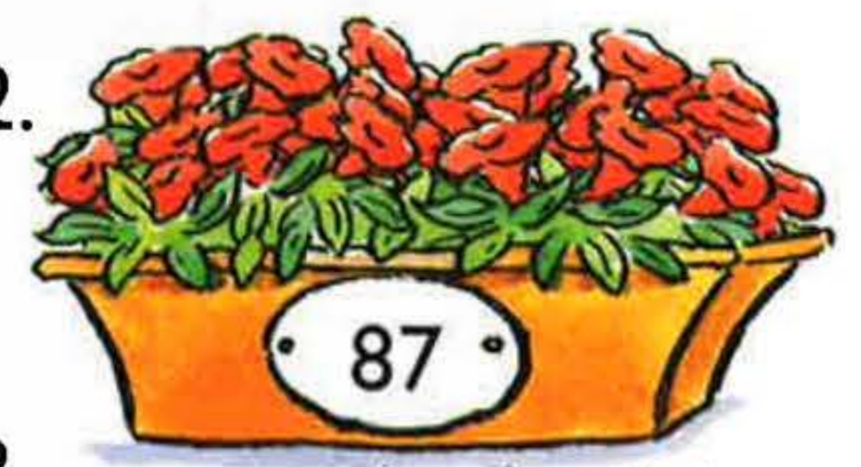
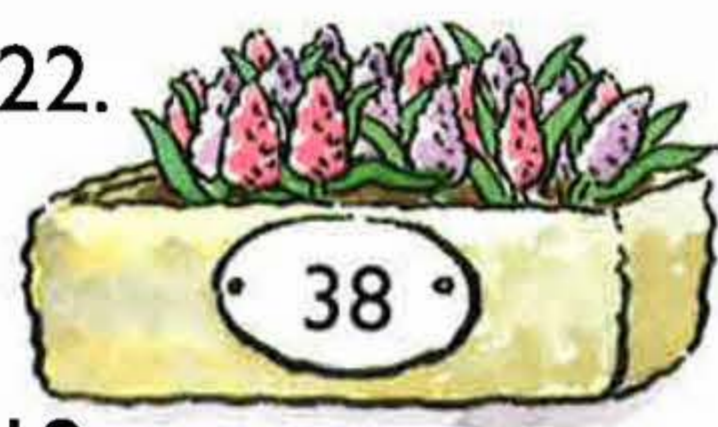

(c) Reic 18.

(d) Reic 18.

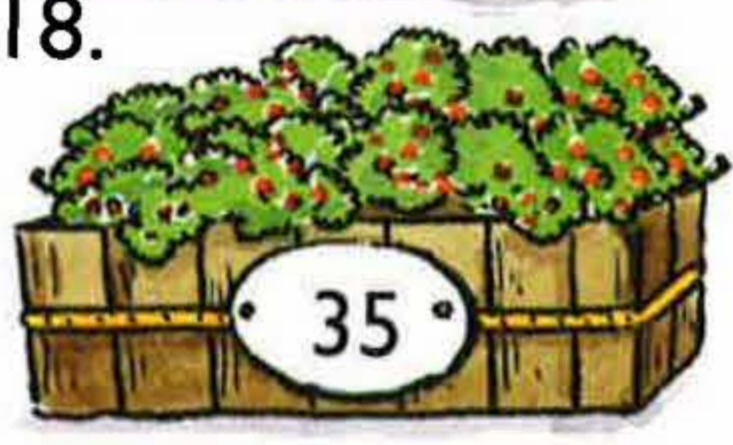

4

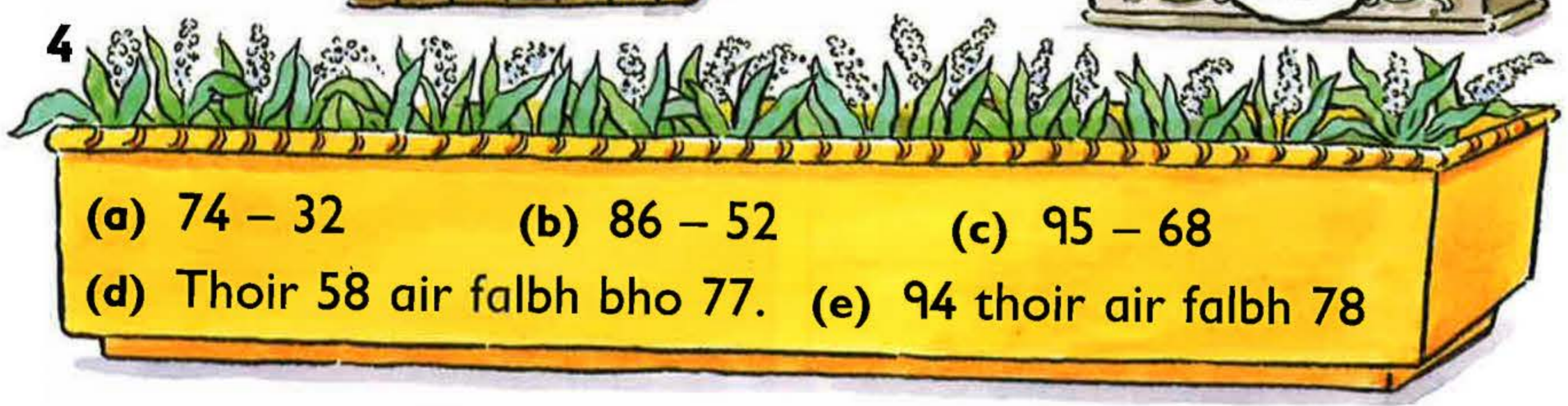

(a)  $74 - 32$

(b)  $86 - 52$

(c)  $95 - 68$

(d) Thoir 58 air falbh bho 77. (e) 94 thoir air falbh 78

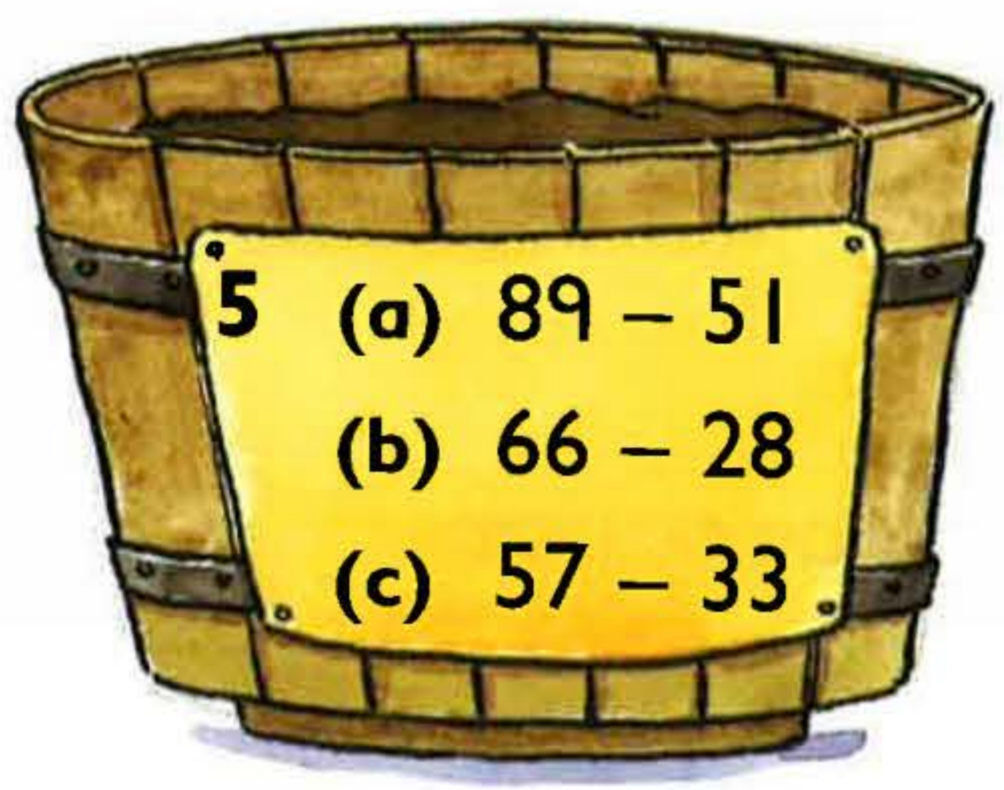

5 (a)  $89 - 51$

(b)  $66 - 28$

(c)  $57 - 33$

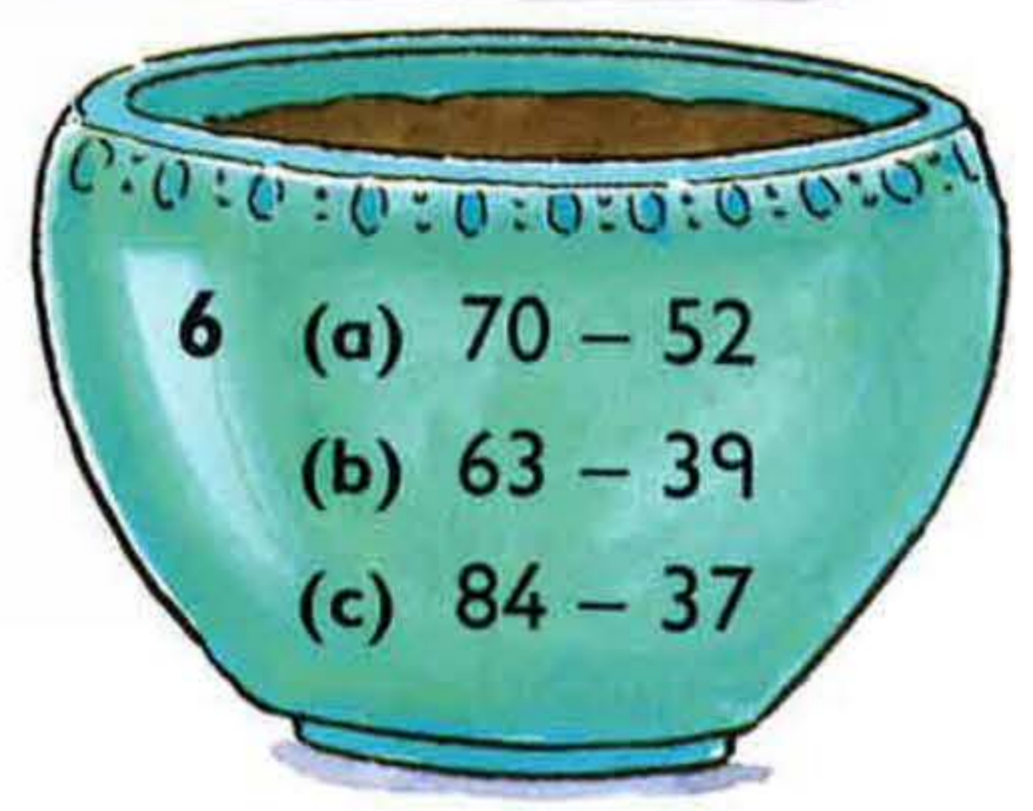

6 (a)  $70 - 52$

(b)  $63 - 39$

(c)  $84 - 37$



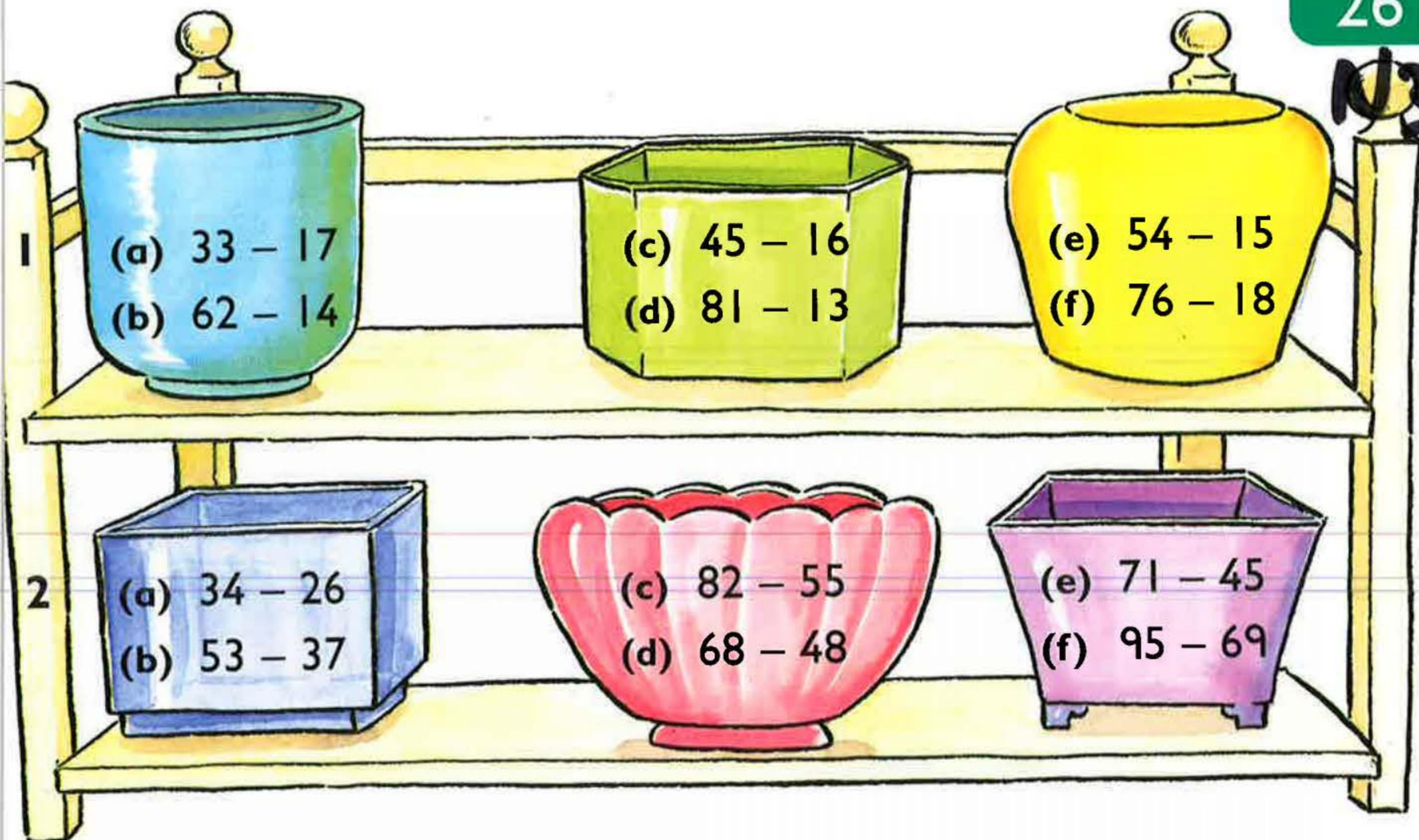

3 Lorg an diofar ann am prìsean nam:

- (a) poitean uaine agus buidhe  
(b) poitean donna agus uaine  
(c) poitean donna agus buidhe  
(d) poitean dearga agus uaine.

4 Dè na tha a' phoit as daoire a' cosg a bharrachd air a' phoit as saoire?

5 Tha £15 air a thoirt far prìs gach poit.  
Sgrìobh prìs ùr gach poit.



6 (a)  $76 - \blacksquare = 48$

(b)  $55 - \blacksquare = 28$

(c)  $64 - \blacksquare = 26$



3 Ath-sgrìobh agus crìochnaich obair gach sgoilear.

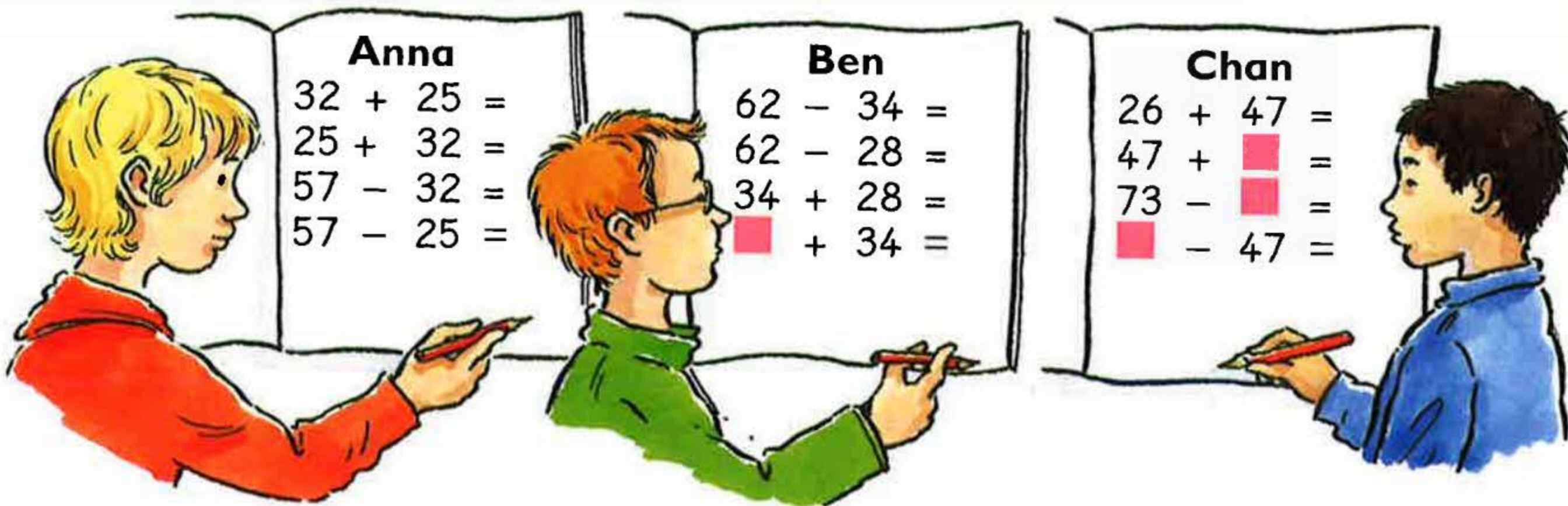

2 Sgrìobh 2 sgeulachd cur-ris agus 2 sgeulachd toirt air falbh, a' cleachdadh gach seata de thrì àireamhan.

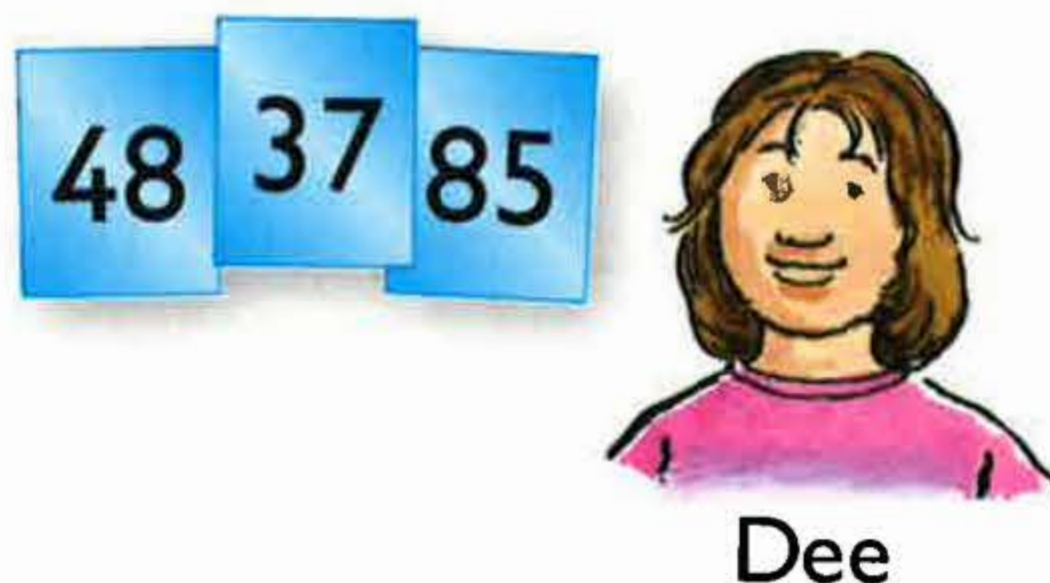

3 (a) Cò a tha air toirt air falbh gu ceart?  
Dèan cinnteach le bhith a' cur-ris.



(b) Airson gach toirt air falbh ceart, sgrìobh:

- an cur-ris a chleachd thu gus dèanamh cinnteach
- cur-ris eile a dh'fhaodadh tu chleachdadh airson dèanamh cinnteach



1 Sgrìobh na h-àireamhan a tha: (a) cothromach (b) còrr

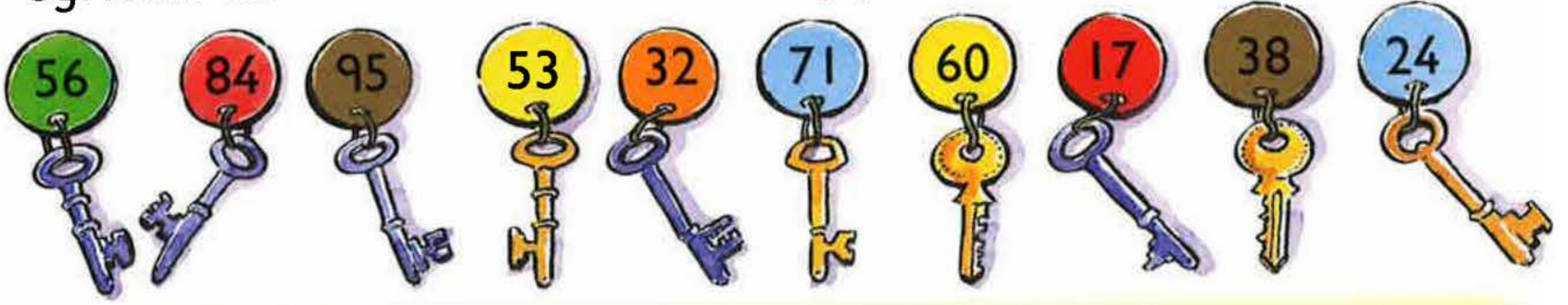

2 Lorg an diofar eadar na h-àireamhan air na cearcaill seo.

- (a) dearg agus orains (b) donn agus buidhe  
 (c) gorm agus buidhe (d) orains agus gorm  
 (e) dearg agus uaine (f) donn agus dearg



3 (a) Dè an seòrsa àireamh a tha anns gach freagairt ann an ceist 2?

(b) Dè tha thu a' mothachadh nuair a lorgas tu an diofar eadar dà àireamh **chothromach**?

4 Lorg an diofar eadar na h-àireamhan air na cearcaill seo.

- (a) orains agus uaine (b) gorm agus buidhe  
 (c) buidhe agus donn (d) donn agus orains  
 (e) buidhe agus uaine (f) dearg agus gorm

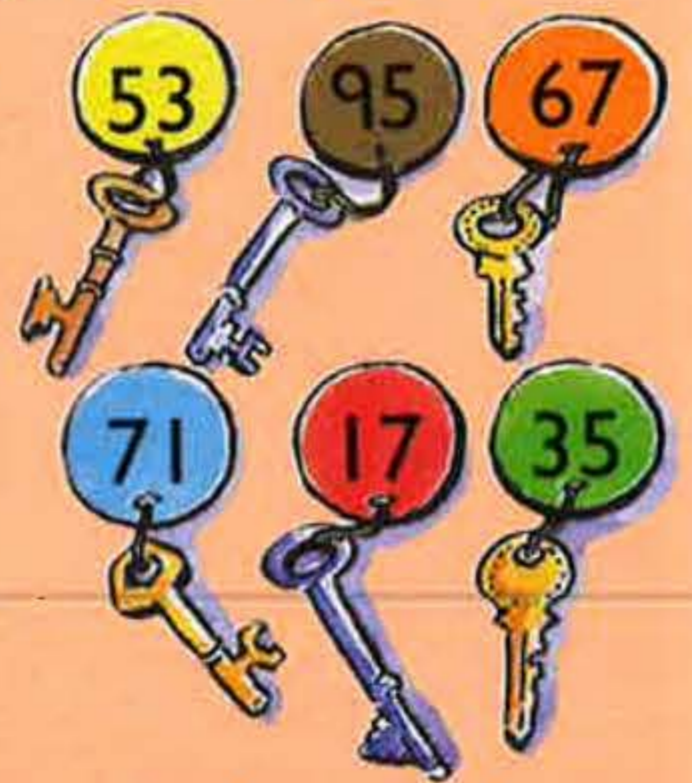

5 (a) Dè an seòrsa àireamh a tha anns gach freagairt ann an ceist 4?

(b) Dè tha thu a' mothachadh nuair lorgas tu an diofar eadar àireamhan **corra**?

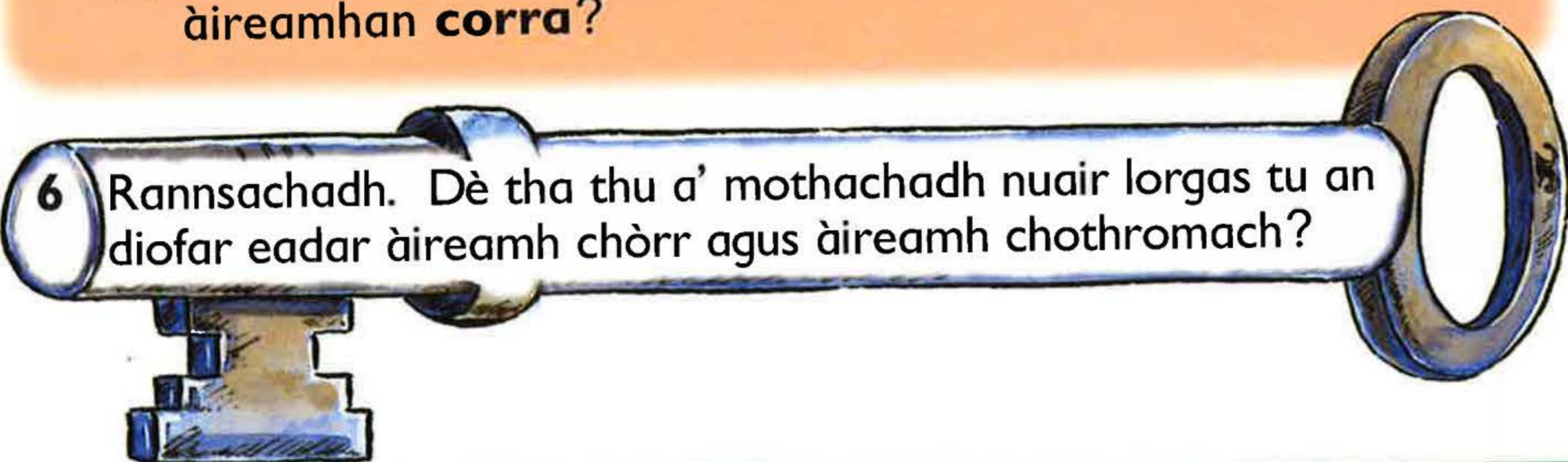

6 Rannsachadh. Dè tha thu a' mothachadh nuair lorgas tu an diofar eadar àireamh chòrr agus àireamh chothromach?



N3

Dè na tha aca air fhàgail?

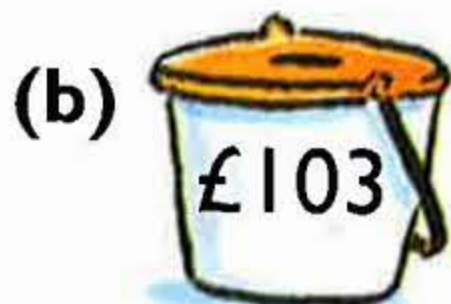

Thoir £7 don RSPCA. Thoir seachad £4.



Thoir seachad £6. Thoir seachad £5.

Thoir seachad £9.

2 (a)  $300 - 7$

(b)  $605 - 6$

(c)  $502 - 4$

(d)  $701 - 8$

(e)  $207 - 9$

(f)  $904 - 6$

(g)  $906 - \blacksquare = 897$

(h)  $803 - \blacksquare = 798$

(i)  $408 - \blacksquare = 399$

3 Dè na tha aig gach duine air fhàgail?



Thoir £7 don RSPCC.

Thoir £8 seachad.

Thoir £9 seachad.



Thoir £5 seachad.

Thoir £4 seachad.

Thoir £8 seachad.

4 (a) Thoir 7 air falbh bho 323.

(b) Thoir 9 bho 545.

(c) 215 thoir air falbh 7

(d) 652 thoir air falbh 7

(e) 5 nas lugha na 730

(f) 461 thoir air falbh 3





1 Cia mheud a tha air fhàgail an dèidh dhaibh seo bhith air an reic?

- (a) 80 leabhar (b) 90 cairt (c) 60 iris  
 (d) 80 dèideag (e) 40 putan (f) 70 CD

- 2 (a)  $132 - 40$  (b)  $175 - 90$  (c)  $121 - 30$   
 (d)  $144 - 80$  (e)  $113 - 70$  (f)  $158 - 60$   
 (g)  $166 - \blacksquare = 86$  (h)  $110 - \blacksquare = 60$  (i)  $127 - \blacksquare = 67$

3 Lorg an diofar eadar:



- 4 (a) 18 nas lugha na 111 (b) Thoir 12 bho 105.  
 (c) 117 thoir air falbh 23 (d) 108 thoir air falbh 27  
 (e) Thoir 38 air falbh bho 125. (f) 127 thoir air falbh 32

5 Lorg 6 paidhrichean de dh'àireamhan eadar 60 agus 140 anns a bheil eadar-dhealachadh de 49.



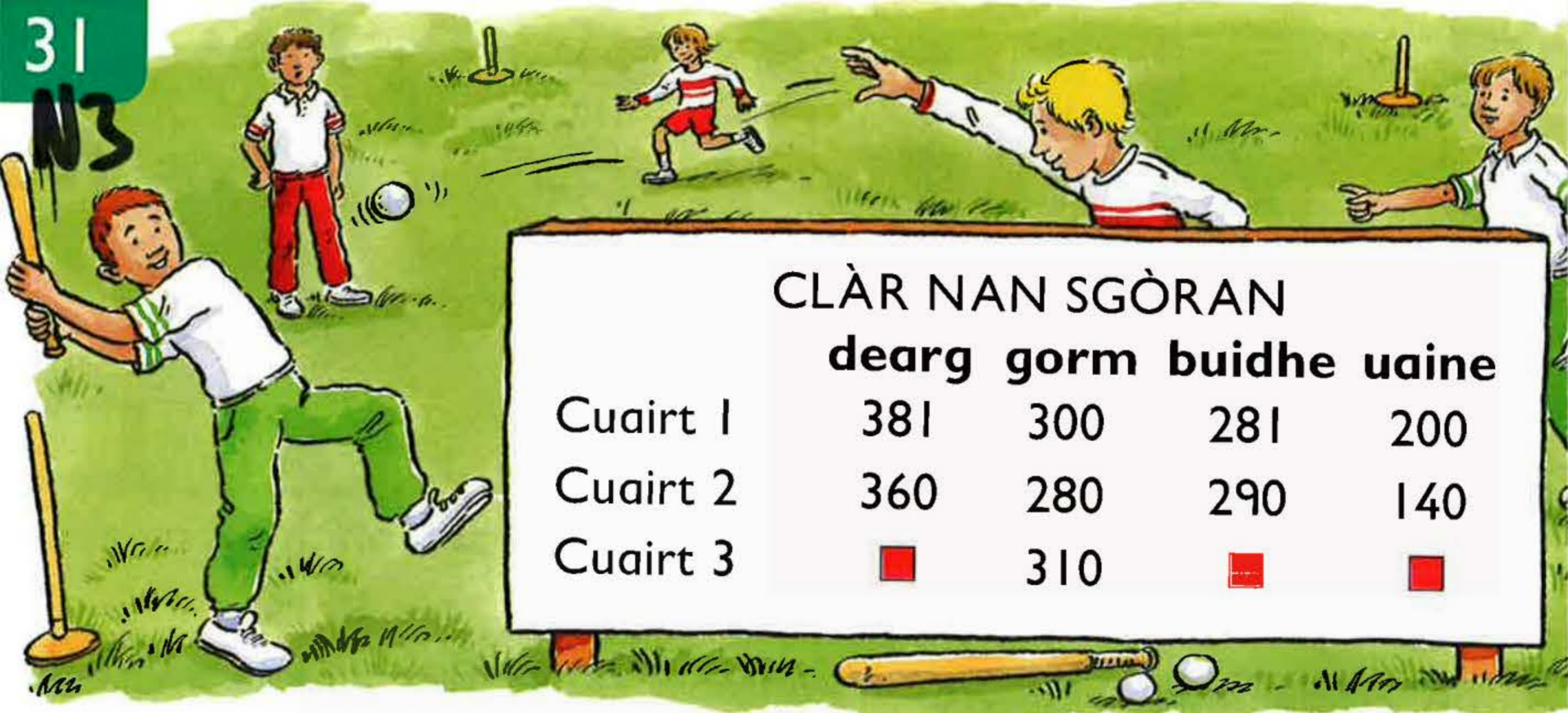

- Lorg an diofar eadar sgòran nan sgiobaidhean seo ann an **cuairt 1**
  - gorm agus uaine
  - dearg agus buidhe
  - buidhe agus gorm
  - uaine agus dearg.
- Lorg an diofar eadar sgòran nan sgiobaidhean seo ann an **cuairt 2**
  - dearg agus buidhe
  - uaine agus gorm
  - gorm agus dearg
  - buidhe agus uaine.
- Lorg sgòran gach sgioba ann an **cuairt 3**.
  - Sgòr an sgioba uaine 90 nas lugha na an sgioba gorm.
  - Sgòr an sgioba uaine 150 nas lugha na an sgioba dearg.
  - Sgòr an sgioba dearg 120 a bharrachd air an sgioba bhuidhe.
- Dè an sgioba aig an robh **suim** nan sgòran
  - a b' àirde
  - a b' ìsle?
- (a)  $430 - \blacksquare = 310$       (b)  $580 - \blacksquare = 470$       (c)  $750 - \blacksquare = 640$

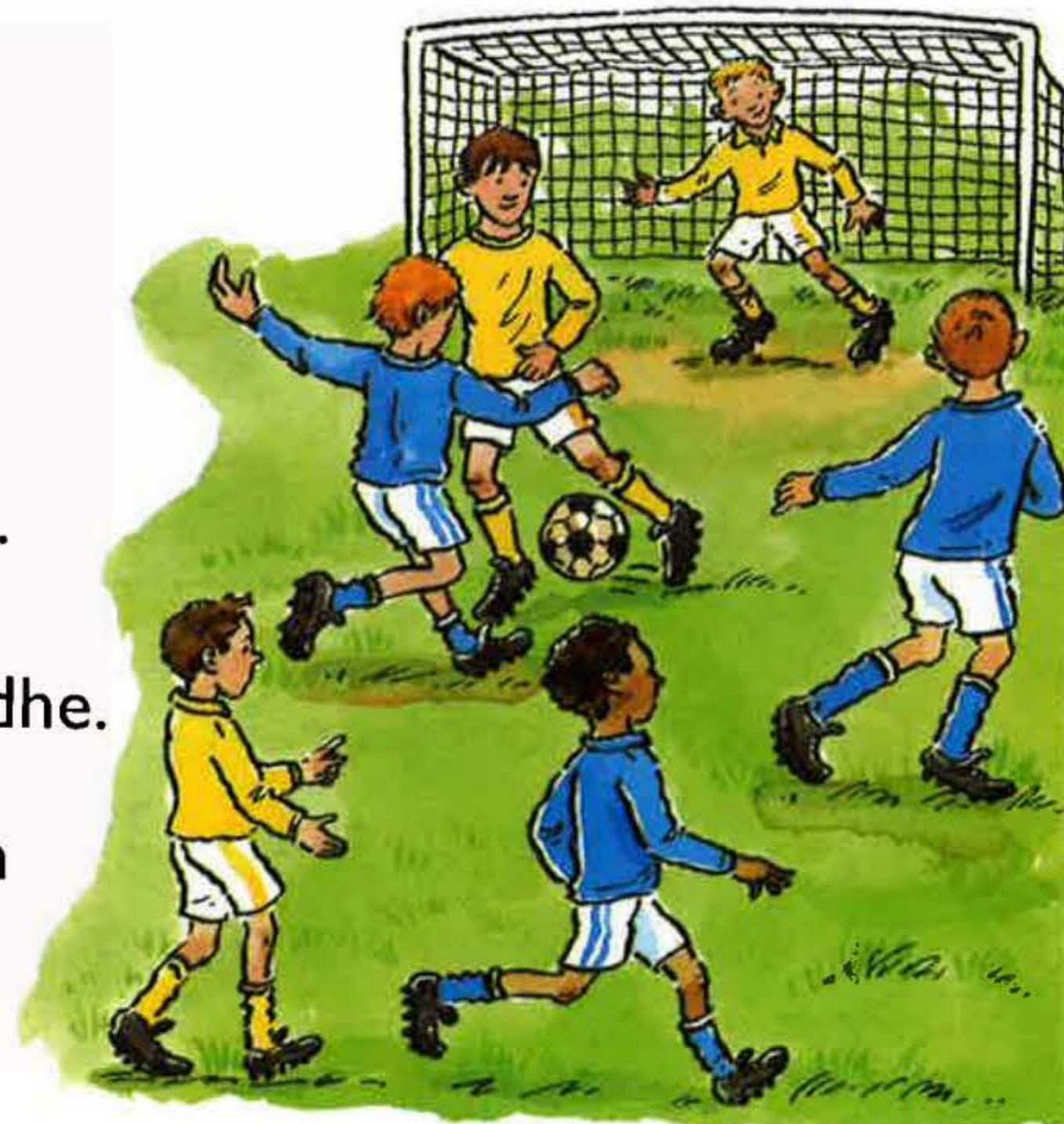





1 Tagh aon pharsail bho gach sgeilp gus paidhir a dhèanamh anns a bheil diofar de:

- (a) £8                      (b) £200                      (c) £70                      (d) £120

2 Dèan an-àirde dà phrìs le diofar £38 a chuireas tu air na parsailean dearga.

3 Dè na bha aig gach duine de dh'airgead aig an toiseach?

(a)  Chosg mi £18.  
Tha £287 air fhàgail agam

(b)  Chosg mi £160.  
Tha £410 air fhàgail agam

4 Dè na tha aig gach duine air fhàgail?

(a)  Thòisich mi le £1000.  
Chosg mi £400.  
Thug mi seachad £240.  
Chail me leth de na bha air fhàgail.

(b)  Thòisich mi le £900.  
Thug mi seachad £150.  
Chosg mi £350.  
Ghlèidh mi cairteal de na bha air fhàgail.



N3

Cleachd trì de na figearan seo gach turas.  
Ath-sgrìobh agus crìochnaich.

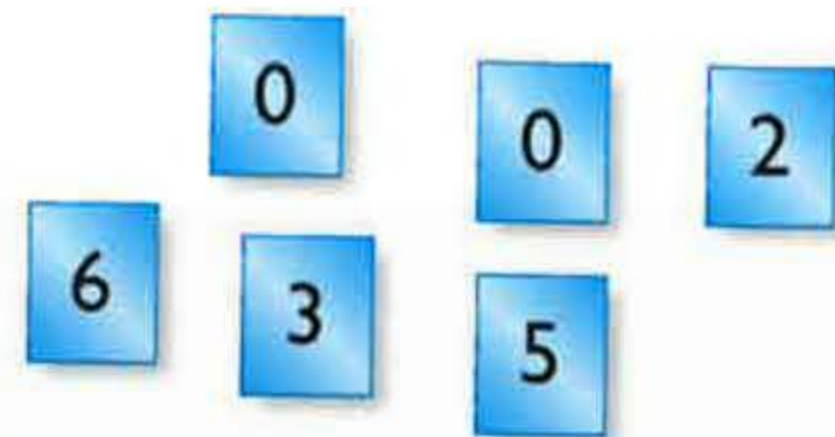

(a)  $\square\square\square - 400 = 252$     (b)  $2\square 0 - 1\square\square = 130$

2 Cleachd na cairtean-fhigear seo.



Dèan paidhir de dh'àireamhan trì-figear anns a bheil diofar de:

(a) 220                      (b) 30                      (c) 19                      (d) 8.

3 Tha dà **Chairt cheangail** aig gach cluicheadair.

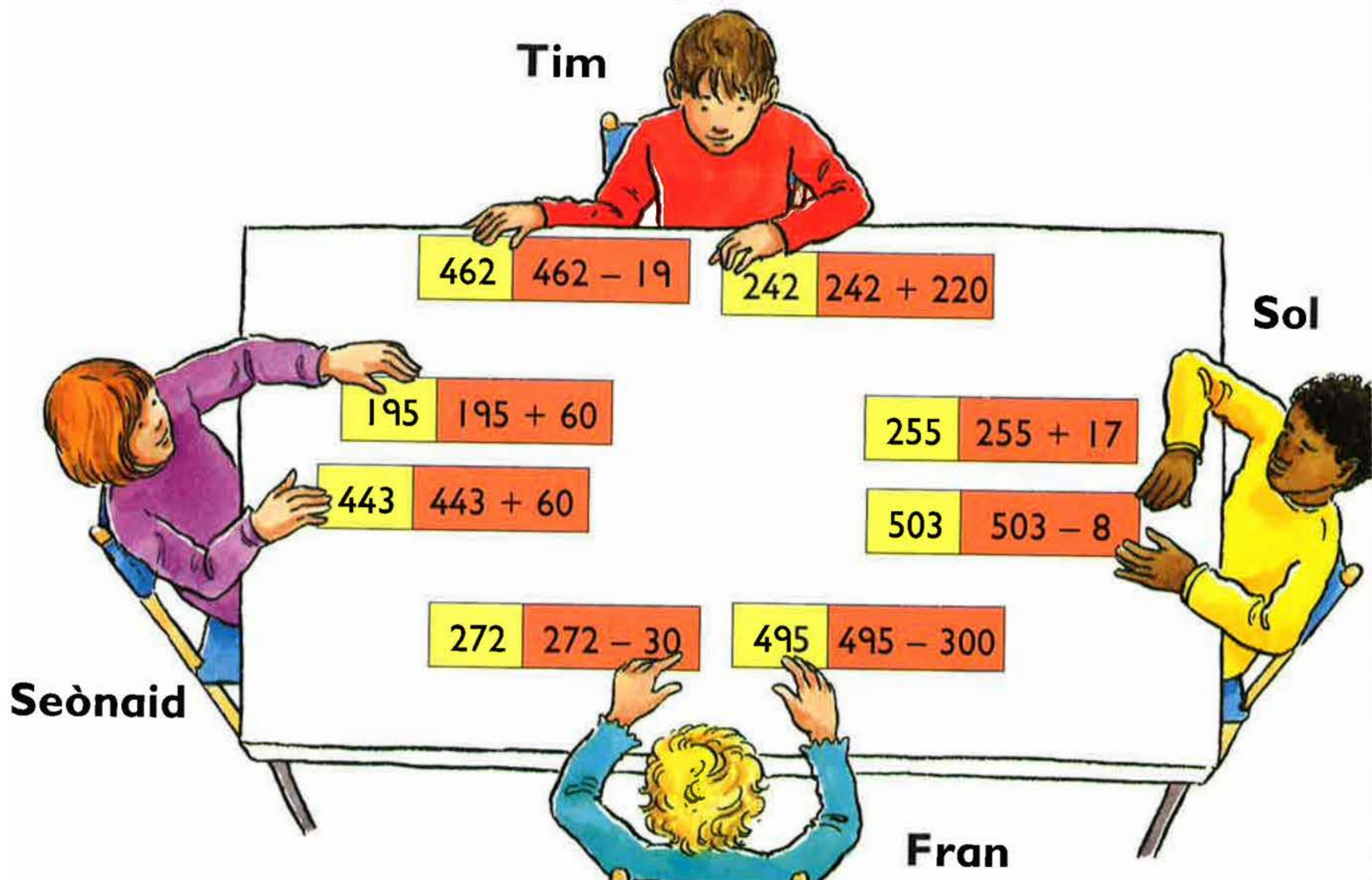

Tha Tim a' tòiseachadh le  $462$   $462 - 19$ .

Tha an cluicheadair aig a bheil am **freagairt** an-còmhnaidh a' cluich na h-ath chairte. Cò an cluicheadair a chluicheas a' chairt **mu dheireadh**?



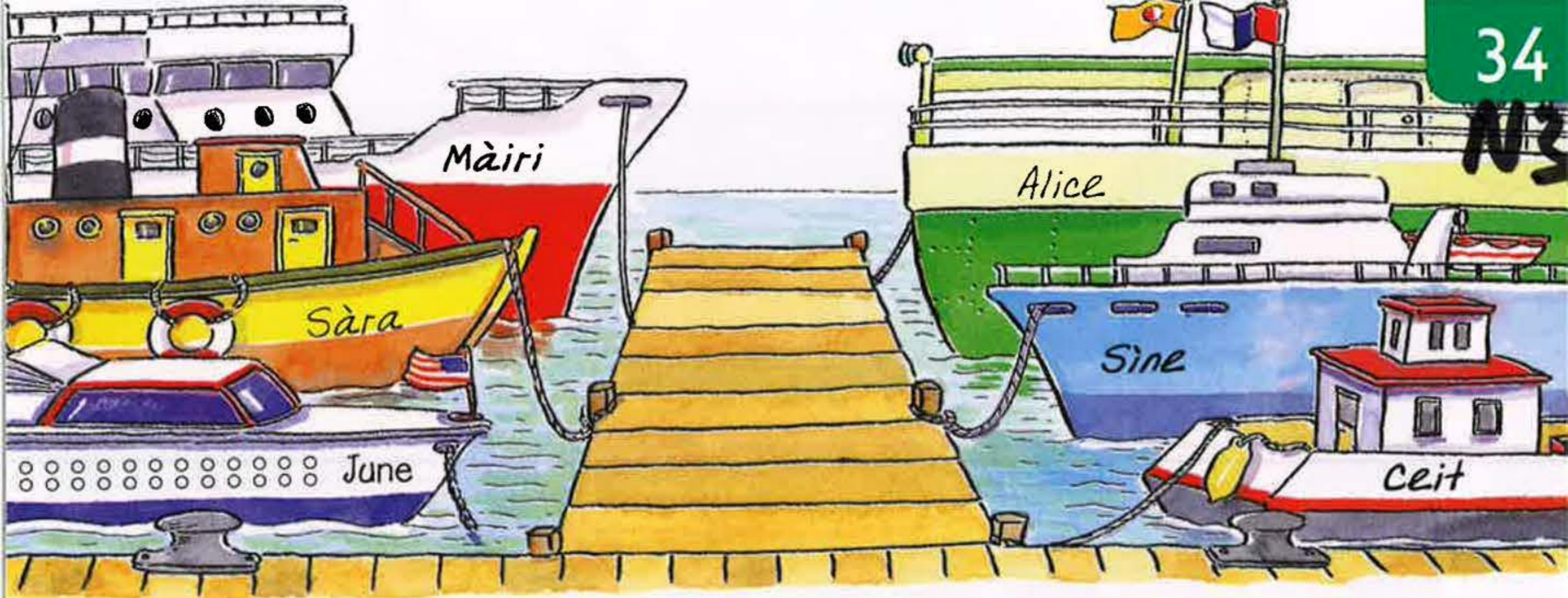

- 1 Gheibh 172 duine air bòrd *June*. Tha 31 air bòrd an-dràsta. Cia mheud duine a gheibh air bòrd fhathast?

	<i>Alice</i>	<i>Màiri</i>	<i>Sàra</i>	<i>Sine</i>	<i>Ceit</i>
A gheibh air bòrd	776	663	548	384	178
Àireamh air bord	56	48	63	92	89

- 2 Cia mheud duine a bharrachd a gheibh air bòrd iad seo?  
(a) *Alice* (b) *Màiri* (c) *Sàra* (d) *Sine* (e) *Ceit*?
- 3 Cia mheud duine a gheibh air bòrd *Alice* a bharrachd air na gheibh air:  
(a) *Màiri* (b) *Sàra* (c) *Sine* (d) *Ceit*?
- 4 Cia mheud a gheibh air *Ceit* nas lugha na gheibh air:  
(a) *Sine* (b) *Sàra* (c) *Màiri*?
- 5 Lorg an diofar eadar an àireamh dhaoine a gheibh air bòrd:  
(a) *Sàra* agus *Màiri* (b) *Sine* agus *Sàra*  
(c) *Màiri* agus *Sine*

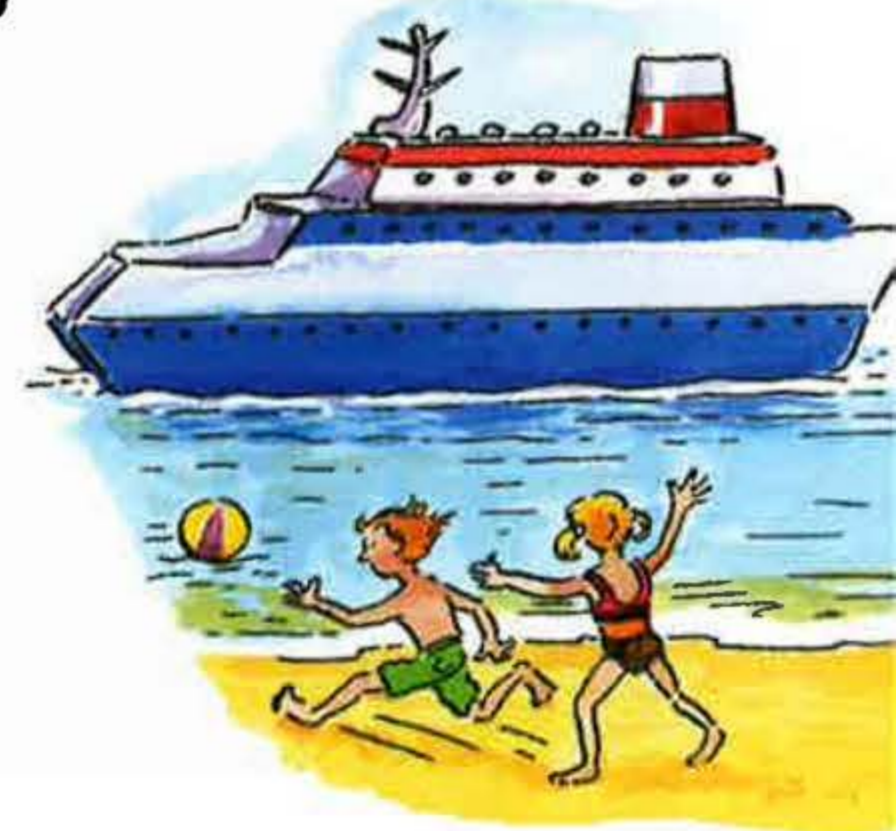



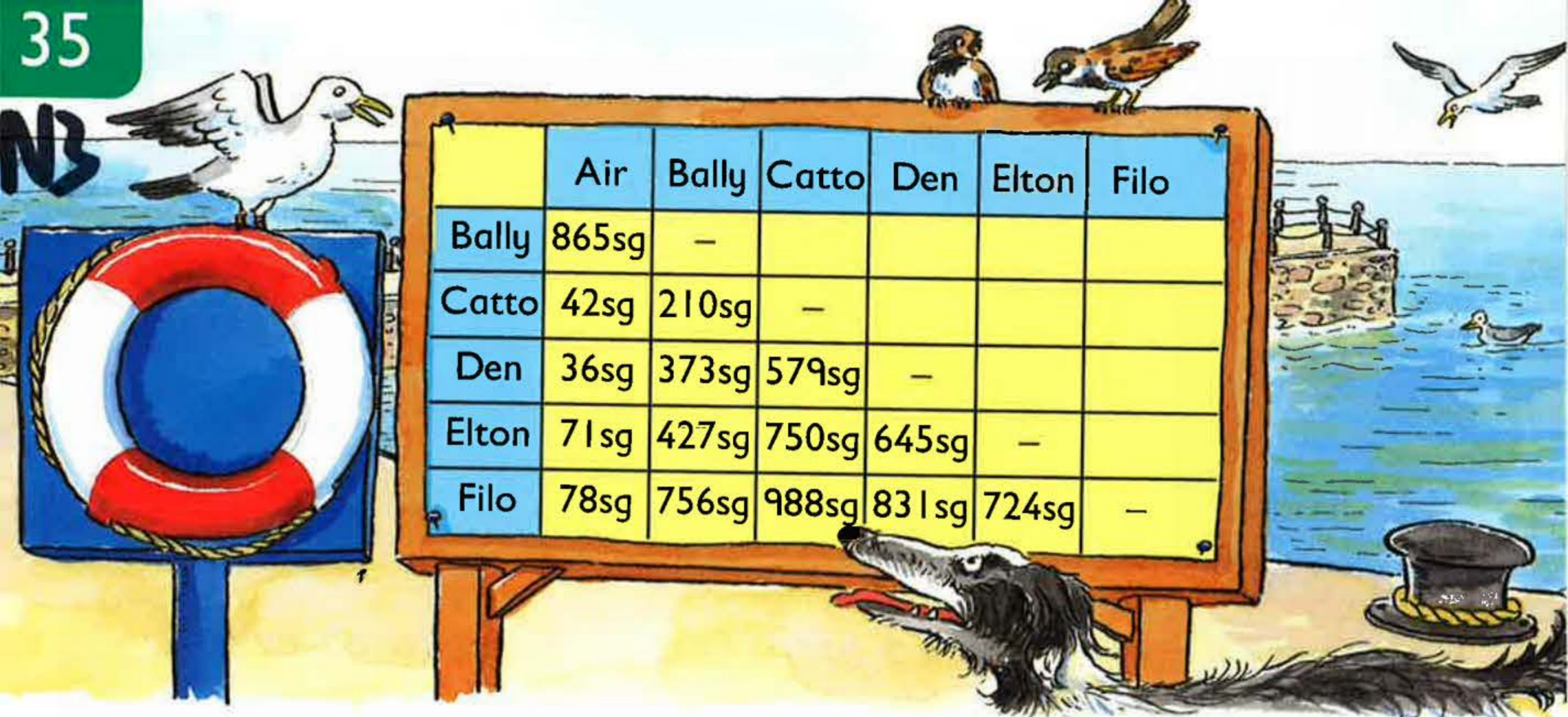

**Sgrìobh na freagairtean agaibh ann an notaichean agus sgillinnean.**

- Tha an clàr a' sealltainn prìsean nan ticeadan airson turais-bhàta. Dè a' phrìs a tha an turas eadar:
  - Air agus Den
  - Bally agus Elton
  - Filo agus Catto
  - Elton agus Air?
- Dè na tha an turas bho Air gu Bally nas daoire na bho Air gu:
  - Catto
  - Den
  - Elton
  - Filo?
- Lorg an diofar ann am prìs an turais bho Bally gu Filo agus prìs an turais bho:
  - Bally gu Catto
  - Bally gu Den
  - Bally gu Elton.
- Dè na tha an turas bho Catto gu Den nas saoire na an turas bho Catto gu:
  - Elton
  - Filo?
- Dè an diofar a tha ann am prìsean nan tursan seo?
  - Den gu Elton agus Den gu Filo
  - Den gu Elton agus Elton gu Filo
  - Den gu Filo agus Elton gu Filo.





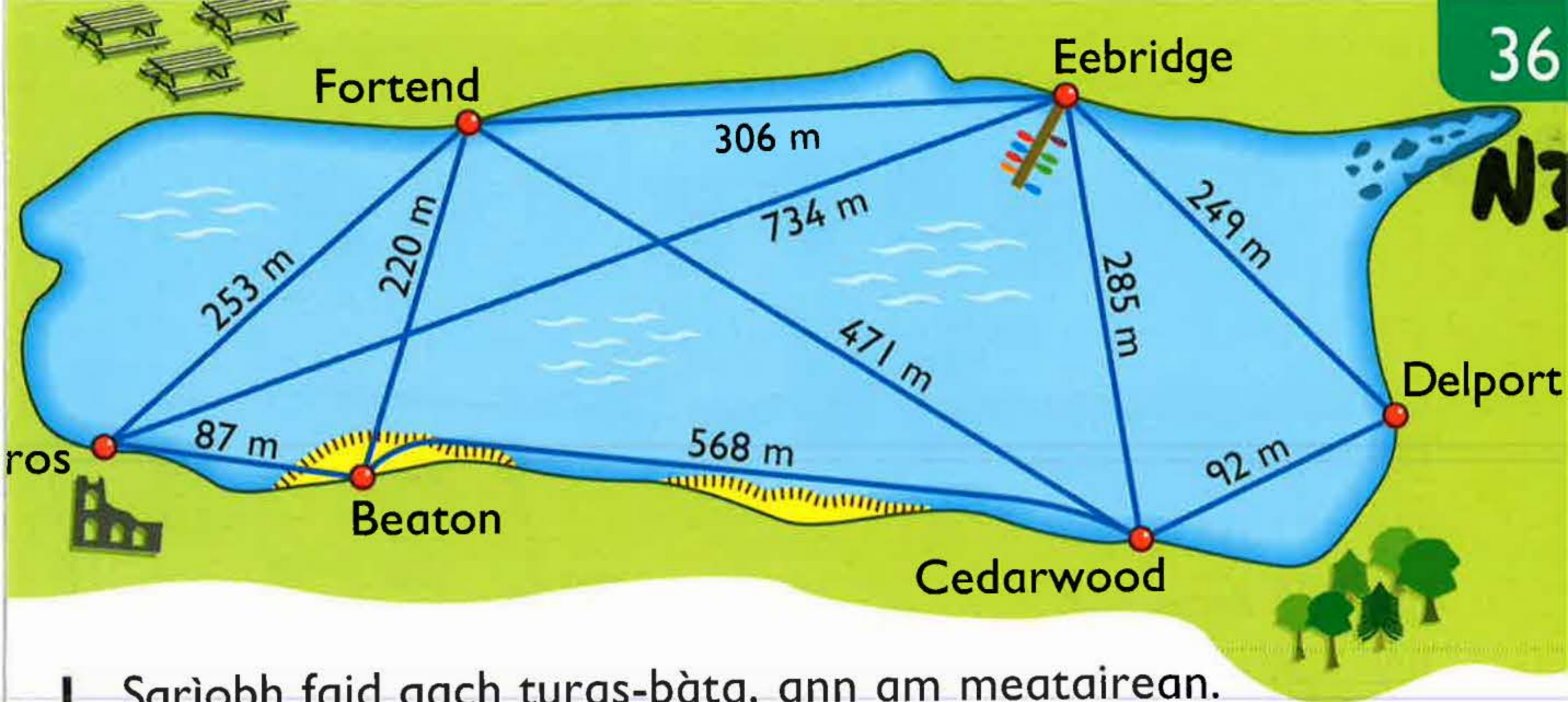

1 Sgrìobh faid gach turas-bàta, ann am meatairean.

- Cedarwood → Delpport → Eebridge
- Aros → Beaton → Cedarwood
- Aros → Fortend → Eebridge
- Beaton → Cedarwood → Eebridge
- Fortend → Beaton → Aros → Fortend
- Delpport → Eebridge → Cedarwood → Delpport

2 Dè cho fada 's a tha a' chiad turas a bharrachd air an dara turas:

- Bho Beaton gu Cedarwood agus bho Cedarwood gu Delpport
- Bho Aros gu Fortend agus bho Aros gu Beaton
- Bho Eebridge gu Aros agus bho Eebridge gu Fortend
- Bho Fortend gu Cedarwood agus bho Eebridge gu Cedarwood?

3 Dè an turas as fhaide, agus le cia mheud meatair?

- Cedarwood gu Eebridge gu Fortend no Cedarwood gu Fortend
- Fortend gu Beaton gu Aros no Fortend gu Aros

4 Dh'fhàg an *Jenny* Aros agus sheòl i gu dà àite. Tha astar 724 meatairean anns an turas gu lèir. Càit a bheil turas *Jenny* a' crìochnachadh?







1 Cleachd na figearan **3**, **5** agus **8**.

Dè an diofar eadar

(a) 583 agus 385

(b) 835 agus 538

(c) 358 agus 853?

2 Cuir na **figearan** anns gach freagairt ann an ceist 1 ri chèile. Dè tha thu a' mothachadh?

3 Dèan ceistean 1 agus 2 a-rithist airson seataichean eile de thrì figearan. Dè tha thu a' mothachadh?

4 (a) Cleachd na **figearan** **2**, **6** agus **9**.

Sgrìobh • an àireamh as motha a gheibh thu

• an àireamh as lugha a gheibh thu.

Dè an diofar a tha eadar na h-àireamhan seo?

(b) Dèan seo a-rithist, a' cleachdadh nam figearan ann am freagairt 4(a)... agus a-rithist a' cleachdadh nam figearan nad fhreagairt ùir.

5 Dèan ceist 4 a-rithist airson seataichean eile de thrì figearan. Dè tha thu a' mothachadh?

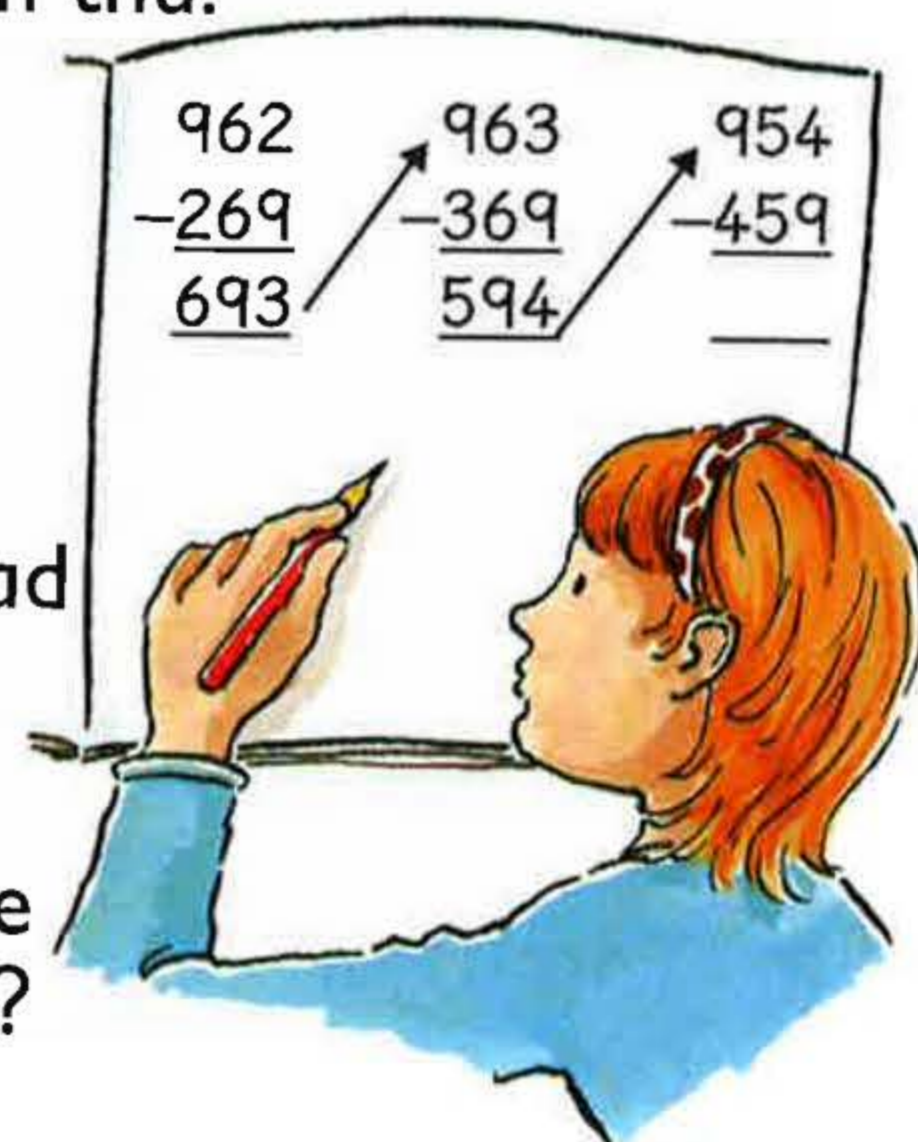
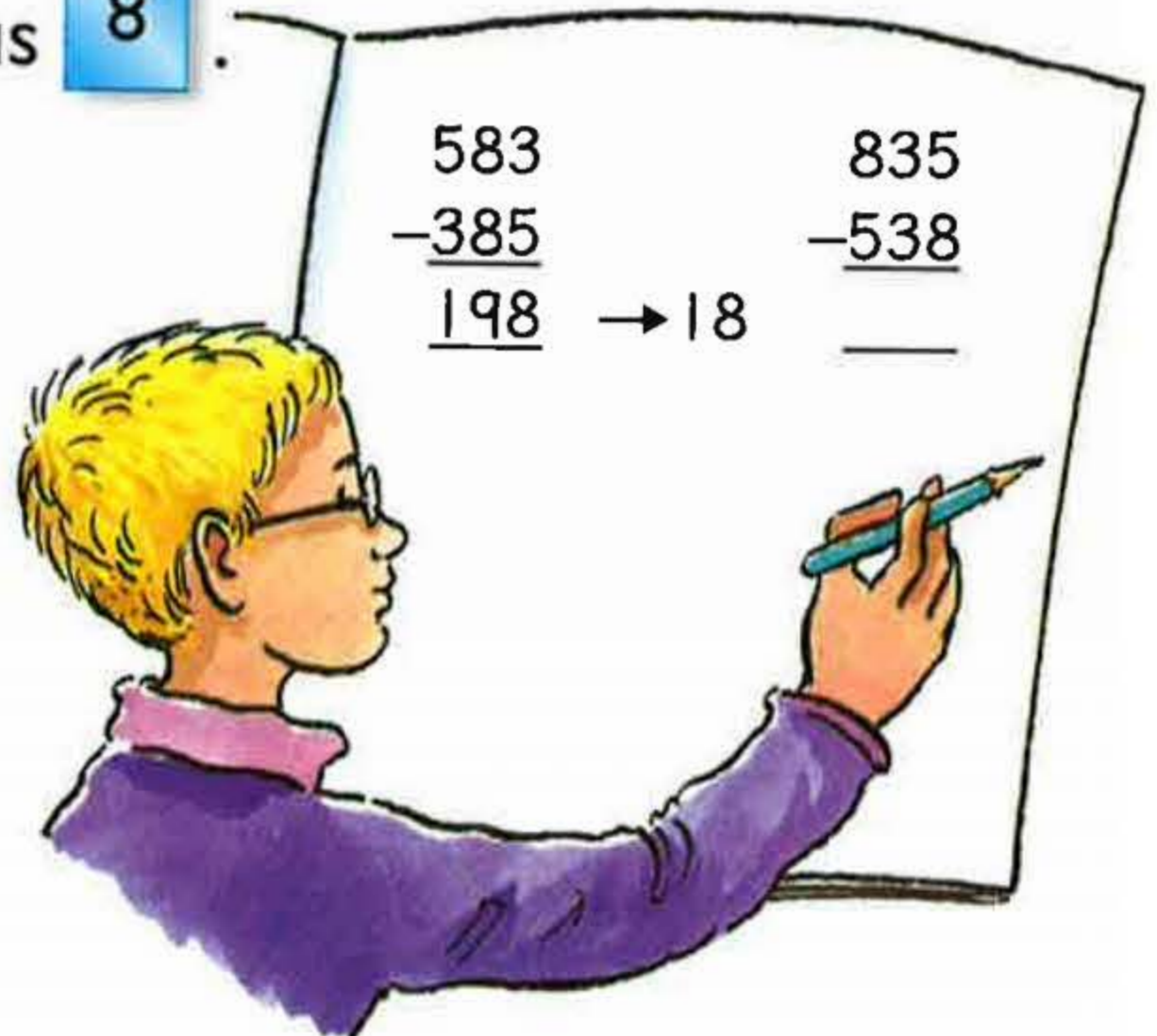













1 Cia mheud cèic a tha air:

- (a) 6 truinnean dearga (b) 7 truinnean uaine  
 (c) 4 truinnean gorma (d) 3 truinnean uaine  
 (e) 10 truinnean gorma (f) 8 truinnean dearga  
 (g) 5 truinnean gorma agus 4 uaine  
 (h) 9 truinnean uaine agus 3 dhearg?

2



Lorg prìs:

- (a) 7  (b) 6  (c) 3  (d) 8   
 (e) 2  agus 9  (f) 10  agus 5 .

3 Cheannaich Zoe 5  agus 4 .

Dè na fhuair i air ais bho 50sg?

- (a)  $2 \times 9$  (b)  $5 \times 3$  (c)  $8 \times 5$   
 (d)  $4 \times 3$  (e)  $3 \times 9$  (f)  $7 \times 2$   
 (g) 7 air iomadachadh le 10 (h) 5 air iomadachadh le 5

- 5 (a)  $2 \times \blacksquare = 16$  (b)  $4 \times \blacksquare = 0$  (c)  $6 \times \blacksquare = 30$   
 (d)  $\blacksquare \times 10 = 30$  (e)  $\blacksquare \times 4 = 28$  (f)  $\blacksquare \times 3 = 27$



1 Tha 10 briosaidean ann am poca.  
Cia mheud briosgaid a tha ann an:

- (a) 14 pocannan (b) 70 poca  
(c) 22 poca (d) 38 pocannan  
(e) 291 poca (f) 103 pocannan?



2 Tha roilichean air am bruich air treidhichean le 100.  
Cia mheud roile a tha air:

- (a) 6 treidhichean (b) 10 treidhichean  
(c) 18 treidhichean (d) 35 treidhichean  
(e) 87 treidhichean (f) 70 treidhichean?



3 Tha 10  
pàipearan-cèice  
anns gach **pacaid**.



Tha 100  
pàipearan-cèice  
anns gach **bogsa**.



Cia mheud pàipear-cèice a tha ann an:

- (a) 19 pacaidean (b) 11 bogsa (c) 54 pacaidean  
(d) 66 bogsaichean (e) 12 bogsa agus 7 pacaidean  
(f) 5 bogsaichean agus 23 pacaidean?

- 4 (a)  $10 \times \blacksquare = 190$  (b)  $\blacksquare \times 100 = 5000$   
(c)  $100 \times \blacksquare = 7800$  (d)  $\blacksquare \times 84 = 8400$   
(e)  $41 \times \blacksquare = 410$  (f)  $\blacksquare \times 136 = 1360$





1 Lorg prìs:

- (a) 8 leabhraichean mun Fhànas
- (b) 5 leabhraichean Dìneasair
- (c) 9 leabhraichean Dhìneasair
- (d) 8 leabhraichean Fealla-dhà
- (e) 8 leabhraichean Dhìneasair agus 1 leabhar mun Fhànas.

2 Tha leabhraichean air am pacadh ann am bogsaichean de 8.

Cia mheud leabhar a tha ann an:

- (a) 4 bogsaichean
- (b) 3 bogsaichean
- (c) 10 bogsaichean
- (d) 6 bogsaichean?



3

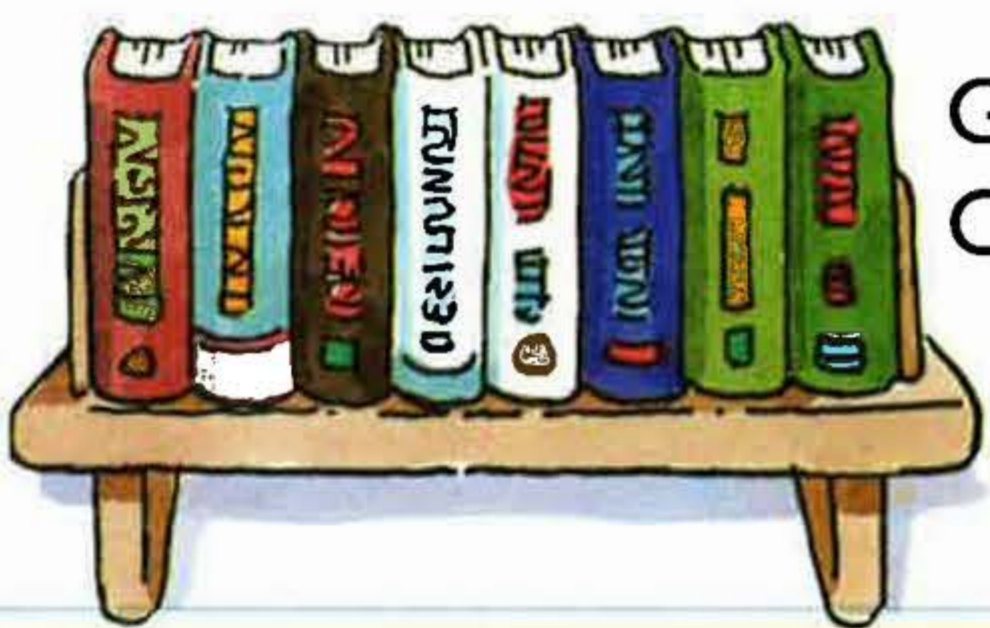

Gabhaidh gach sgeilp 8 leabhraichean. Cia mheud leabhar a tha air:

- (a) 2 sgeilp
- (b) 5 sgeilpichean
- (c) 9 sgeilpichean
- (d) 7 sgeilpichean

4 Cheannaich Siù trì ticeadan £8, agus ochd ticeadan aig £5. Dè na phàigh i gu lèir?



- 5 (a)  $8 \times \blacksquare = 48$
- (b)  $8 \times \blacksquare = 8$
- (c)  $8 \times \blacksquare = 32$
- (d)  $\blacksquare \times 8 = 0$
- (e)  $\blacksquare \times 8 = 56$
- (f)  $\blacksquare \times 8 = 80$





1 Cia mheud a tha ann an:

- (a) 6 pacaidean chreadhanan (b) 6 pacaidean pheansailean  
(c) 9 pacaidean pheann (d) 10 pacaidean pheann?

2



Lorg prìs:

- (a) 6 bileagan dearga  
(b) 3 bileagan gorma  
(c) 6 bileagan uaine  
(d) 8 bileagan gorma agus 2 uaine.

3 Tha pinn air an reic ann am pacaidean beaga anns a bheil 8, agus ann am pacaidean mòra anns a bheil 25.

- (a) Cò aige a tha as motha de phinn?  
(b) Cia mheud a bharrachd?

Tha 6 pacaidean beaga agamsa.



Julie

Tha 2 phacaid mhòr agamsa.



Dave

- 4 (a)  $6 \times \blacksquare = 36$  (b)  $6 \times \blacksquare = 0$  (c)  $6 \times \blacksquare = 54$   
(d)  $\blacksquare \times 6 = 60$  (e)  $\blacksquare \times 6 = 24$  (f)  $\blacksquare \times 6 = 6$



- 1 Tha bùth a' reic 9 irisean de *An Gàrradh* gach seachdain.  
Cia mheud a tha air an reic ann an:
- (a) 3 seachdainean (b) 7 seachdainean  
(c) 10 seachdainean (d) 9 seachdainean?

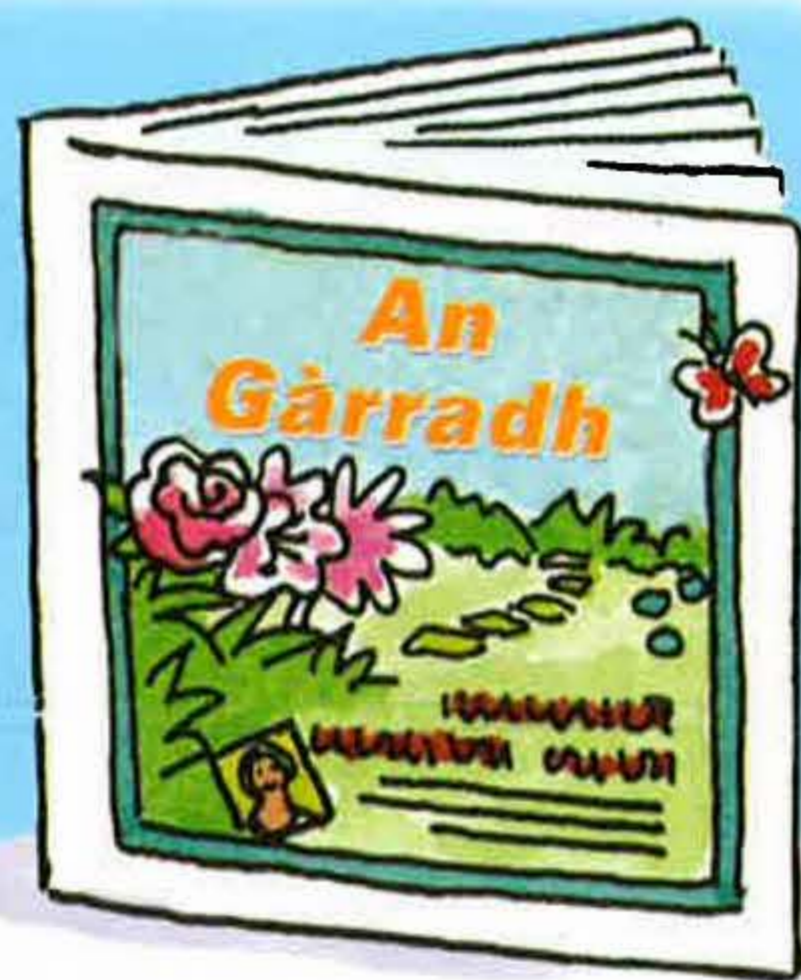

- 2 Ann an iris na seachdain-sa, tha pacaid shìol an-asgaidh.



Cia mheud sìol a tha ann an:

- (a) 9 pacaidean chularan (b) 9 pacaidean pheasairean  
(c) 4 pacaidean phònairean (d) 8 pacaidean phònairean?

3



### Co-fharpais An Gàrradh



Cleachd an còd agus lorg lus na seachdain-sa.

- (a) 9 uiread 9 (b)  $5 \times 9$   
(c)  $9 \times 7$  (d) 10 naoidhean  
(e) 6 naoidhean (f) 9 uiread 2

54 → S	63 → D
45 → A	81 → R
72 → P	18 → H
90 → I	36 → C

- 4 (a)  $9 \times \blacksquare = 36$  (b)  $9 \times \blacksquare = 9$  (c)  $9 \times \blacksquare = 63$   
(d)  $\blacksquare \times 9 = 72$  (e)  $\blacksquare \times 9 = 27$  (f)  $\blacksquare \times 9 = 81$



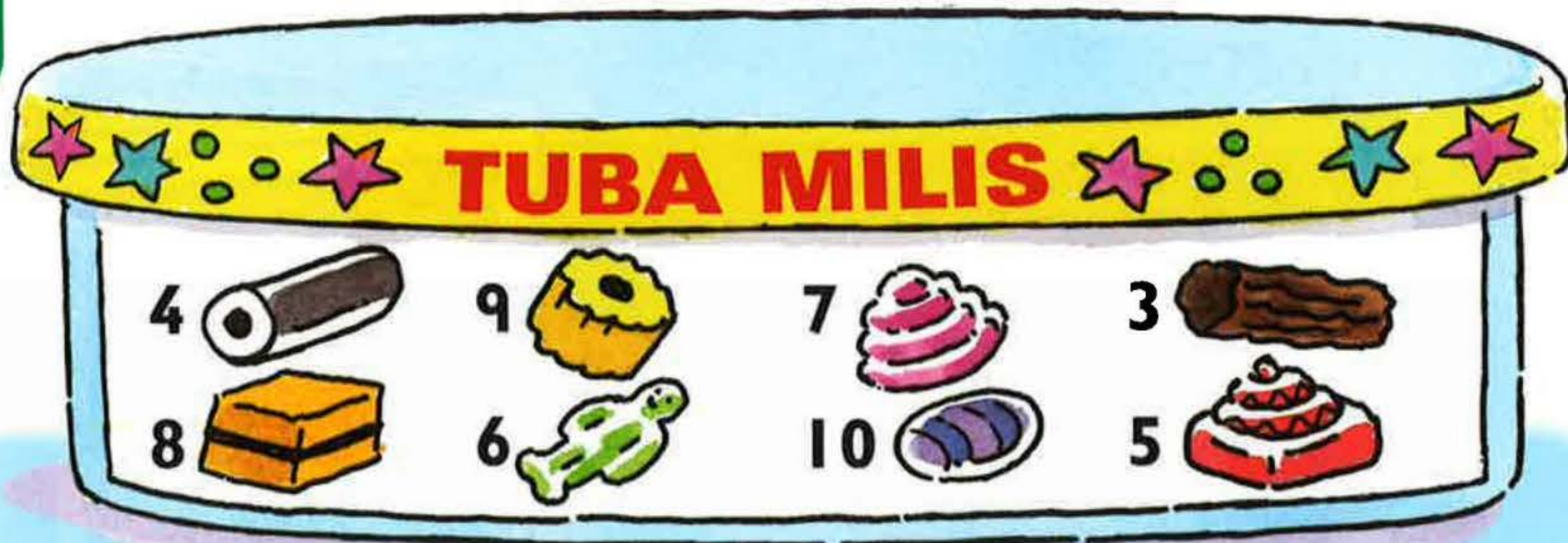

1 Cia mhead a tha ann an **seachd** Tubaichean?



- 2 (a)  $7 \times 2$  (b)  $9 \times 7$  (c)  $7 \times 0$  (d)  $10 \times 7$   
 (e)  $5 \times 7$  (f)  $7 \times 1$  (g)  $4 \times 7$  (h)  $8 \times 7$

3



Lorg prìs:

- (a) 7 tubaichean beaga (b) 9 tubaichean mòra  
 (c) 7 tubaichean meadhanach

4 Cia mhead **stigear** a tha a' tighinn an-asgaidh còmhla ri:

- (a) 7 tubaichean mòra (b) 8 tubaichean meadhanach  
 (c) 7 tubaichean beaga?

- 5 (a)  $7 \times \blacksquare = 49$  (b)  $7 \times \blacksquare = 42$  (c)  $7 \times \blacksquare = 70$   
 (d)  $\blacksquare \times 7 = 21$  (e)  $\blacksquare \times 7 = 0$  (f)  $\blacksquare \times 7 = 14$   
 (g)  $7 \times \blacksquare = 63$  (h)  $\blacksquare \times 7 = 7$  (i)  $7 \times \blacksquare = 35$



1 Freagair na ceistean air cairtean nan cracaran.

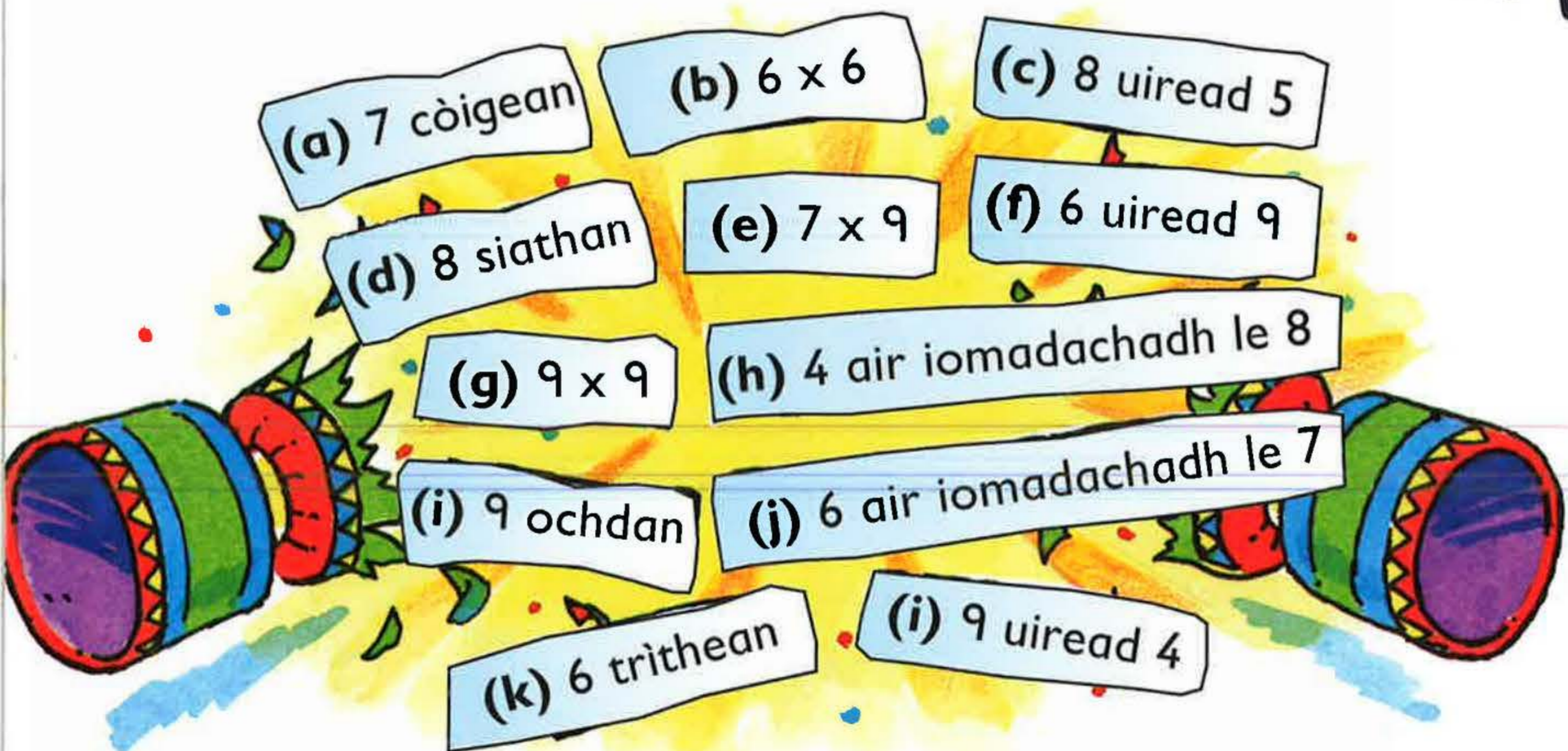

2 Cia mheud cracar a tha ann an:

- |                          |                           |
|--------------------------|---------------------------|
| (a) 6 bogsaichean dearga | (b) 4 bogsaichean uaine   |
| (c) 5 bogsaichean pinc   | (d) 7 bogsaichean uaine   |
| (e) 3 bogsaichean gorma  | (f) 10 bogsaichean dearga |
| (g) 9 bogsaichean uaine  | (h) 8 bogsaichean gorma   |
| (i) 10 bogsaichean pinc  | (j) 5 bogsaichean dearga  |

3

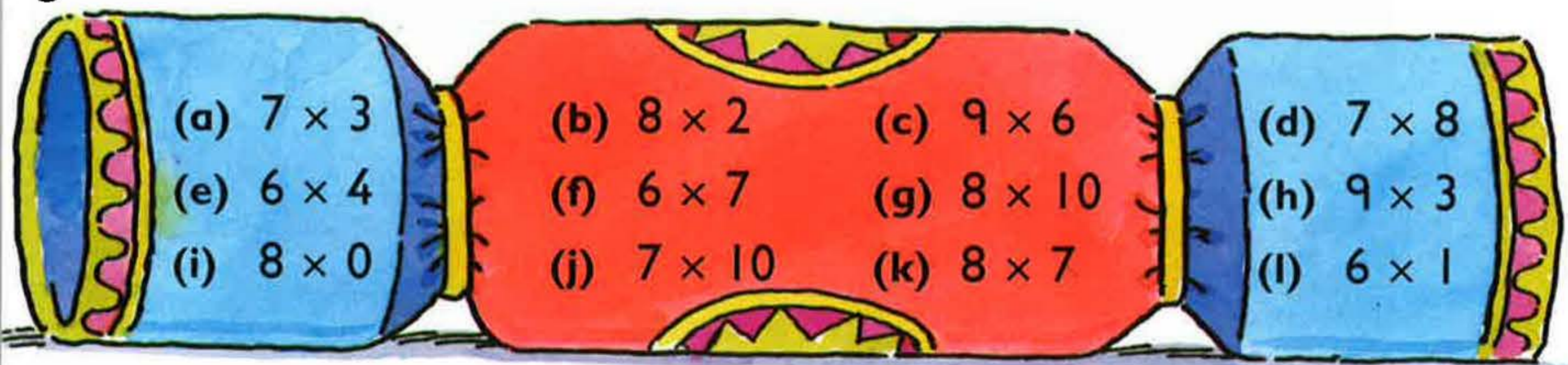

- 4 (a)  $9 \times \blacksquare = 18$       (b)  $8 \times \blacksquare = 72$       (c)  $6 \times \blacksquare = 48$   
 (d)  $\blacksquare \times 7 = 0$       (e)  $\blacksquare \times 1 = 9$       (f)  $\blacksquare \times 7 = 49$



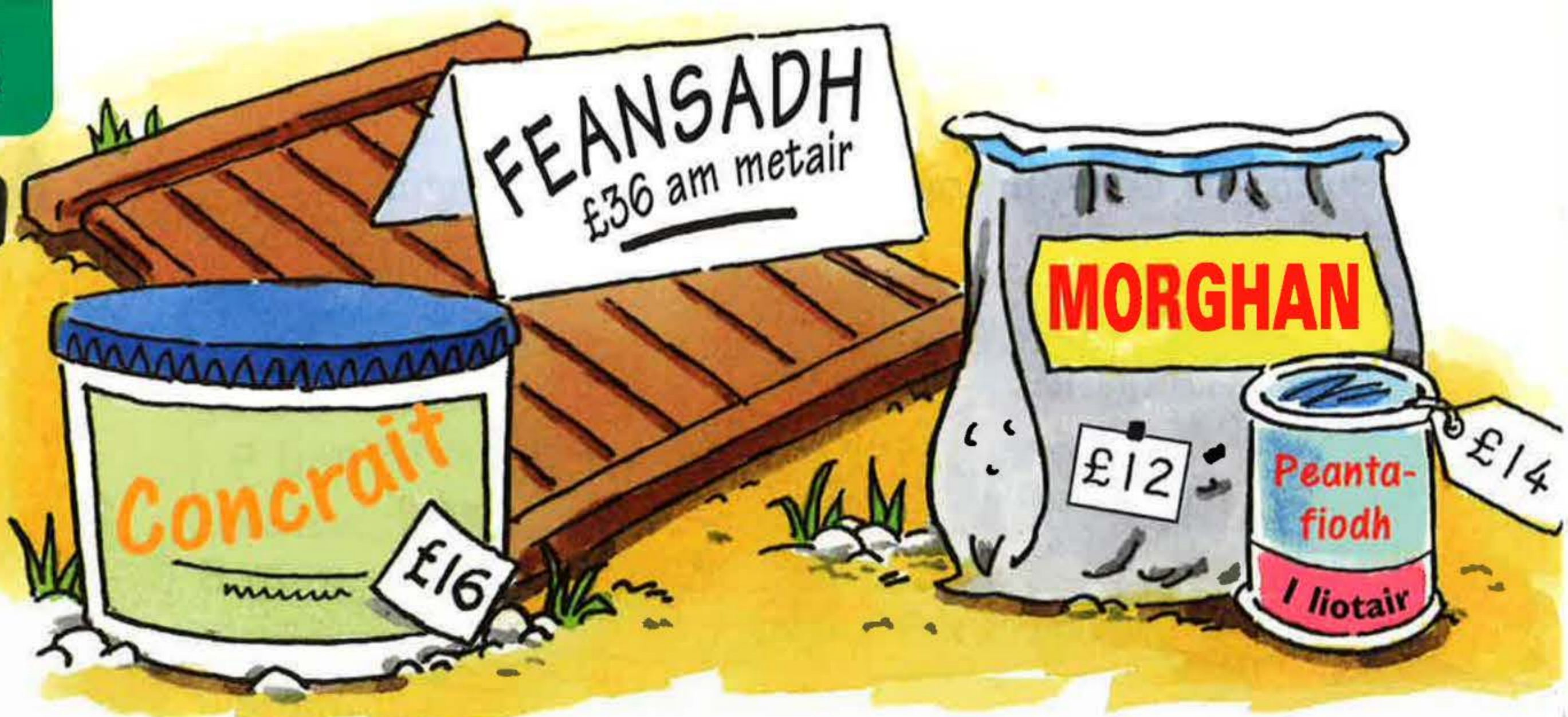

1 Lorg prìs gach rud air liosta Mhgr Stiùbhart.

### Stuth a' Ghàrraidh

- (a) 3 meatairean de dh'fheansadh
- (b) 4 liotairean de pheanta-fiodh
- (c) 5 tubaichean de choncraic
- (d) 20 poca morghain

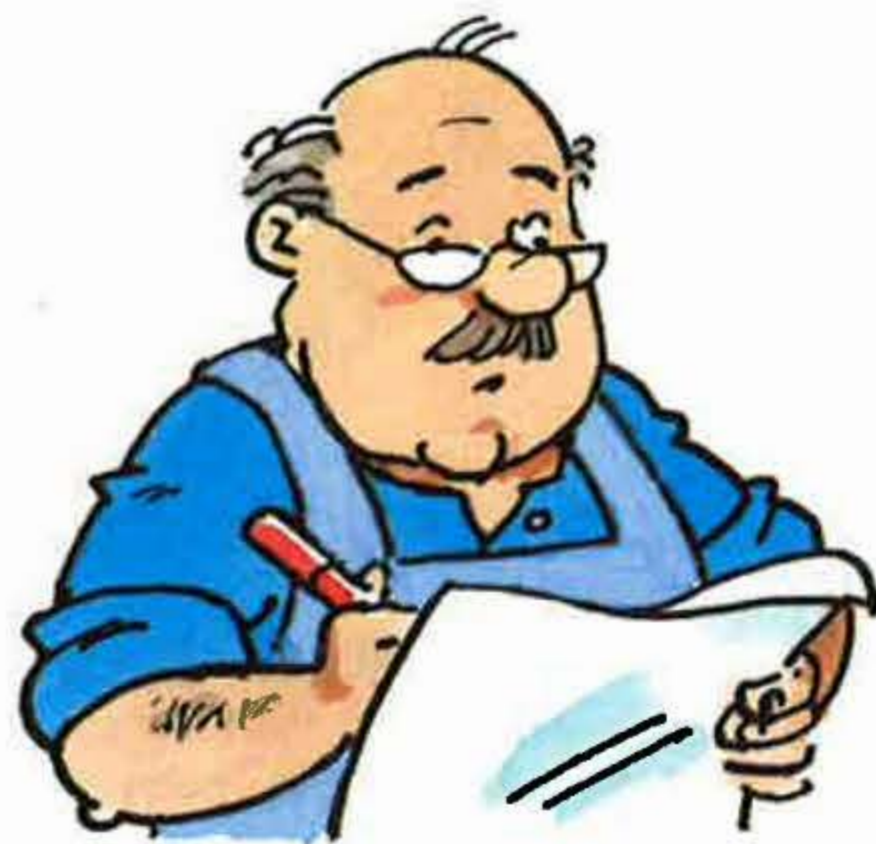

- 2
- |                   |                   |                   |                   |
|-------------------|-------------------|-------------------|-------------------|
| (a) $4 \times 18$ | (b) $3 \times 26$ | (c) $5 \times 12$ | (d) $2 \times 39$ |
| (e) $3 \times 37$ | (f) $4 \times 25$ | (g) $5 \times 19$ | (h) $4 \times 40$ |
| (i) $5 \times 17$ | (j) $4 \times 30$ | (k) $5 \times 28$ | (l) $4 \times 23$ |
| (m) $2 \times 47$ | (n) $5 \times 15$ | (o) $3 \times 29$ | (p) $5 \times 26$ |

3

(a)  $20 \times 16$

(b)  $20 \times 33$

(c)  $20 \times 19$

(d)  $20 \times 20$

(e)  $20 \times 45$

(f)  $20 \times 50$

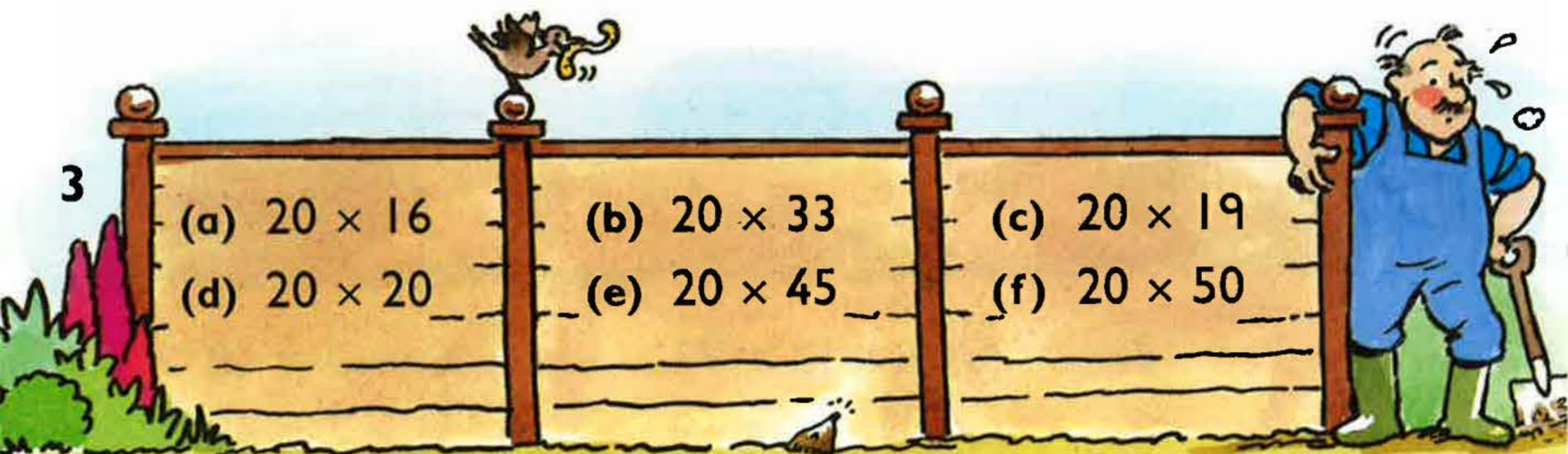





Cia mheud cairt a tha ann an

- |                        |                      |
|------------------------|----------------------|
| (a) 2 phacaid Cartùn   | (b) 5 pacaidean Pop  |
| (c) 3 pacaidean Spòrs  | (d) 2 phacaid Film   |
| (e) 5 pacaidean Cartùn | (f) 4 pacaidean Film |
| (g) 4 pacaidean Pop    | (h) 5 pacaidean Film |
| (i) 5 pacaidean Spòrs  |                      |

- |                                   |                                   |                                   |                   |
|-----------------------------------|-----------------------------------|-----------------------------------|-------------------|
| (a) $3 \times 60$                 | (b) $4 \times 50$                 | (c) $5 \times 70$                 | (d) $4 \times 90$ |
| (e) $2 \times 80$                 | (f) $3 \times 90$                 | (g) $4 \times 40$                 | (h) $5 \times 50$ |
| (i) $2 \times \blacksquare = 100$ | (j) $3 \times \blacksquare = 210$ | (k) $4 \times \blacksquare = 320$ |                   |



3 Lorg **tuairmse** air na prìsean seo:

- |              |                   |                             |
|--------------|-------------------|-----------------------------|
| (a) 5 CDan   | (b) 4 geamannan   | (c) 3 meuran-clàr           |
| (d) 2 gheama | (e) 5 meuran-clàr | (f) 3 bogsaichean pheantan. |



Dèan tuairmse.  
A bheil airgead gu leòr aig Ben airson 5 seataichean bhidiothan a cheannach? Mìnich.



14

Ath-sgrìobh agus crìochnaich. Feuch an lorg thu **dà** fhreagairt airson gach tè.

(a)  $\blacksquare \times \blacktriangle = 42$

(b)  $\blacksquare \times \blacktriangle = 63$

(c)  $\blacksquare \times \blacktriangle = 72$

(d)  $\blacksquare \times \blacktriangle = 54$

(e)  $\blacksquare \times \blacktriangle = 56$

(f)  $\blacksquare \times \blacktriangle = 48$

2 Sgrìobh **paidhir** de dh'àireamhan aig a bheil:

(a) suim 11, agus toradh 24

(b) suim 13, agus toradh 36

(c) suim 14, agus toradh 49

(d) diofar 3, agus toradh 70

(e) diofar 0, agus toradh 64.



3 Lorg **diofar dhòighean** gus gach iomadachadh a chrìochnachadh.

(a)  $\blacksquare \blacktriangle \times \blacklozenge = 80$

(b)  $\blacksquare \blacktriangle \times \blacklozenge = 120$

4 Lorg an àireamh leis an do **thòisich** gach leanabh.



(a)

Chuir mi 5 ris, agus dh'iomadaich mi le 10. Fhuair mi 630.



(b)

Thug mi air falbh 2 agus dh'iomadaich mi le 100. 'S e 3400 am freagairt agam.

(c)

Chuir mi 4 ris an àireamh agus dh'iomadaich mi le 3. Fhuair mi 90.

(d)

Thug mi air falbh 3 agus dh'iomadaich mi le 4. 'S e 88 am freagairt agam.







1 Cia mheud teanta a dh'fheumas tu airson:

- (a) 14 cubs le 2 anns gach teanta    (b) 20 cub le 4 anns gach teanta  
 (c) 45 cubs le 5 anns gach teanta    (d) 12 cub le 3 anns gach teanta  
 (e) 60 cub le 10 anns gach teanta    (f) 30 cub le 3 anns gach teanta?

2 Roinn iad seo gu cothromach eadar na teantaichean.

- (a) 5 cubs ann an 5 teantaichean    (b) 28 cubs ann an 4 teantaichean  
 (c) 24 cubs ann an 3 teantaichean    (d) 30 cub ann an 10 teantaichean  
 (e) 8 cubs ann an 4 teantaichean    (f) 25 cubs ann an 5 teantaichean

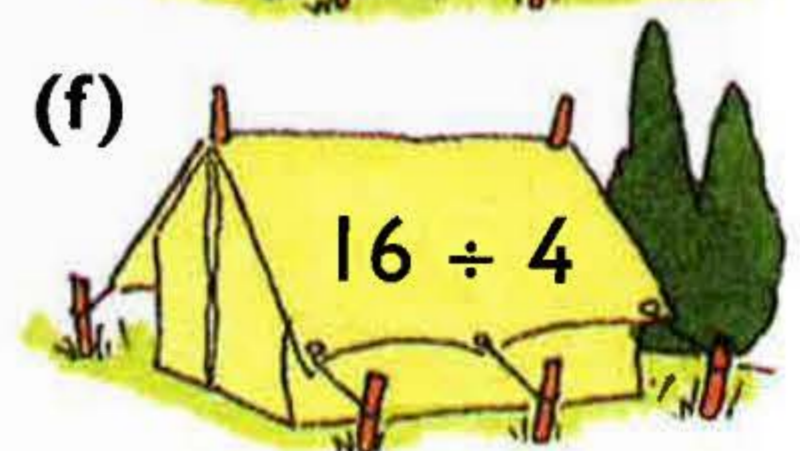
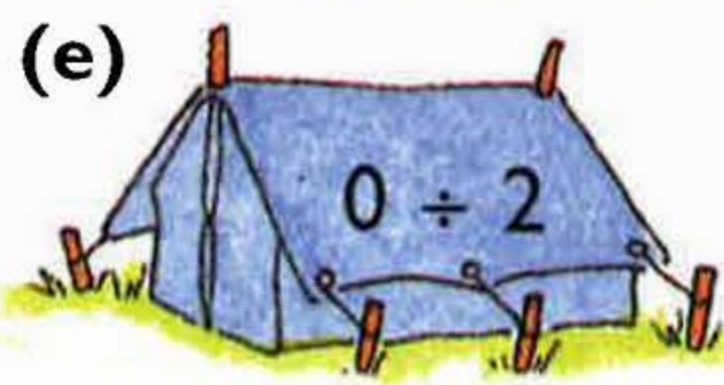
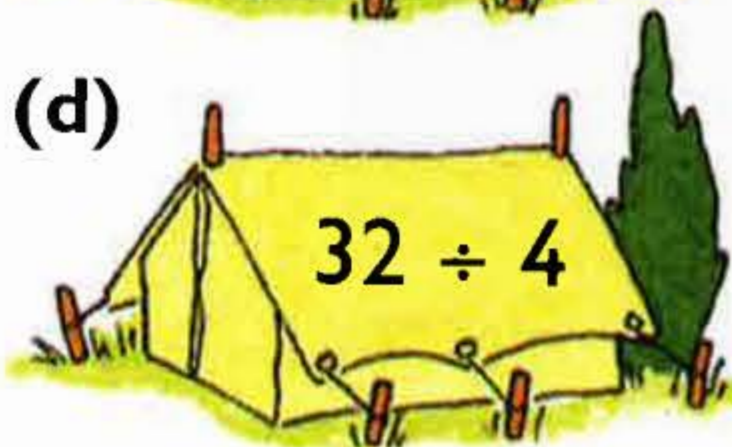
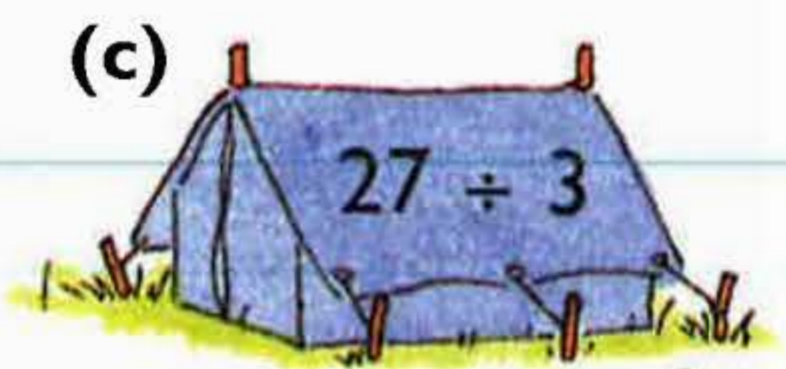
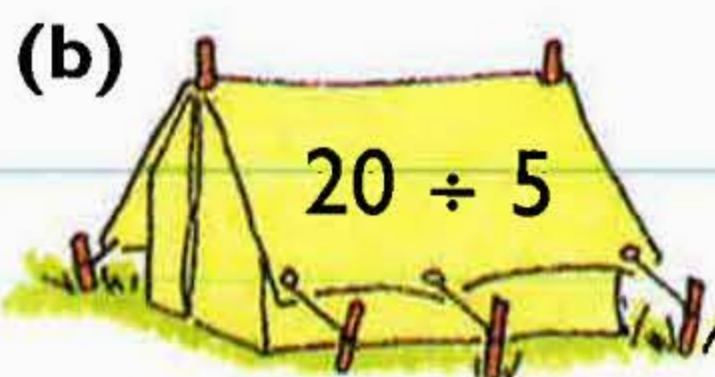
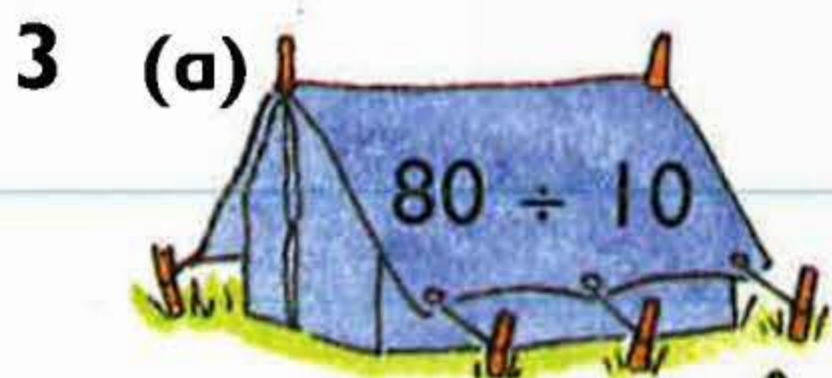

4 (a)  $\blacksquare \div 3 = 6$

(b)  $\blacksquare \div 2 = 9$

(c)  $\blacksquare \div 5 = 4$

(d)  $40 \div \blacksquare = 10$

(e)  $70 \div \blacksquare = 7$

(f)  $15 \div \blacksquare = 5$





1 Roinn iad seo gu cothromach eadar na cubs.

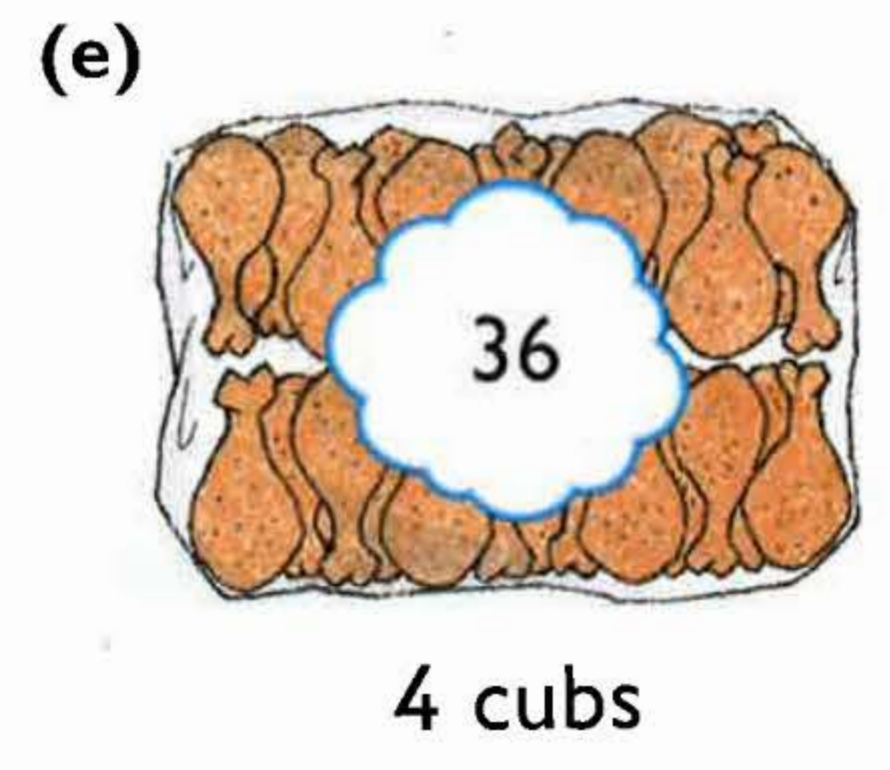
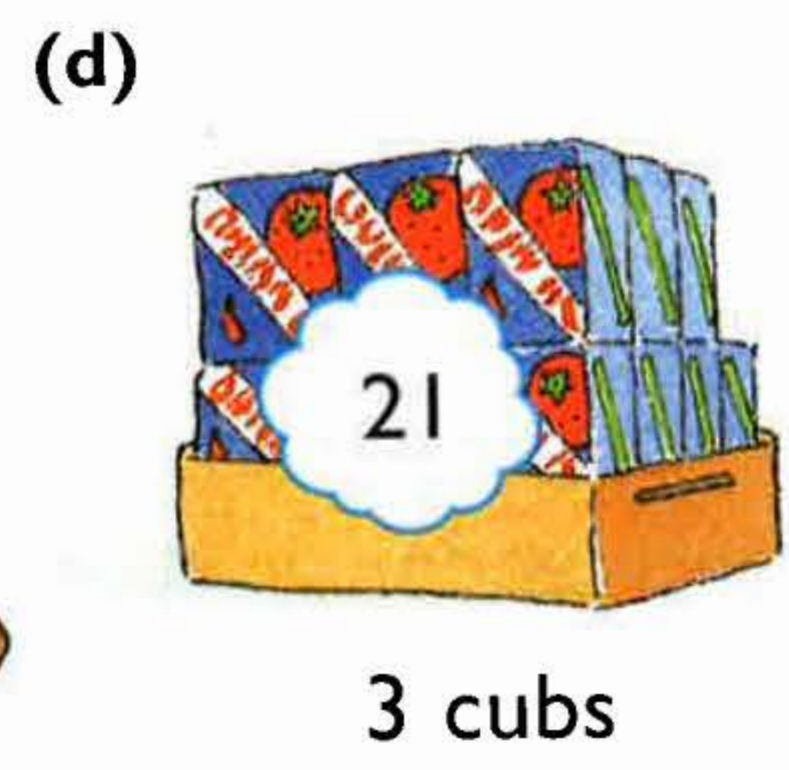
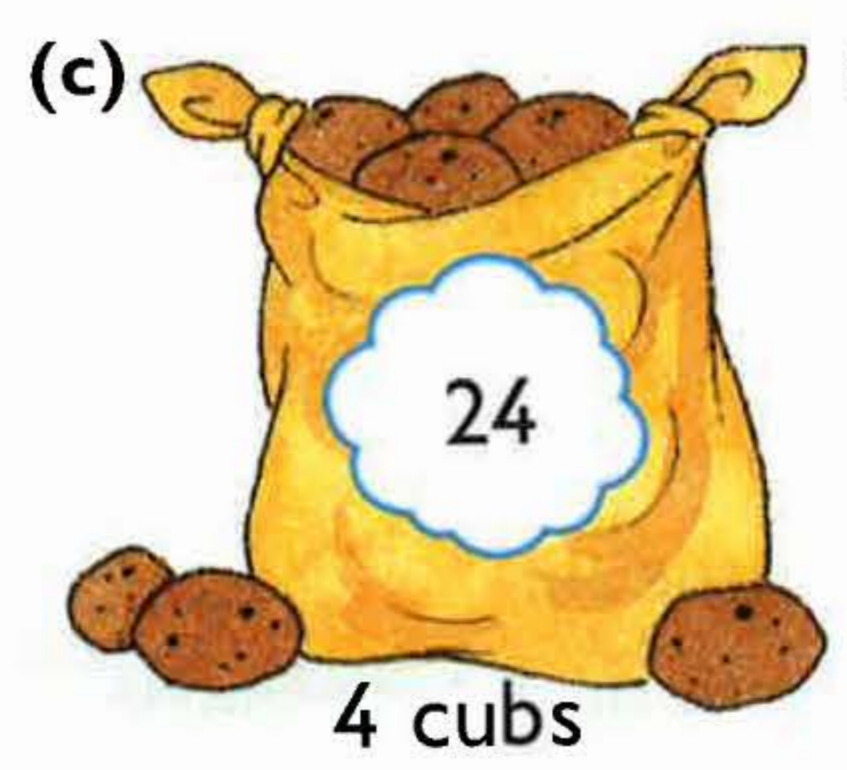
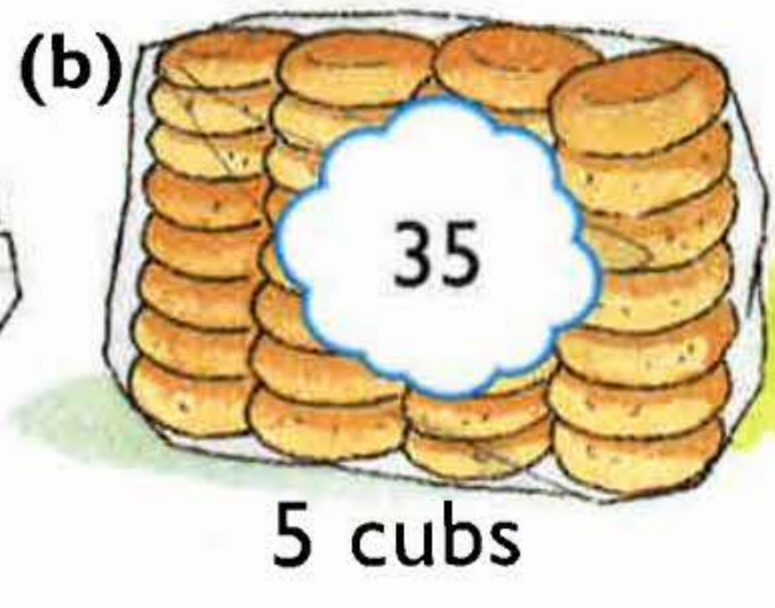
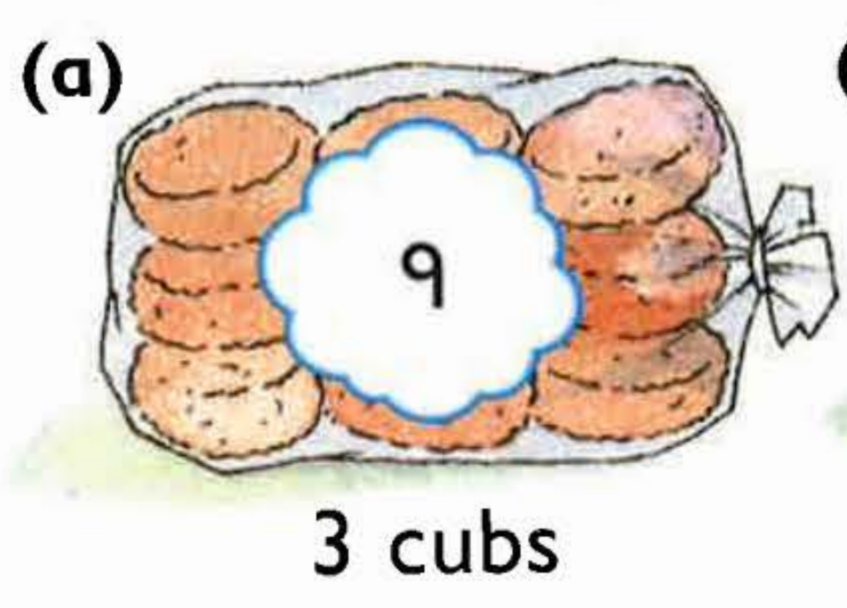

2 (a) Roinn 100 le 10.

(b) Cia mheud buidheann de 5 a tha ann an 15?

(c) Neoni air a roinn le 4.

(d) Roinn 12 gu cothromach eadar 3

(e) Leth de 16

(f) Cia mheud còig a tha ann an 30

(g) Roinn 40 le 10.

(h) Cairteal de 4

3 (a)  $\blacksquare \div 3 = 2$

(b)  $\blacksquare \div 10 = 9$

(c)  $\blacksquare \div 2 = 5$

(d)  $50 \div \blacksquare = 10$

(e)  $32 \div \blacksquare = 8$

(f)  $27 \div \blacksquare = 9$

4 Tha eadar 20 agus 50 bratach ann.

Gheibh iad air an roinn gu cothromach eadar 2 theanta no 4 teantaichean no 5 teantaichean.

Cia mheud bratach a tha ann?





1 Gheibh 8 chloinne air suidhe anns gach loga.

Cia mheud loga a dh'fheumas iad airson:

- |                |                |
|----------------|----------------|
| (a) 40 leanabh | (b) 56 leanabh |
| (c) 16 leanabh | (d) 48 leanabh |
| (e) 24 leanabh | (f) 72 leanabh |

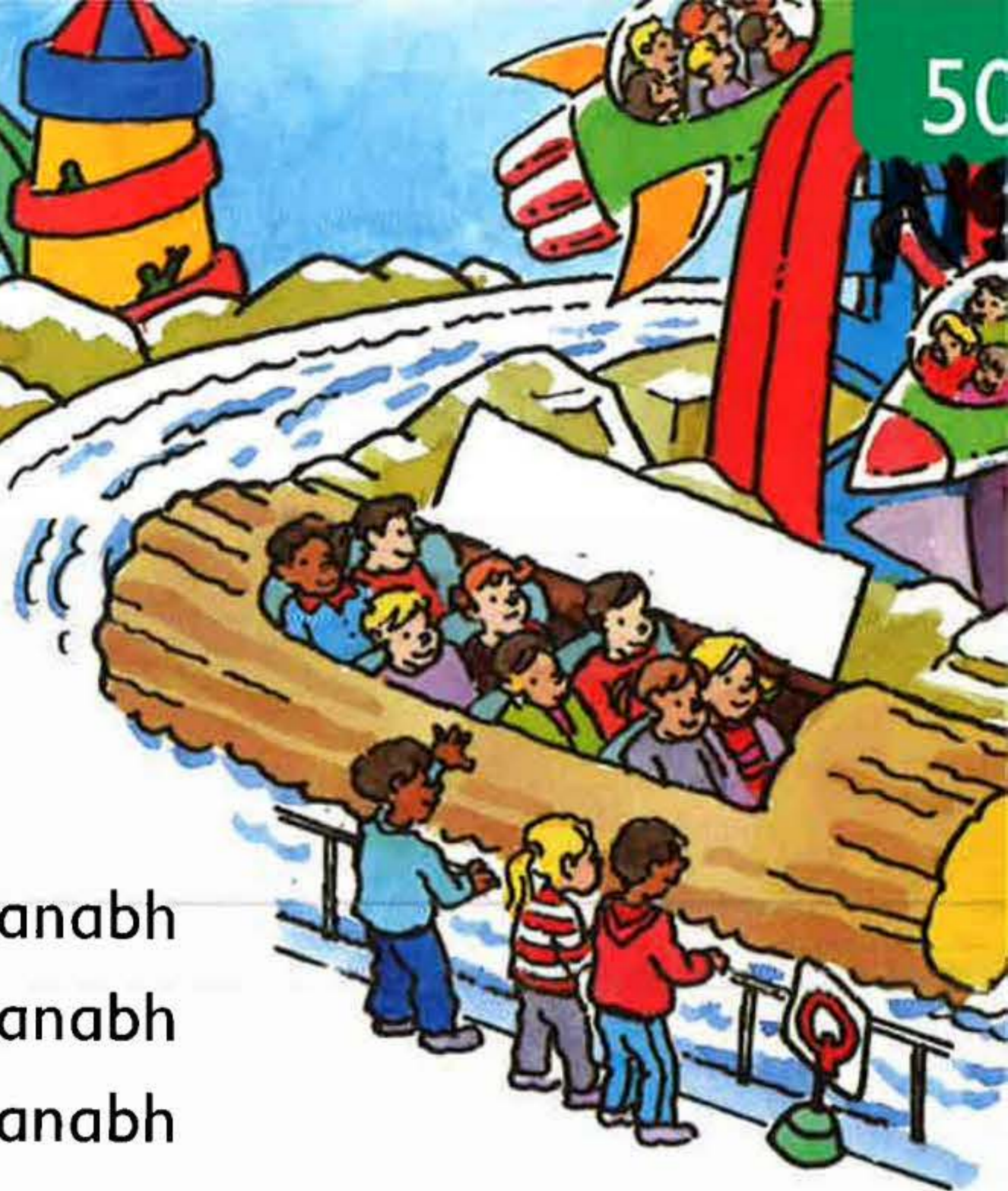

- 2
- |                         |   |
|-------------------------|---|
| (a) Roinn 64 le 8.      | (b) Cia mheud ochd a tha ann an 56?       |
| (c) 16 air a roinn le 8 | (d) Roinn 32 gu cothromach eadar 8.       |
| (e) Roinn 80 le 8.      | (f) 8 air a roinn gu cothromach eadar 8   |
| (g) 48 air a roinn le 8 | (h) Cuir 24 ann am buidhnean de dh'ochdan |

- 3
- |                                |                               |                                |
|--------------------------------|-------------------------------|--------------------------------|
| (a) $72 \div 8 = \blacksquare$ | (b) $8 \div 8 = \blacksquare$ | (c) $0 \div 8 = \blacksquare$  |
| (d) $\blacksquare \div 8 = 8$  | (e) $\blacksquare \div 8 = 4$ | (f) $\blacksquare \div 8 = 10$ |

- 2
- (a) Chosg Jem £40 air lèintean-T. Cia mheud a cheannaich i?
- (b) Chosg Sàra £64 air leabhraichean agus tubhailtean. Cheannaich i trì **uiread** de leabhraichean na cheannaich i de thubhailtean.

Cia mheud a cheannaich i de gach rud?





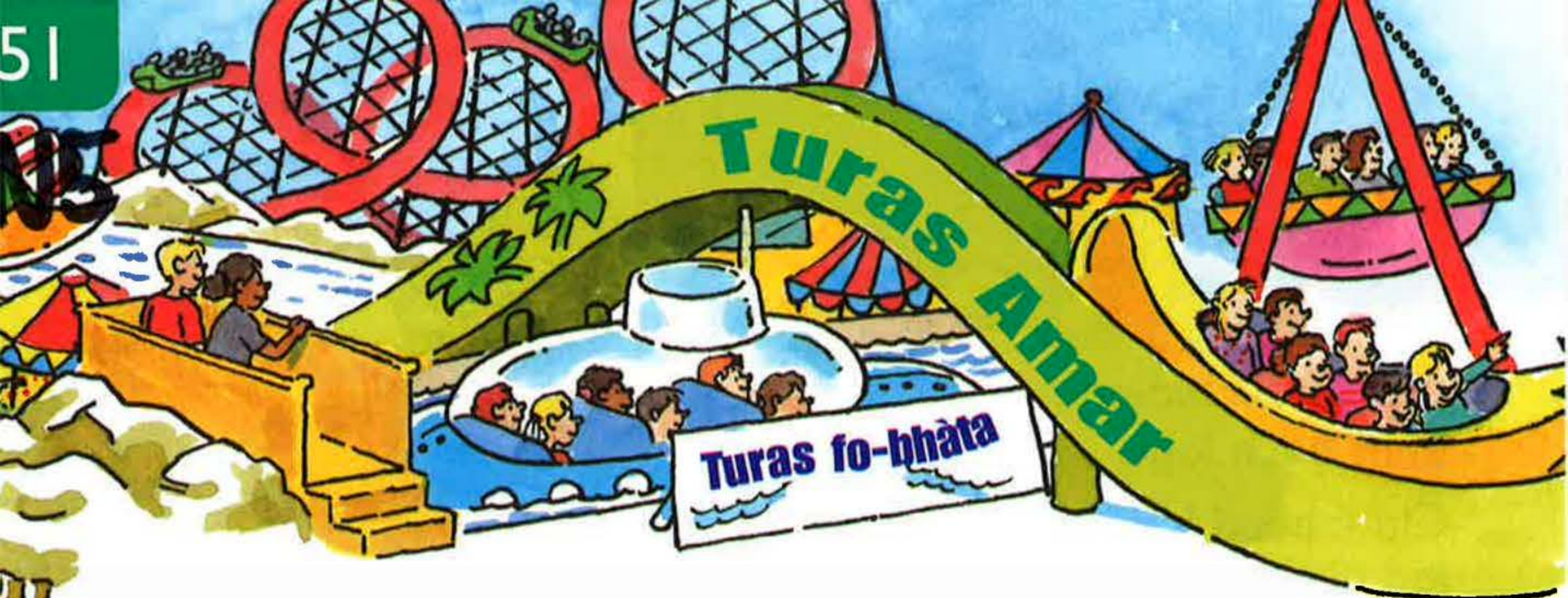

1 Tha am fo-bhàta a' gabhail sianar chloinne gach turas.  
Cia mheud turas a dh'fheumadh tu airson:

- (a) 18 leanabh      (b) 42 leanabh      (c) 60 leanabh



- (d) 30 leanabh      (e) 54 leanabh      (f) 12 leanabh?



- 2 (a) 6 air a roinn le 6      (b) Cia mheud sia a tha ann an 36?  
(c) Roinn 24 le 6.      (d) Roinn 12 gu cothromach eadar 6.  
(e) Roinn 36 le 6.      (f) Cia mheud buidheann de 6 a  
tha ann an 48?  
(g) 0 air a roinn le 6      (h) Roinn 60 gu cothromach eadar 6.

3  Cia mheud bhidio a gheibh thu air:

- (a) £30      (b) £54      (c) £42?

- 4 (a)  $48 \div 6 = \blacksquare$       (b)  $6 \div 6 = \blacksquare$       (c)  $24 \div 6 = \blacksquare$   
(d)  $\blacksquare \div 6 = 3$       (e)  $\blacksquare \div 6 = 10$       (f)  $\blacksquare \div 6 = 0$





1 Feumaidh gach cluicheadair 9 cairtean Snap.  
Cia mheud leanabh a dh'fhaodas cluich le:

(a) (b) (c) (d) (e) (f)

- 2 (a) 81 air a roinn le 9. (b) 9 air a roinn gu cothromach am measg 9  
(c) Roinn 27 le 9. (d) Cia mheud buidheann de 9 a tha ann an 90?  
(e) Roinn 0 le 9. (f) Cia mheud naoi a tha ann an 45?  
(g) 36 air a roinn le 9 (h) Roinn 72 gu cothromach eadar 9.

3 Cia mheud dìsne a gheibh thu air ceannach ma chosgas tu:

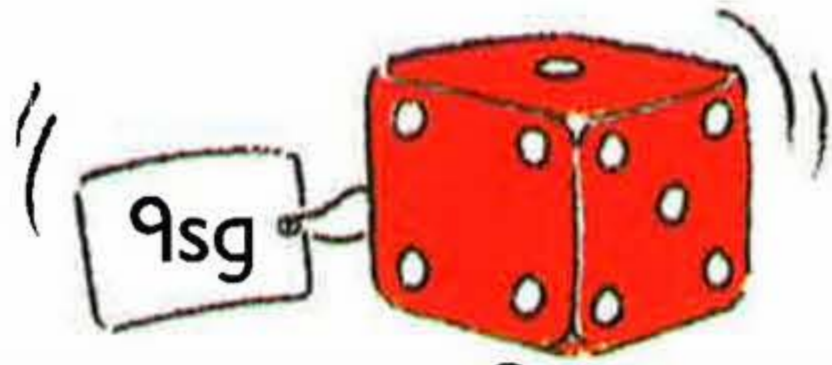

- (a) 18sg (b) 63sg (c) 54sg (d) 81sg?

- 4 (a)  $9 \div 9 = \blacksquare$  (b)  $90 \div 9 = \blacksquare$  (c)  $27 \div 9 = \blacksquare$   
(d)  $\blacksquare \div 9 = 5$  (e)  $\blacksquare \div 9 = 8$  (f)  $\blacksquare \div 9 = 0$





1 Bheir a' chairt 7 chloinne air gach turas.  
Cia mheud turas a dh'fheumar airson:

- (a) 21 leanabh                      (b) 56 leanabh  
(c) 35 leanabh                      (d) 70 leanabh  
(e) 42 leanabh                      (f) 63 leanabh?

- 2 (a) Roinn 28 le 7.                      (b) Roinn 49 gu cothromach eadar 7.  
(c) 7 air a roinn le 7                      (d) Cia mheud seachd a bheir dhut 14?  
(e) Roinn 35 le 7.                      (f) Cia mheud buidheann de 7 a tha ann an 63?  
(g) 0 air a roinn le 7                      (h) Roinn 21 gu cothromach eadar 7.

- 3 (a)  $42 \div 7 = \blacksquare$                       (b)  $56 \div 7 = \blacksquare$                       (c)  $0 \div 7 = \blacksquare$   
(d)  $\blacksquare \div 7 = 4$                       (e)  $\blacksquare \div 7 = 7$                       (f)  $\blacksquare \div 7 = 1$

4 Tha ticeadan airson an turais air a' chairt a' cosg  
7sg am fear. Cia mheud ticead  
a gheibh thu ma chosgas tu:

- (a) 14sg                      (b) 70sg                      (c) 35sg  
(d) 63sg                      (e) 21sg                      (f) 56sg?

5 Cheannaich Màiri dhà uimhir a  
thiceadan ri Àdhamh airson an turais.  
Chosg na ticeadan aca còmhla 63sg.  
Cia mheud ticead a cheannaich iad  
an duine?

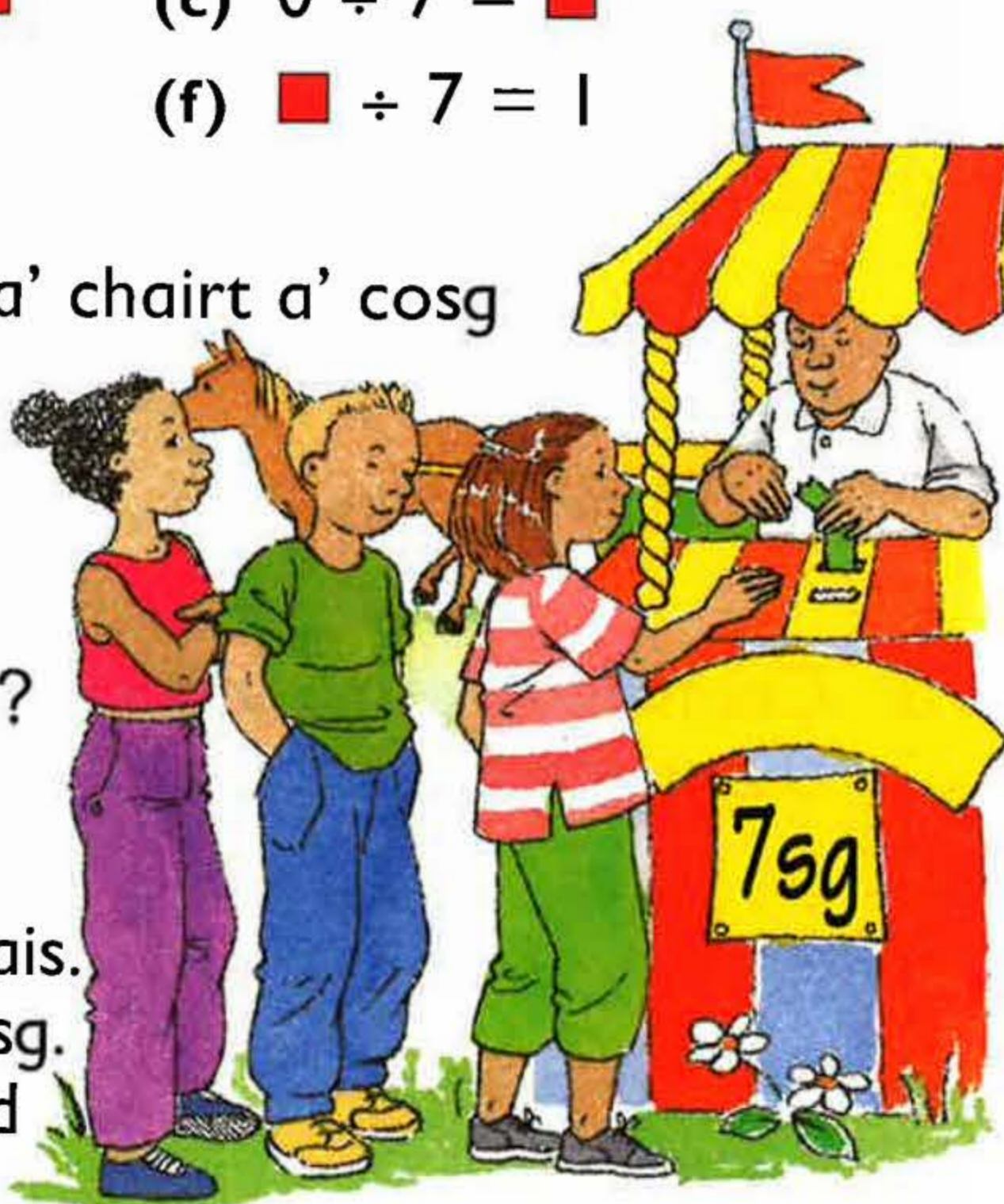



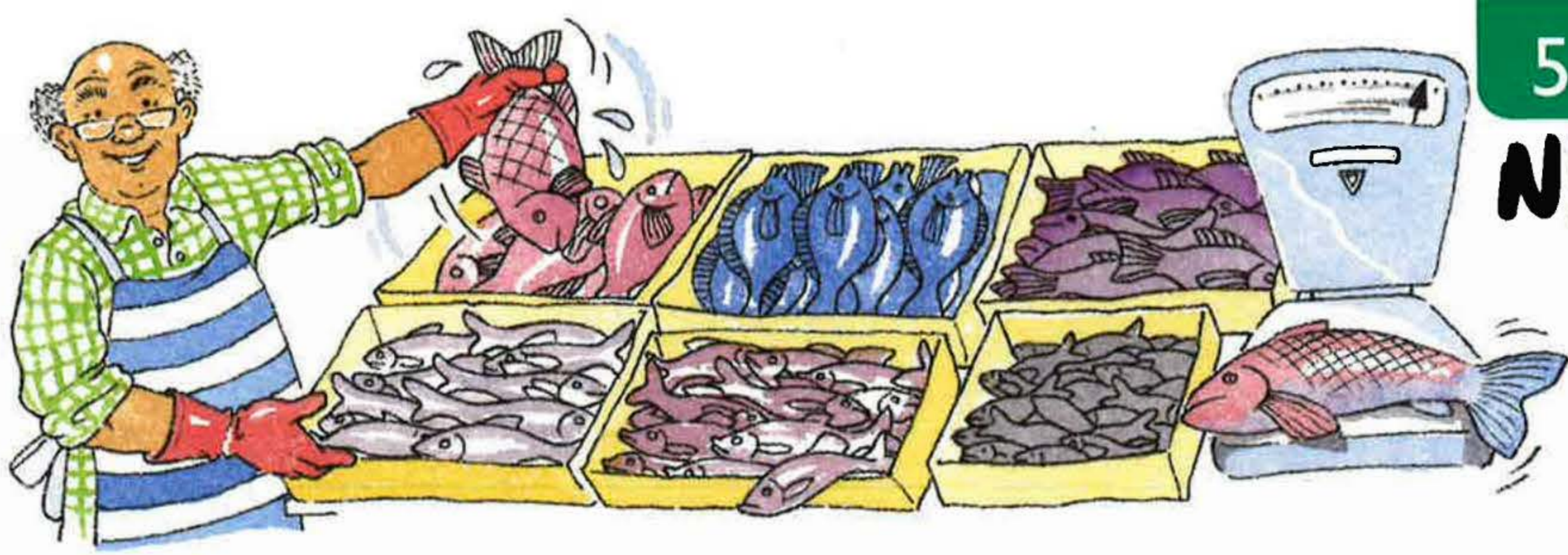

1 Roinn iad seo gu cothromach eadar na treidhichean.

(a) 60 sàrdain → 6 treidhichean (b) 21 breac → 7 treidhichean

(c) 54 truisg → 9 treidhichean (b) 70 sgadan → 7 treidhichean

(e) 12 adag → 6 treidhichean (b) 45 bradain → 9 treidhichean

(g) 49 leòbagan → 7 treidhichean (b) 72 cudaig → 9 treidhichean

2 (a) Roinn 9 le 9. (b) 48 air a roinn gu cothromach eadar 6

(c) 28 air a roinn le 7 (d) Cia mheud còig a tha ann an 45?

(e) Roinn 0 le 8. (f) Cia mheud buidheann de 6 a tha ann an 1

(g) 63 air a roinn le 7 (h) Roinn 16 gu cothromach eadar 2.

3 (a)  $63 \div 9 = \blacksquare$  (b)  $6 \div 6 = \blacksquare$  (c)  $0 \div 7 = \blacksquare$

(d)  $\blacksquare \div 6 = 9$  (e)  $\blacksquare \div 7 = 8$  (f)  $\blacksquare \div 9 = 0$

(g)  $30 \div \blacksquare = 5$  (h)  $32 \div \blacksquare = 8$  (i)  $81 \div \blacksquare = 9$

4 Cia mheud sàrdain a gheibh thu air:

(a) 40sg. (b) 80sg.

(c) 32sg. (d) 48sg.

5 Cheannaich Marc leth uimhir a shàrdainean 's a cheannaich Emma.

Chosg na cheannaich an dithis còmhla 72sg.

Cia mheud sàrdain a cheannaich iad an duine?







Ath-sgrìobh agus crìochnaich iad seo.

(a)  $6 \times 7 = 42$   
 $7 \times 6 = \blacksquare$   
 $42 \div 7 = \blacksquare$   
 $42 \div 6 = \blacksquare$

(b)  $8 \times 9 = 72$   
 $9 \times 8 = \blacksquare$   
 $72 \div 9 = \blacksquare$   
 $72 \div 8 = \blacksquare$

(c)  $7 \times 5 = 35$   
 $5 \times 7 = \blacksquare$   
 $35 \div \blacksquare = 7$   
 $35 \div \blacksquare = 5$

(d)  $9 \times 5 = 45$   
 $5 \times 9 = \blacksquare$   
 $45 \div \blacksquare = 9$   
 $45 \div \blacktriangle = \blacksquare$

(e)  $2 \times 80 = 160$   
 $80 \times \blacksquare = 160$   
 $160 \div \blacksquare = 2$   
 $\blacktriangle \div \blacksquare = 80$

(f)  $7 \times 100 = 700$   
 $100 \times \blacksquare = 700$   
 $700 \div \blacksquare = 7$   
 $\blacktriangle \div \blacksquare = 100$

2 Cleachd am fiosrachadh-iomadachaidh agus sgrìobh dà sgeulachd roinnidh.

(a)  $7 \times 8 = 56$

(b)  $9 \times 6 = 54$

(c)  $6 \times 4 = 24$

(d)  $2 \times 25 = 50$

(e)  $12 \times 8 = 96$

(f)  $14 \times 6 = 84$

3 Cleachd am fiosrachadh-roinnidh.

Sgrìobh dà sgeulachd iomadachaidh agus sgeulachd roinnidh eile.

(a)  $63 \div 9 = 7$

(b)  $48 \div 6 = 8$

(c)  $35 \div 7 = 5$

(d)  $32 \div 8 = 4$

(e)  $200 \div 2 = 100$

(f)  $93 \div 3 = 31$

4 Sgrìobh ceithir sgeulachdan àireamh gach turas.

(a)  $2$   $34$   $68$  (b)  $10$   $7$   $70$  (c)  $9$   $100$   $900$



1 Tha na cairtean seo air an roinn gu cothromach eadar trì sgeilpichean. Cia mheud cairt a tha a' dol air gach sgeilp, agus cia mheud a tha an còrr?

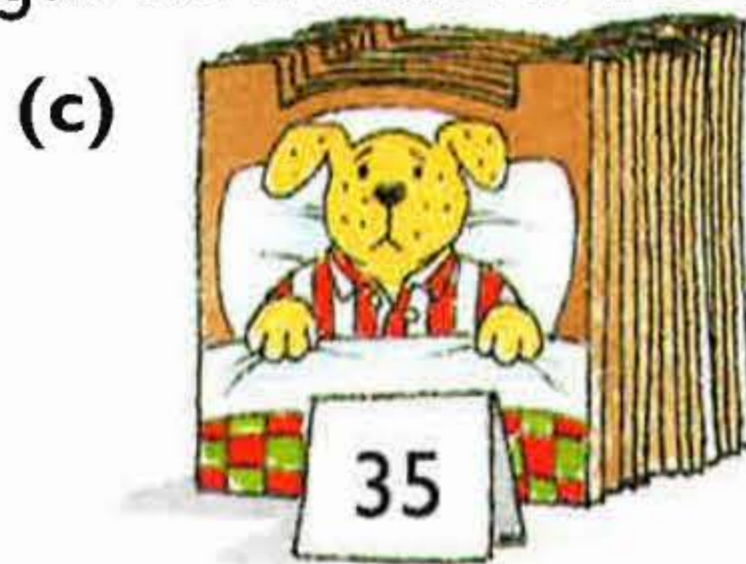
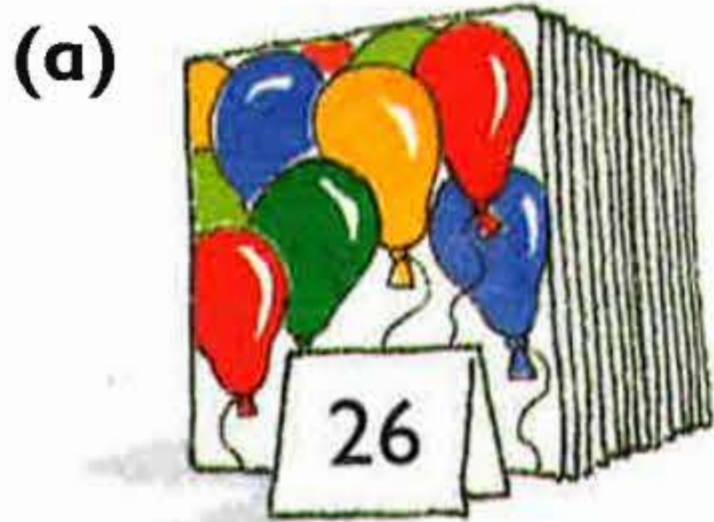

2 Tha na cairtean seo air an roinn gu cothromach eadar ceithir sgeilpichean. Cia mheud cairt a tha a' dol air gach sgeilp, agus cia mheud a tha an còrr?

- (a) 34 cairtean      (b) 31 cairt      (c) 25 cairtean?

3 Cia mheud bogsa a lìonadh tu le na cairtean seo? Cia mheud cairt a tha an còrr?

	(a)	(b)	(c)	(d)	(e)
Àireamh chairtean	17	38	46	77	60
Àireamh chairtean anns gach bogsa	2	6	5	8	7



4 Cia mheud cairt a gheibh thu air a cheannach? Dè na tha agad de dh'airgead air fhàgail?

	(a)	(b)	(c)	(d)	(e)	(f)
Tha seo agad...	47sg	19sg	37sg	54sg	75sg	95sg
Tha cairt a' cosg...	6sg	2sg	7sg	5sg	8sg	9sg

5 Lorg na h-àireamhan a tha a dhìth.

- (a)  $32 = (6 \times 5) + \blacksquare$       (b)  $45 = (7 \times 6) + \blacksquare$   
 (c)  $39 = (4 \times 9) + \blacksquare$       (d)  $39 = (5 \times 7) + \blacksquare$   
 (e)  $85 = (10 \times 8) + \blacksquare$       (f)  $438 = (100 \times 4) + \blacksquare$   
 (g)  $(18 \div \blacksquare) + 2 = 8$       (h)  $(54 \div \blacksquare) - 3 = 6$   
 (i)  $(\blacksquare \div 8) + 4 = 9$



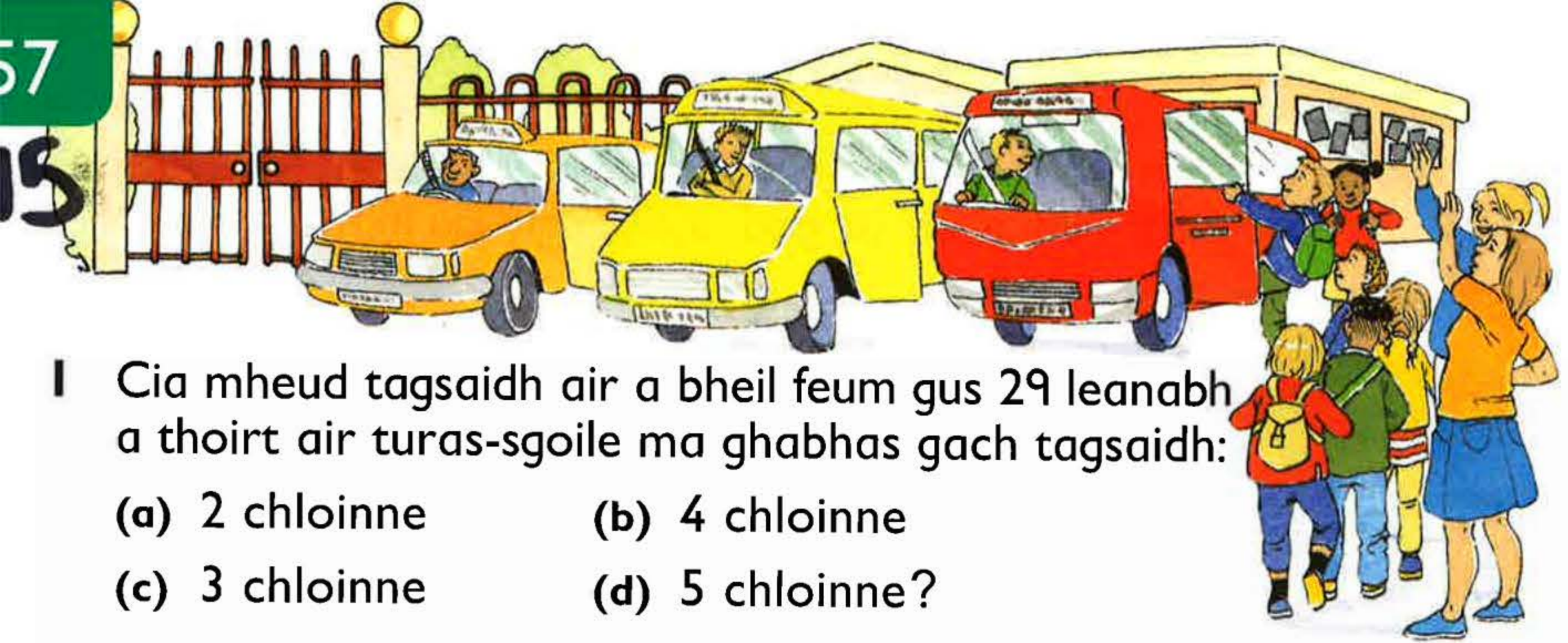

- 1 Cia mheud tagsaidh air a bheil feum gus 29 leanabh a thoirt air turas-sgoile ma ghabhas gach tagsaidh:
- (a) 2 chloinne                      (b) 4 chloinne  
 (c) 3 chloinne                      (d) 5 chloinne?

2 Cia mheud sgioba a nì thu?

	Clas 2	Clas 3	Clas 4	Clas 5	Clas 6
Àireamh chloinne	26	23	34	26	36
Àireamh ann an sgioba	3	4	10	4	5

3 Cia mheud buidheann a nì thu?  
 Cia mheud leanabh a tha ann an còrr?

	(a)	(b)	(c)	(d)	(e)	(f)
Àireamh chloinne	49	58	63	52	65	38
Àireamh ann am buidheann	6	8	7	9	10	8

4 Tha an tagsaidh le 4 chloinne a' cosg £15. Dè a tha e a' cosg airson gach leanabh?



5 Lorg na chosgas e airson gach leanabh anns na busaichean beaga seo.

(a)



Còignear  
Airson £11.

(b)



Deichnear  
Airson £17.



- 1 (a) Roinn gach treidhe de chruthan gu cothromach eadar 10 dhaoine.

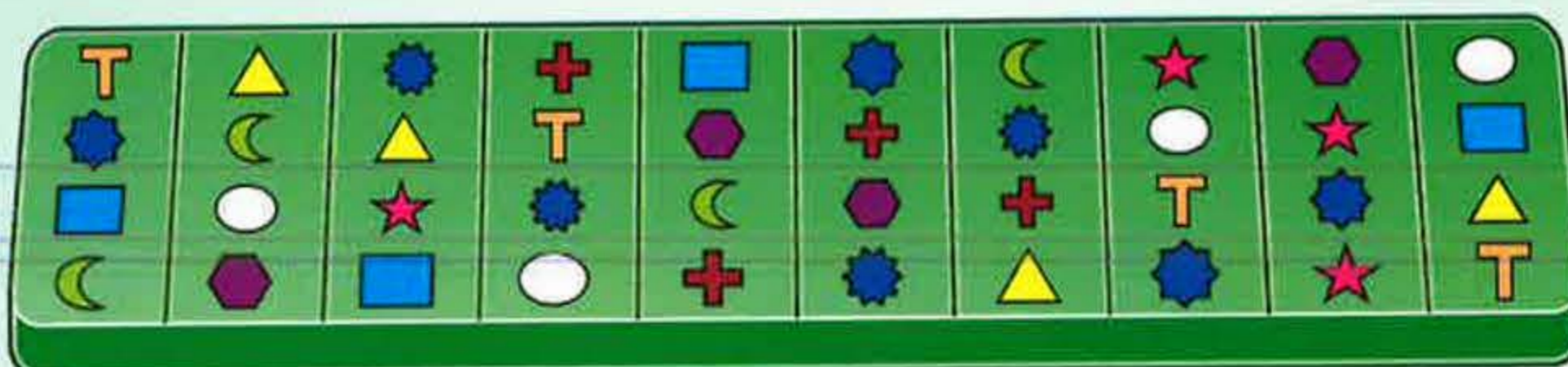
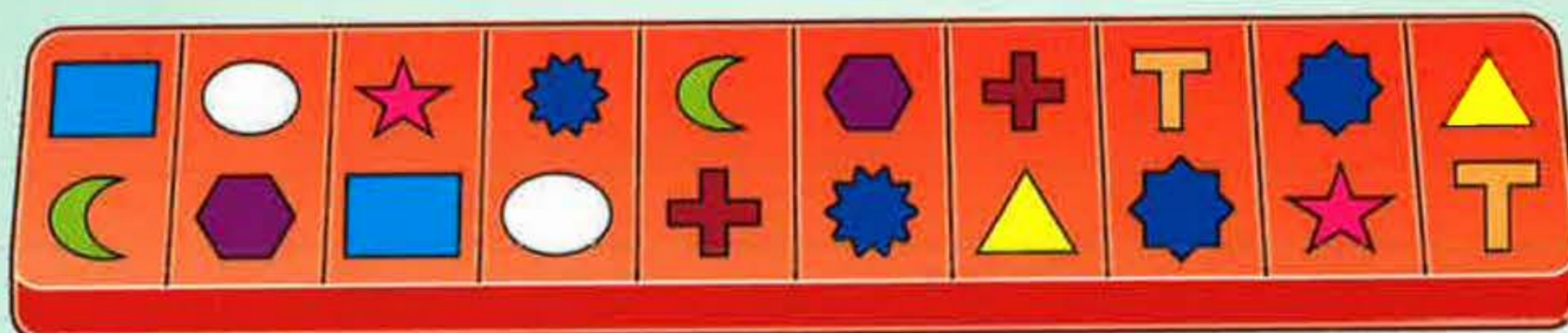

- (b) Lorg deicheamh de na cruthan a tha air gach treidhe.  
 (c) Dè tha thu a' mothachadh nuair a:

roinneas tu le 10

agus

lorgas tu deicheamh?

- 2 (a) deicheamh de 100      (b)  $\frac{1}{10}$  de 30      (c) deicheamh de 90  
 (d)  $\frac{1}{10}$  de 10      (e) deicheamh de 50      (f)  $\frac{1}{10}$  de 70

- 3 Dè a' bhloigh den phàtran air a' bhogsa a tha:

(a) dearg      (b) buidhe      (c) gun dath?

- 4 Tha 60 cruth anns a' bhogsa.

'S e ciùban a tha ann an deicheamh dhiubh.

Cia mheud cruth a tha ann **nach eil** na chiùb?





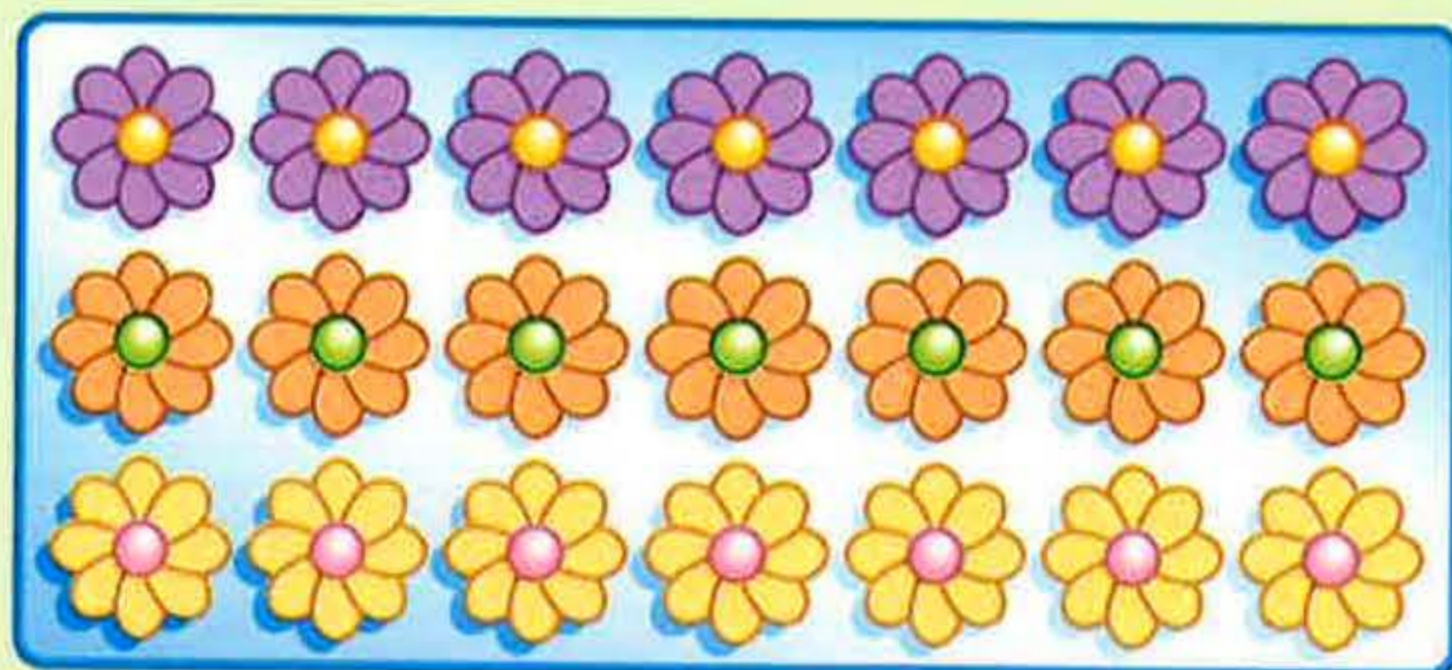
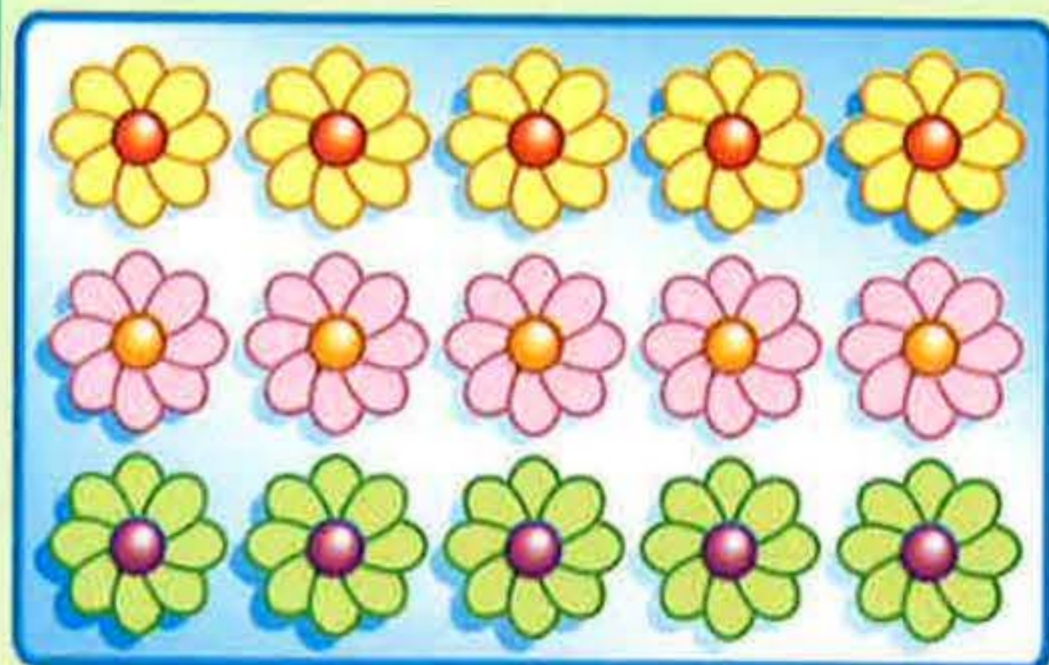

1 (a)  $\frac{1}{3}$  de 15

(b) treas de 21

2 (a)  $\frac{1}{3}$  de 27

(b) treas de 3

(c)  $\frac{1}{3}$  de 30

(d) treas de 12

(e)  $\frac{1}{3}$  de 24

(f)  $\frac{1}{3}$  de 6

3 (a) Tog tùr a' cleachdadh 9 ciùban.

Dèan treas den tùr dearg, agus dà threas den tùr buidhe.

(b) **Cia mheud** ciùb a tha: • dearg • buidhe?



4 (a) Cuir a-mach 18 ciùban.

Dèan treas de na ciùban uaine, agus treas dhiubh gorm.

(b) **Cia mheud** ciùb: • a tha gorm • nach eil gorm?



5



Tha dà threas de na ciùban agam donn.  
Tha na 5 ciùban eile geal.

Cia mheud ciùb a tha aig Sam gu lèir?

Sam



1 (a) Roinn gach treidhe de mheasan gu cothromach eadar 5 dhaoine.

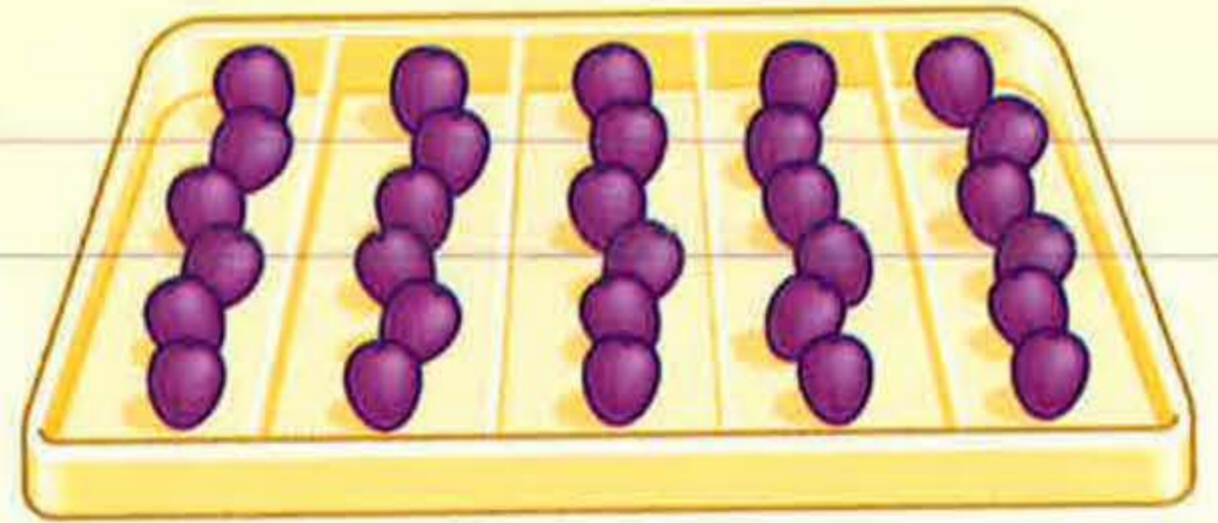
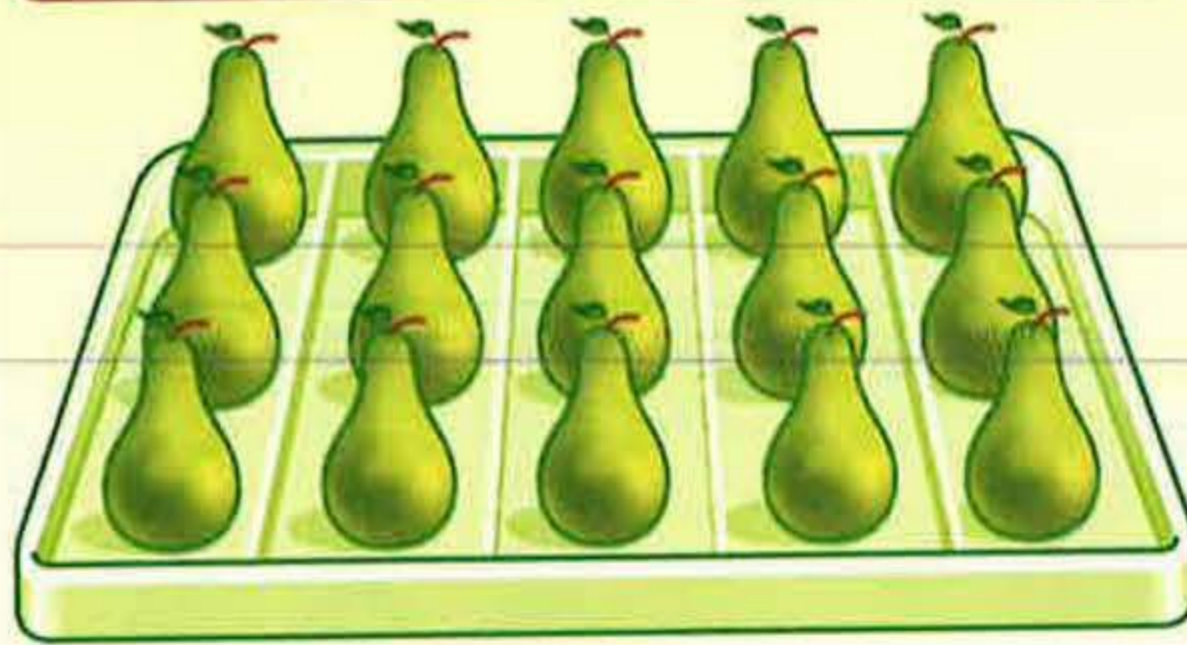
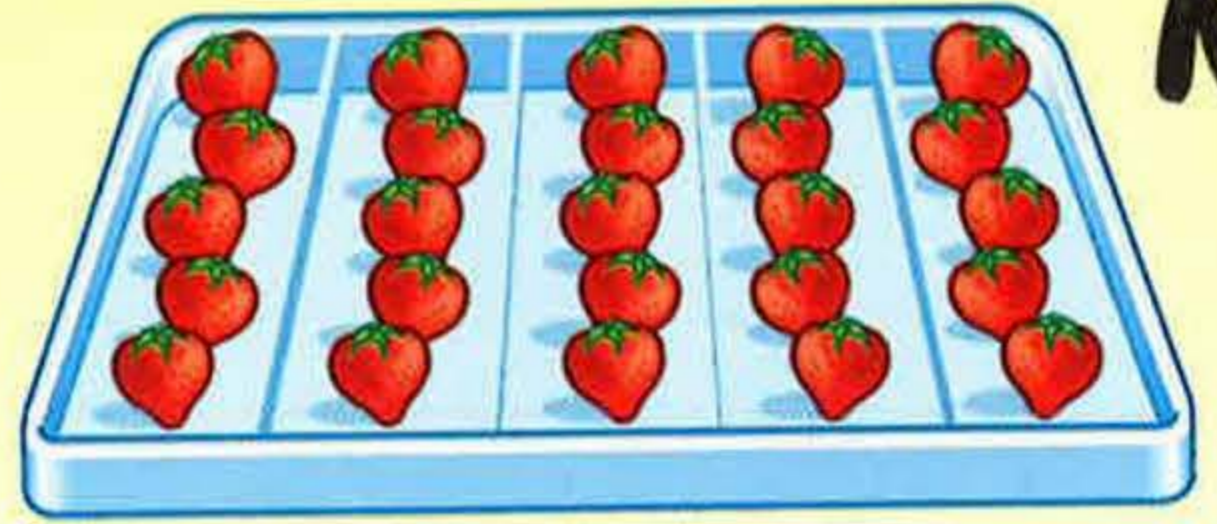
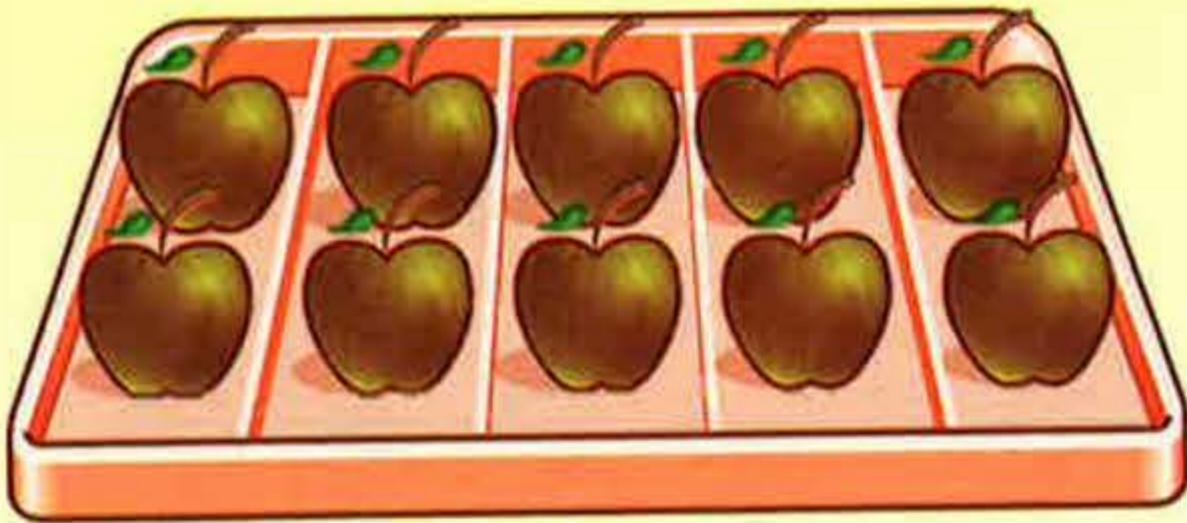

(b) Lorg còigeamh de na measan air gach treidhe.

(c) Dè tha thu a' mothachadh nuair a:

roinneas tu le 5

agus

lorgas tu còigeamh?

2 (a)  $\frac{1}{5}$  de 45

(b) còigeamh de 20

(c)  $\frac{1}{5}$  de 35

(d) còigeamh de 40

(e)  $\frac{1}{5}$  de 5

(f) còigeamh de 30

3 Chan eil dà chòigeamh de na bananathan deiseil airson an ithe.

Cia mheud còigeamh a tha **deiseil** airson an ithe?

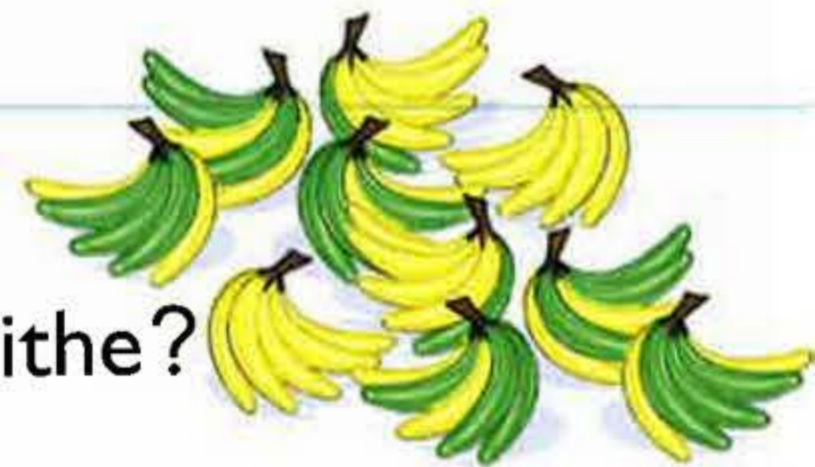

4 (a) Tha 50 ubhal ann am baraille.

Tha  $\frac{1}{5}$  de na h-ùbhlan dona.

Cia mheud **còigeamh** nach eil dona?

(b) Cia mheud **ubhal**: • a tha dona • nach eil dona?



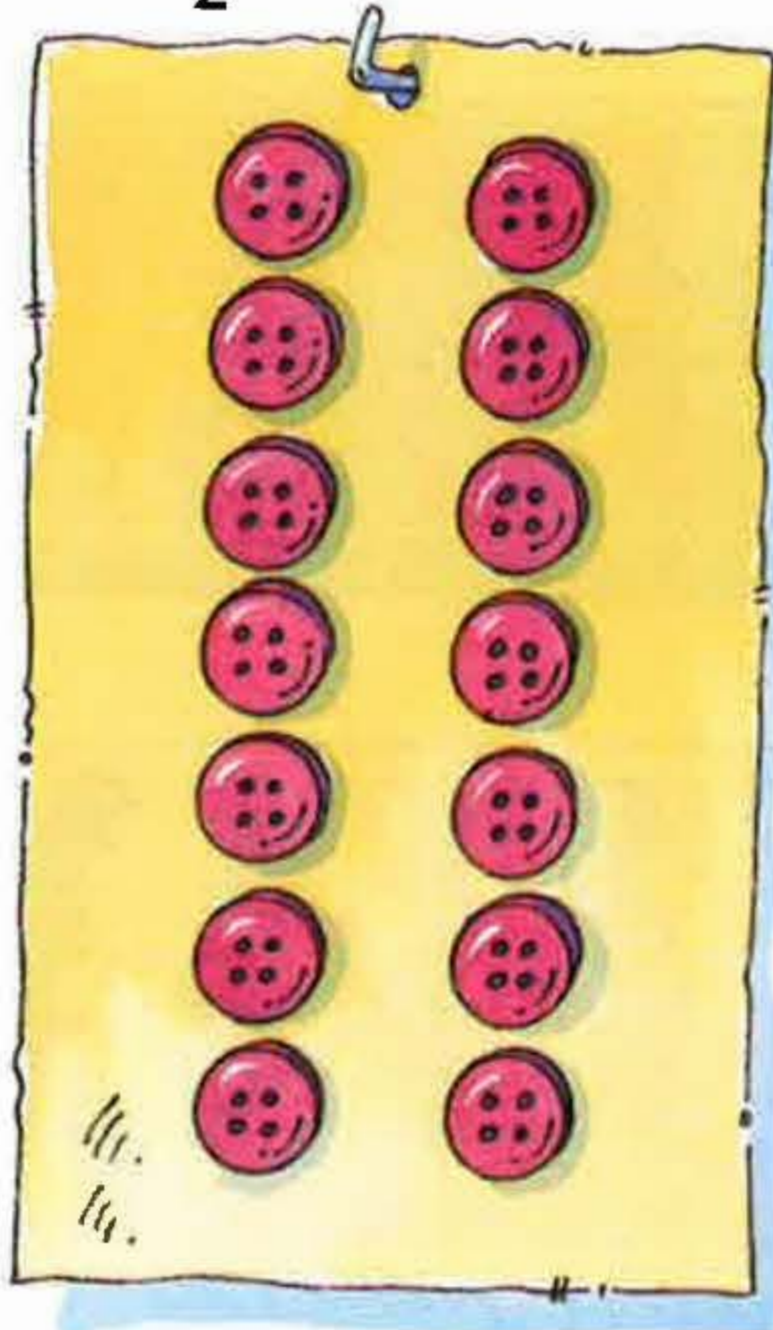
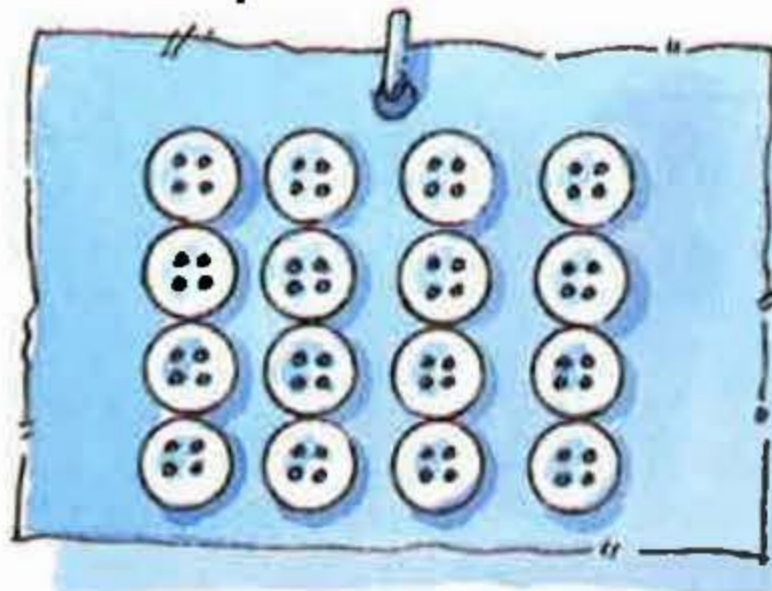
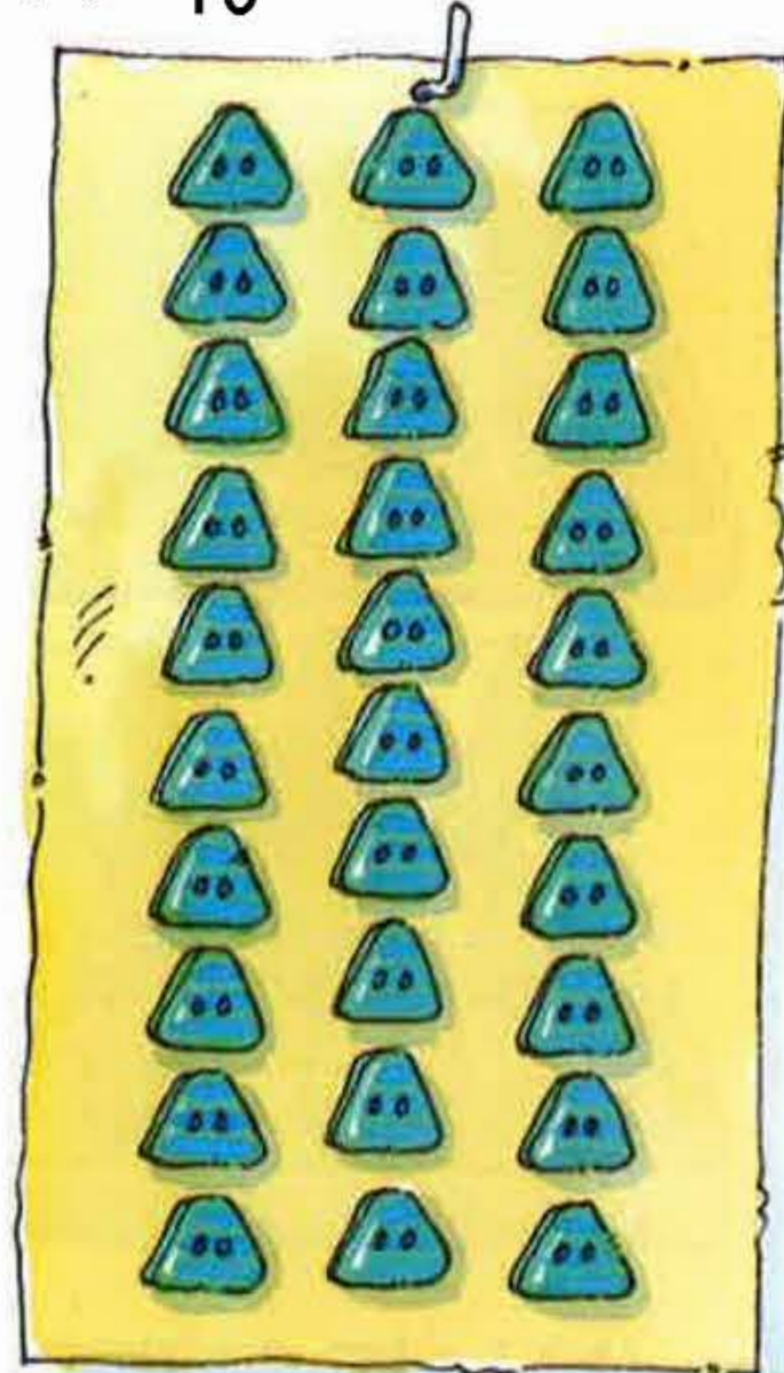
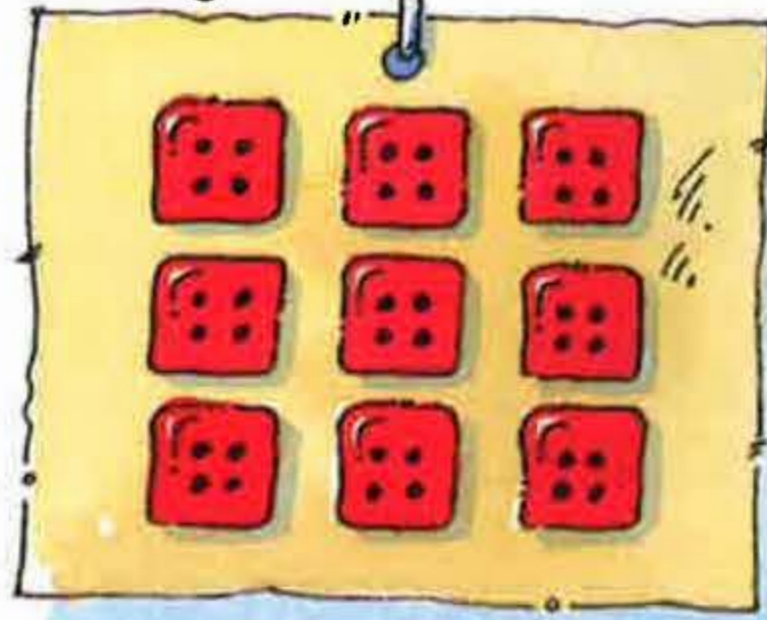
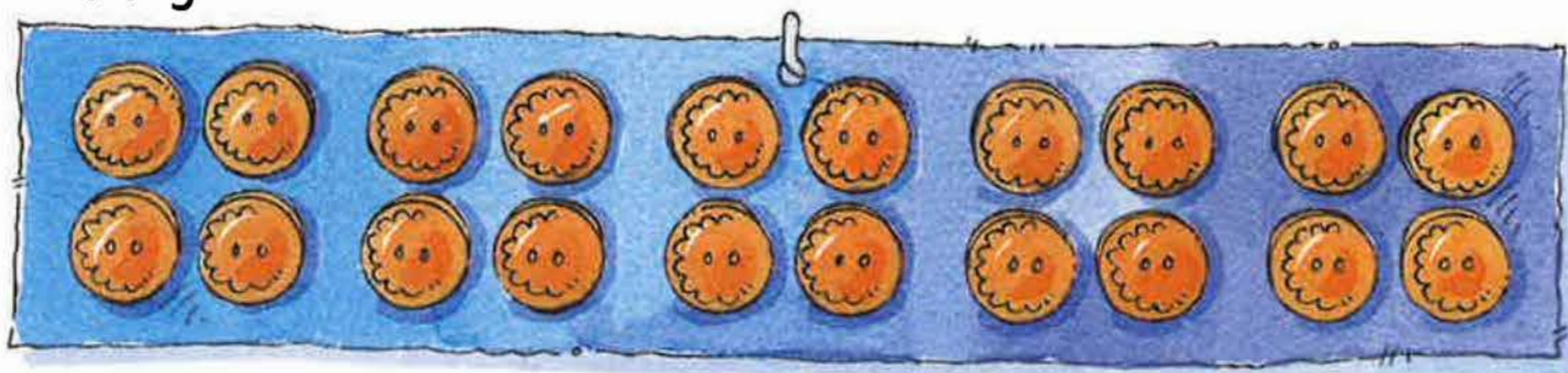

## 1 Lorg

(a)  $\frac{1}{2}$  de 14(b)  $\frac{1}{4}$  de 16(c)  $\frac{1}{10}$  de 30(d)  $\frac{1}{3}$  de 9(e)  $\frac{1}{5}$  de 20.2 (a)  $\frac{1}{5}$  de 40(b)  $\frac{1}{10}$  de 50

(c) treas de 18

(d)  $\frac{1}{4}$  de 28(e)  $\frac{1}{2}$  de 20

(f) deicheamh de 100

(g)  $\frac{1}{3}$  de 27(h)  $\frac{1}{10}$  de 80

(i) còigeamh de 45

(j)  $\frac{1}{3}$  de 15(k)  $\frac{1}{5}$  de 50

(l) treas de 21

3 Bha 30 putan aig Kim. Thug i  $\frac{1}{5}$  dhiubh dha Iain agus thug i  $\frac{1}{3}$  de na bha air fhàgail dha Raonaid.

Cia mheud putan a tha aig:

(a) Iain (b) Raonaid (c) Kim?





I Ath-sgrìobh agus crìochnaich gach eisimpleir de bhloighean co-ionnan.

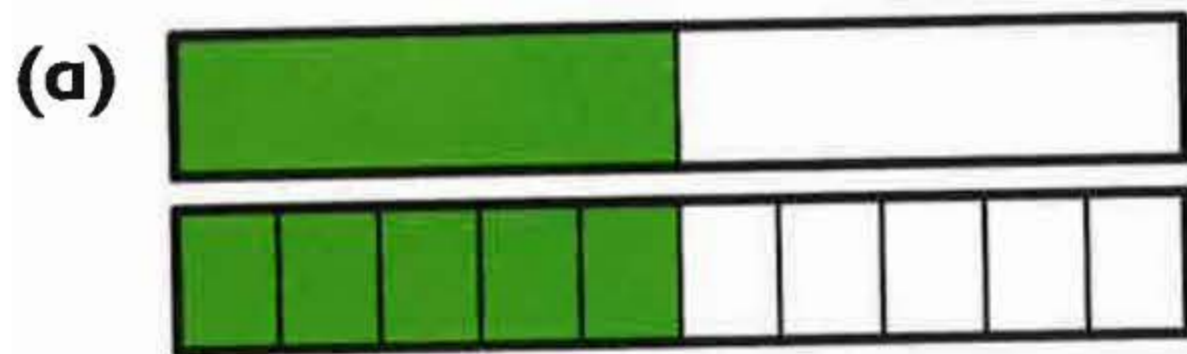

$$\frac{\text{■}}{2} = \frac{\text{■}}{10}$$

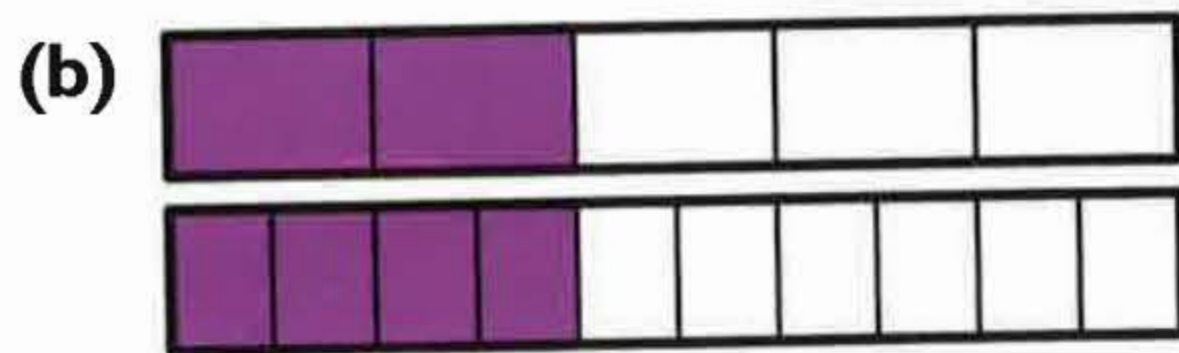

$$\frac{2}{\text{■}} = \frac{\text{■}}{10}$$

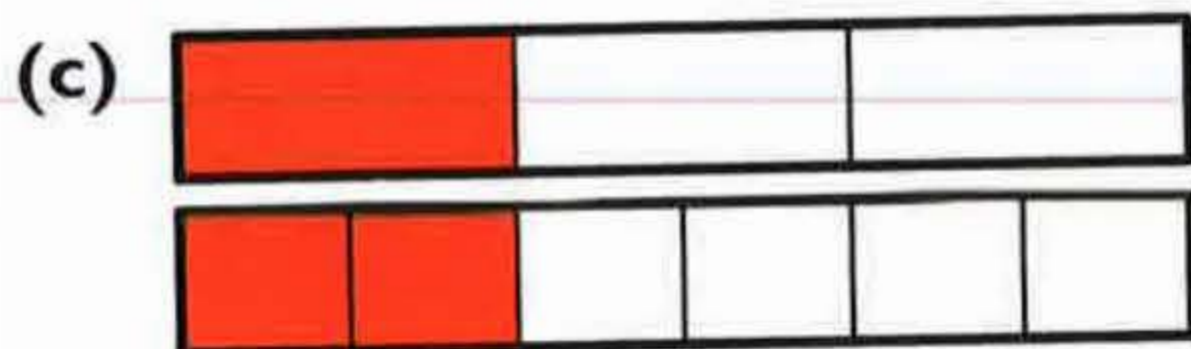

$$\frac{1}{\text{■}} = \frac{\text{■}}{6}$$

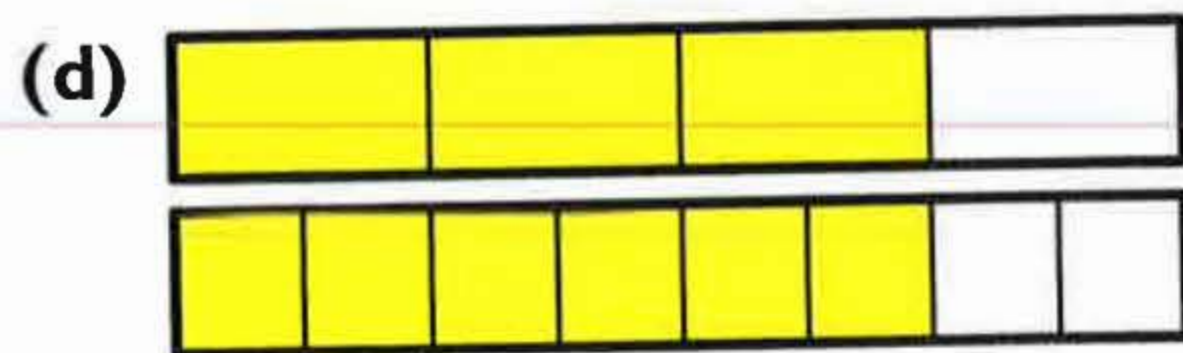

$$\frac{\text{■}}{4} = \frac{6}{\text{■}}$$

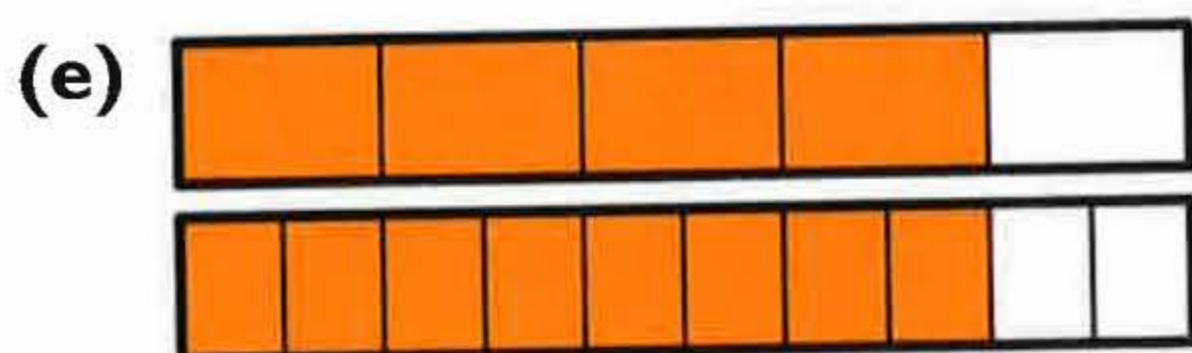

$$\frac{\text{■}}{5} = \frac{8}{\text{■}}$$

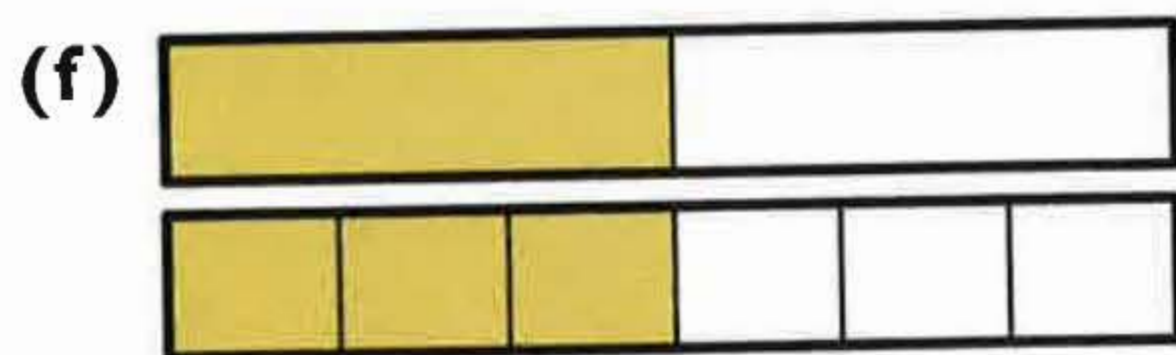

$$\frac{1}{\text{■}} = \frac{3}{\text{■}}$$

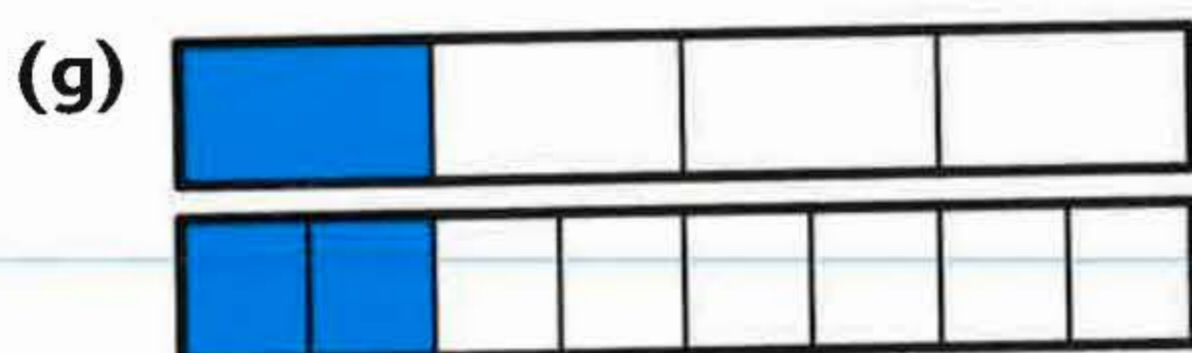

$$\frac{\text{■}}{\text{■}} = \frac{\text{■}}{\text{■}}$$

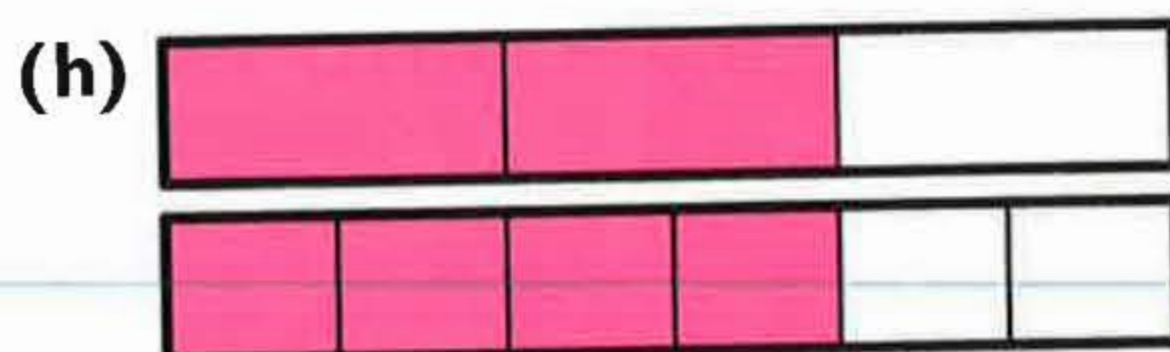

$$\frac{\text{■}}{\text{■}} = \frac{\text{■}}{\text{■}}$$

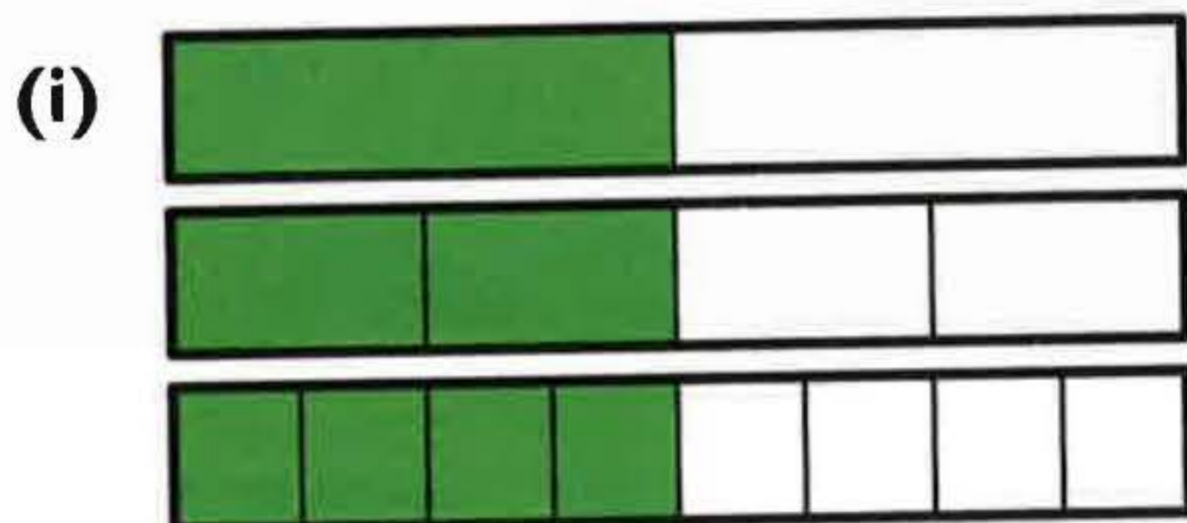

$$\frac{\text{■}}{\text{■}} = \frac{\text{■}}{\text{■}} = \frac{\text{■}}{\text{■}}$$



17 Dè na tha iad seo a' cosg?

(a)



(b)



(c)



(d)



2 Cò aige a tha barrachd airgid?

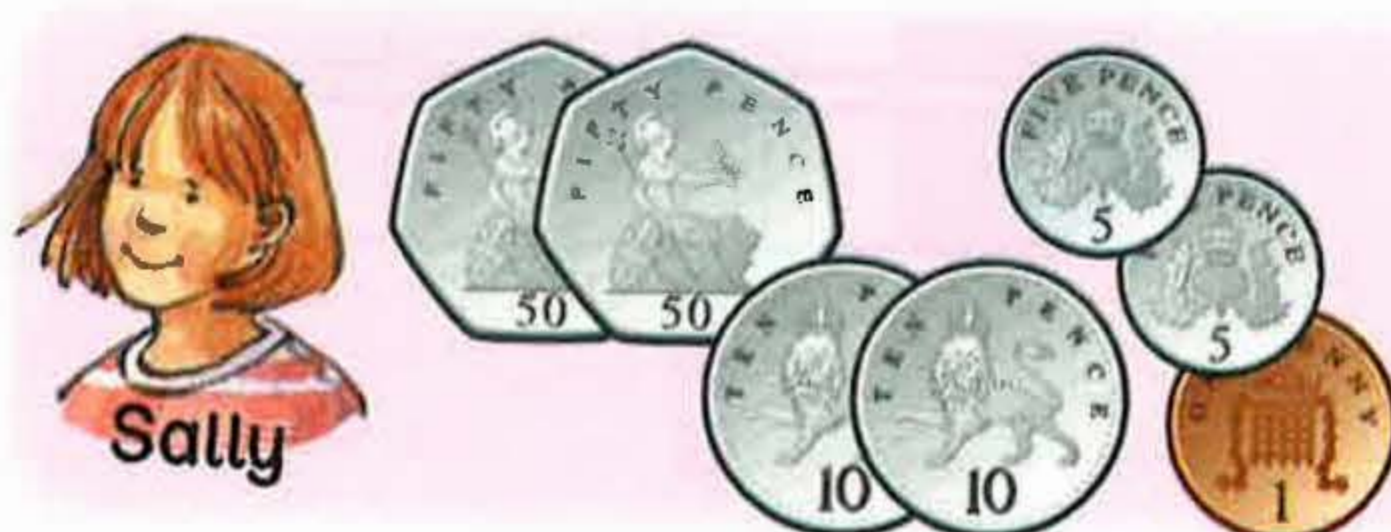

3 Cuir a-mach buinn gus gach rud a cheannach. Dèan liosta de na buinn.

(a)



(b)



(c)





1 Cia mheud de gach bonn a dh'fheumadh tu airson £2 a dhèanamh?



2 Dè a' phrìs a tha iad seo?

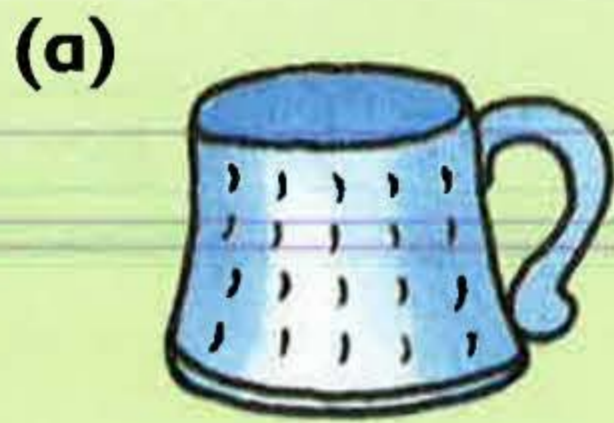

3 Dèan liosta de na buinn a dh'fheumas tu gus gach rud a cheannach. Cleachd cho beag 's as urrainn dhut de bhuinn.



£2.80



£5.43



£9.65



£7.98

4 Dè an rud (a) as daoire (b) as saoire a tha ann?

5 Tagh às na buinn seo. Sgrìobh ceithir dòighean eadar-dhealaichte gus £5 a dhèanamh.





**1** Sgrìobh na buinn a gheibh thu air ais bho £1 nuair a cheannaicheas

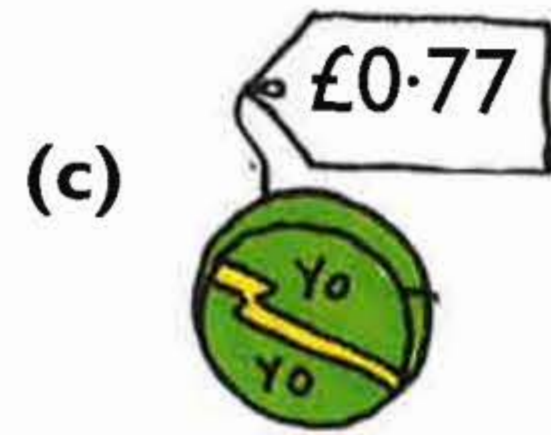
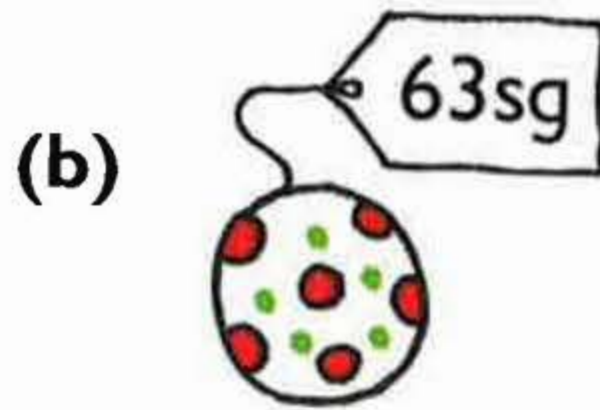
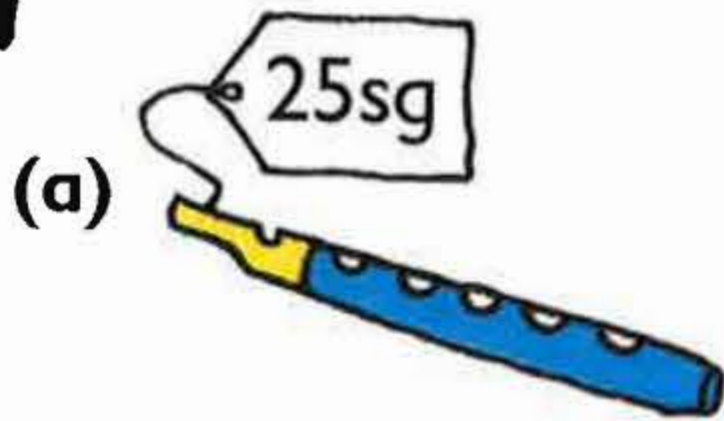

**2** Sgrìobh na buinn a gheibh thu air ais bho £2 nuair a cheannaicheas tu

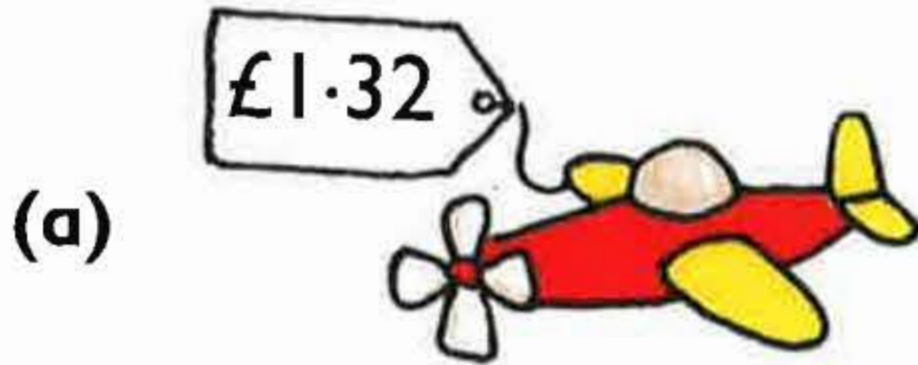

**3** Dè na tha aig gach leanabh air fhàgail?



**4** Dè na tha aig gach leanabh air fhàgail?



**5** Cheannaich Suzy dèideag. Phàigh i air a son le bonn £2.



Dè na chosg i?



Tha Daibhidh air £1.34 a shàbhaladh



1 Sgrìobh gach suim ann an notaichean agus sgillinnean.

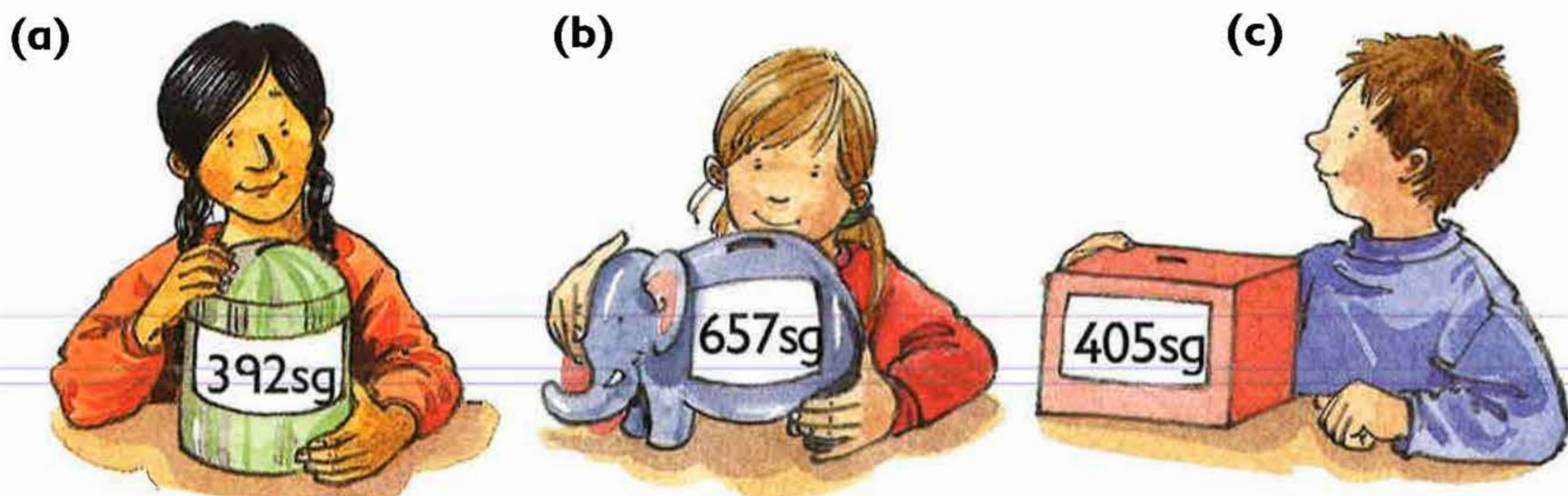

(d) 213sg

(e) 860sg

(f) 442sg

(g) 131sg

(h) 950sg

(i) 728sg

(j) 504sg

(k) 96sg

2 Sgrìobh gach suim ann an sgillinnean.

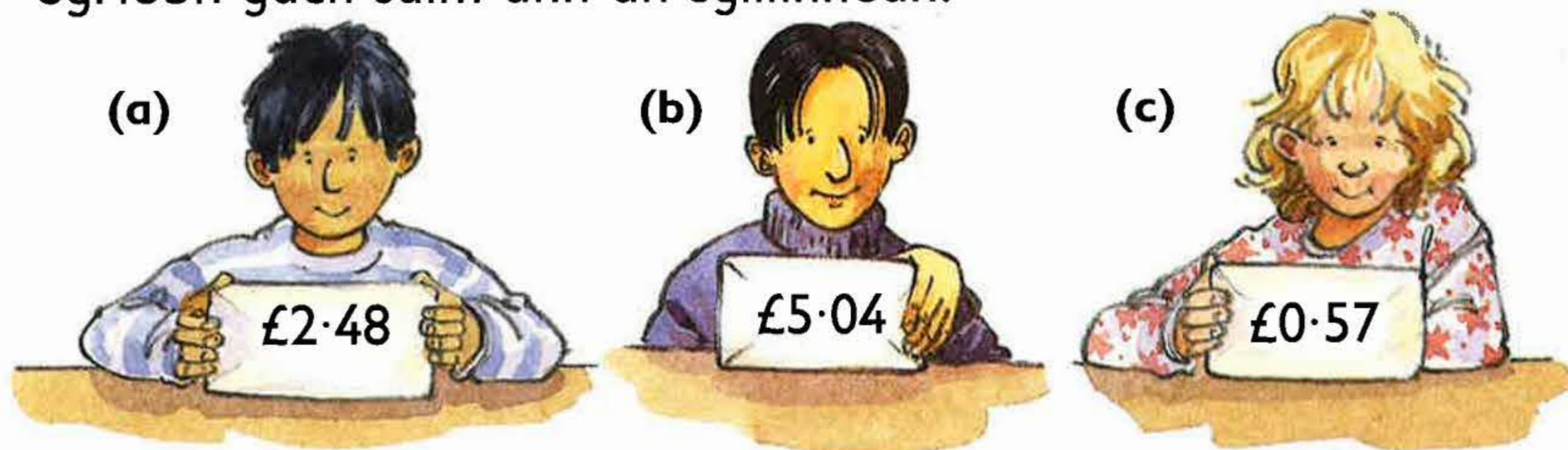

(d) £9.35

(e) £3.61

(f) £1.53

(g) £6.29

(h) £5.70

(i) £8.06

(j) £7.90

(k) £4.00

3



Dè am banca anns a bheil an t-suim airgid (a) as motha (b) as lugha?



7 Lorg na tha aig gach leanabh de dh'airgead.



Tim



Zoe



Mia



Jack



2 Seat a-mach agus dèan liosta de na notaichean agus na buinn a dh'fheumar airson gach rud.

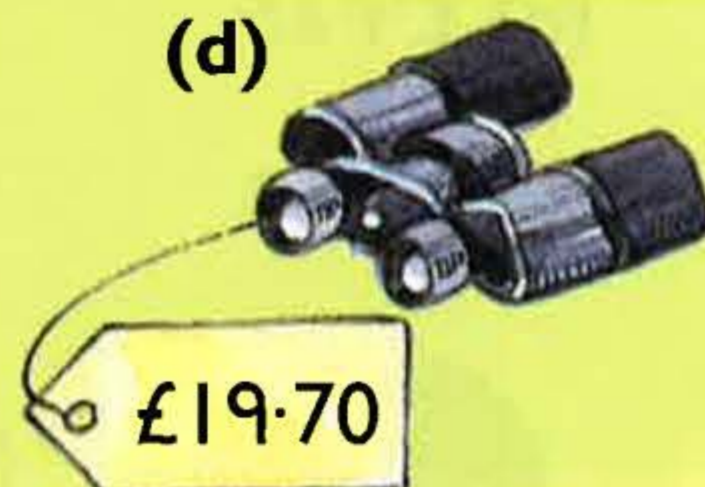
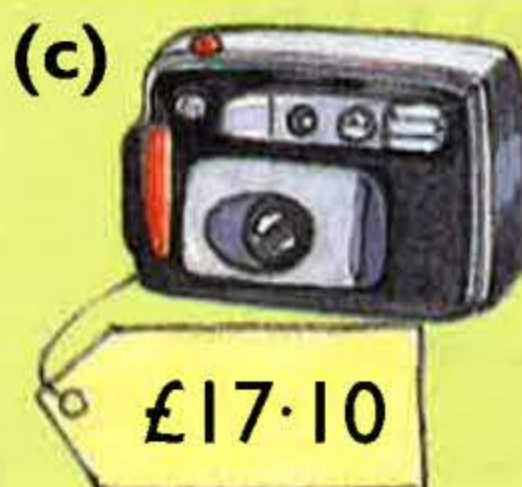
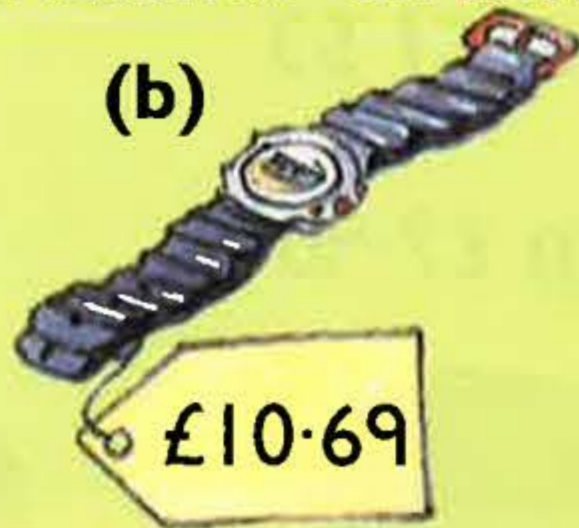

3 Sgrìobh an t-suim a tha nas motha na prìs an



ach nas lugha na prìs an





I Dè na tha aig gach leanabh de dh'airgead?

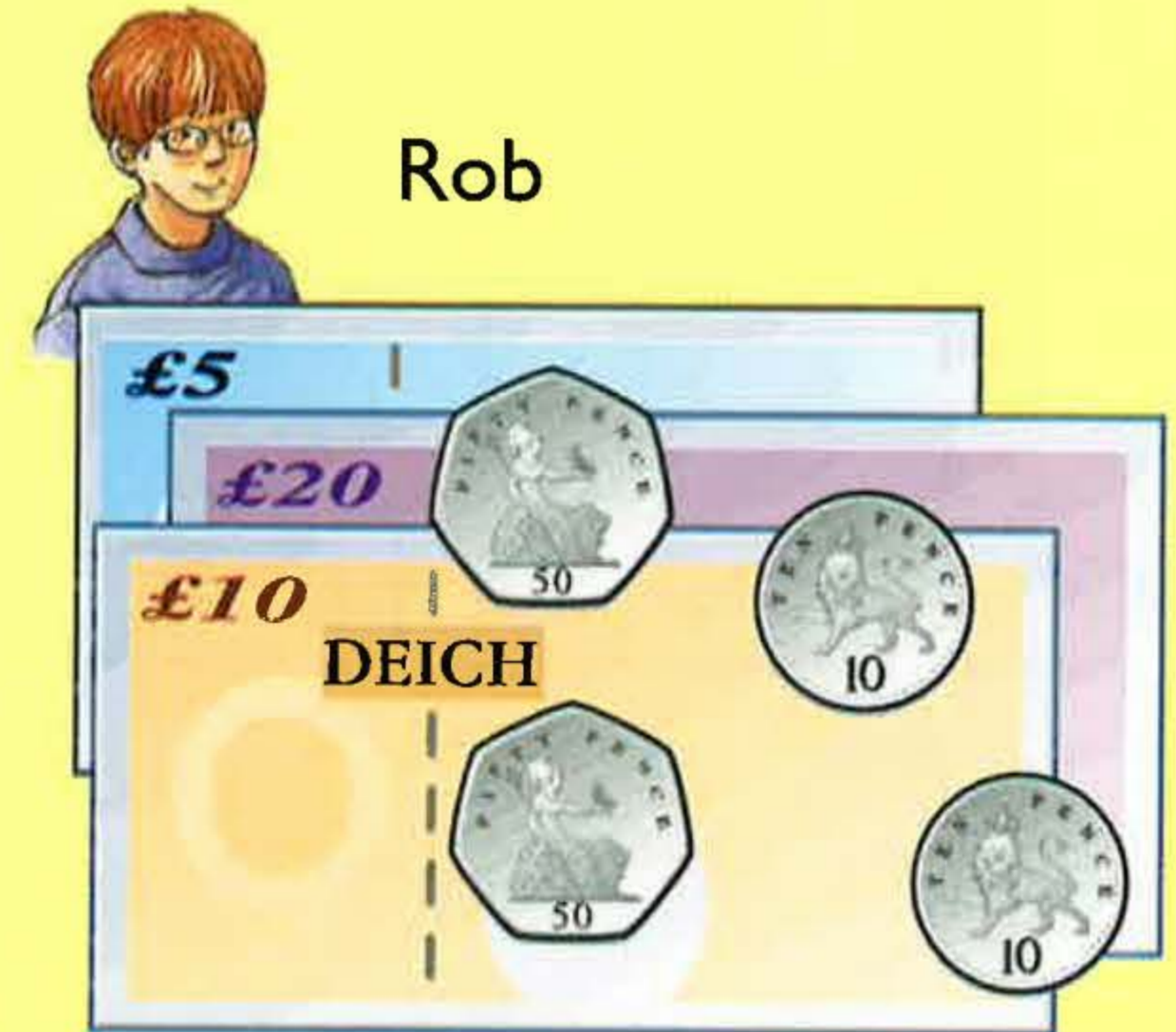
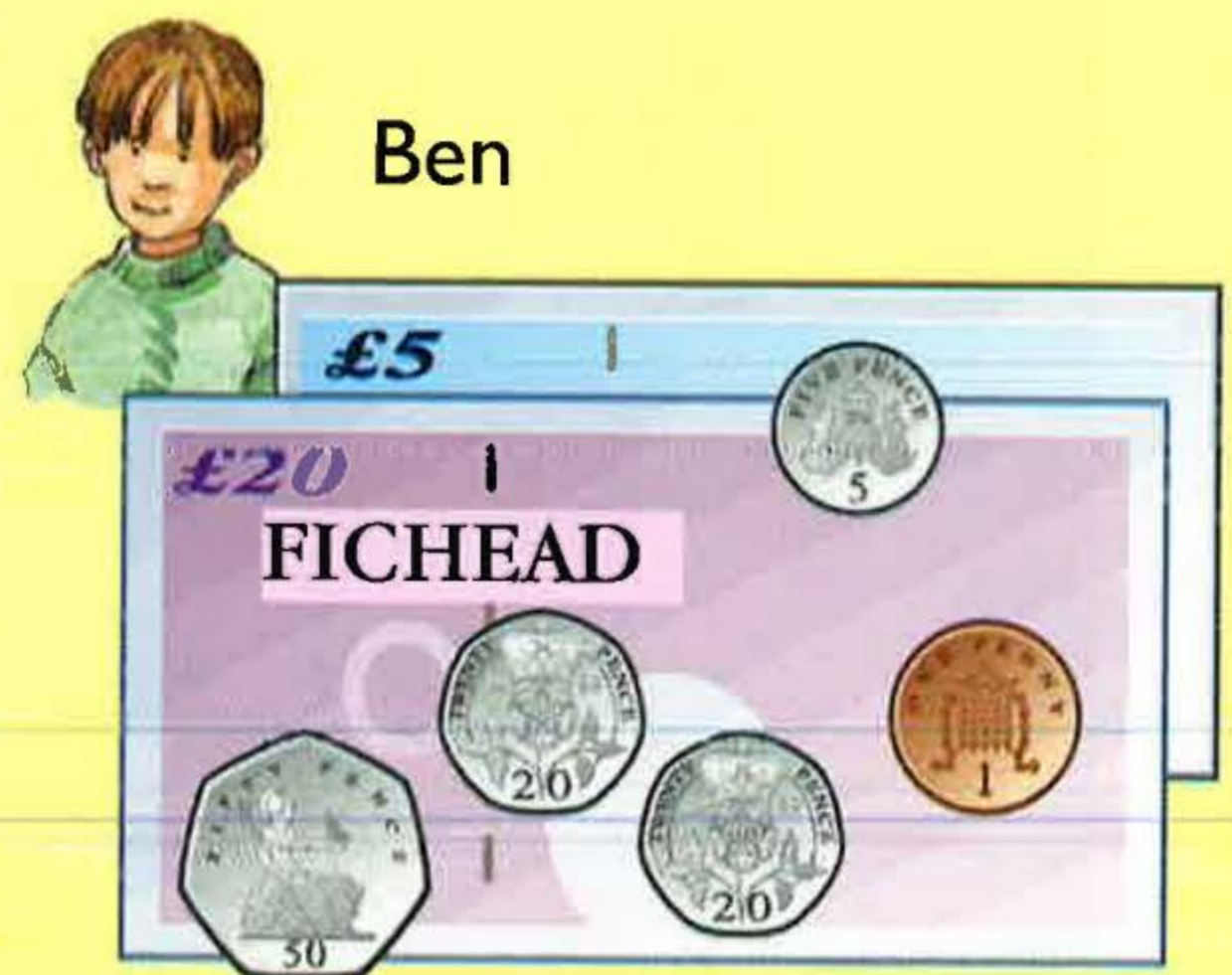

2 Seat a-mach agus dèan liosta de na notaichean agus na buinn a dh'fheumar airson gach rud.

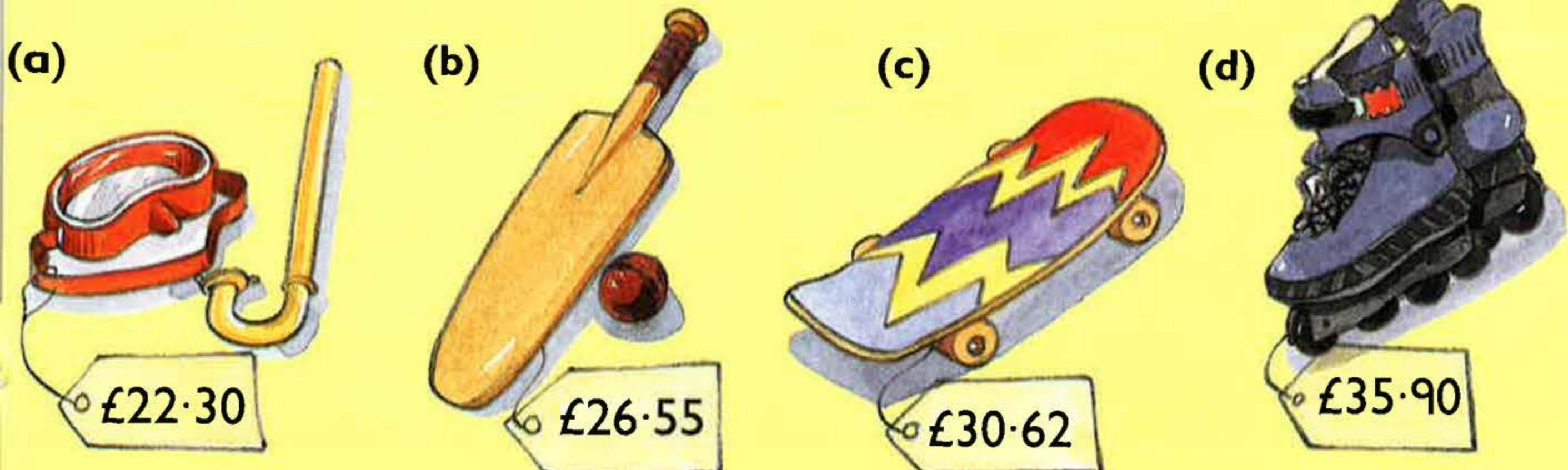



1 Sgrìobh na buinn a tha ann an iomlaid gach leanabh.

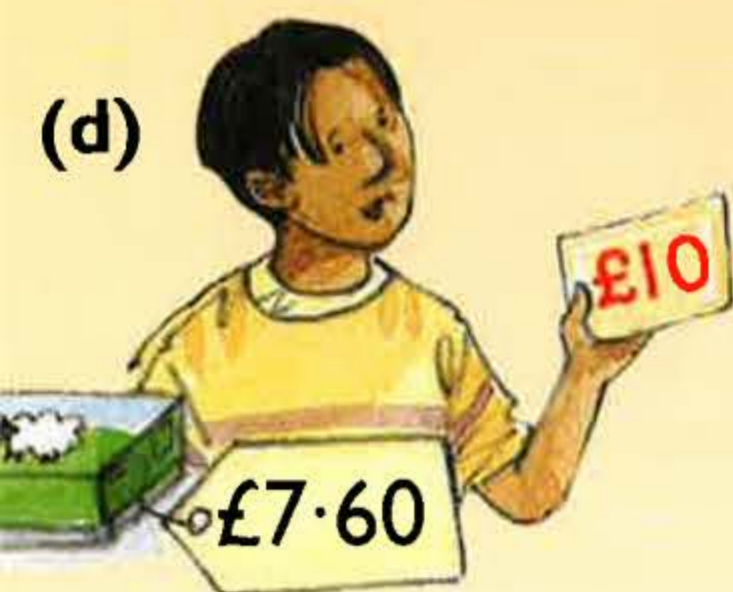
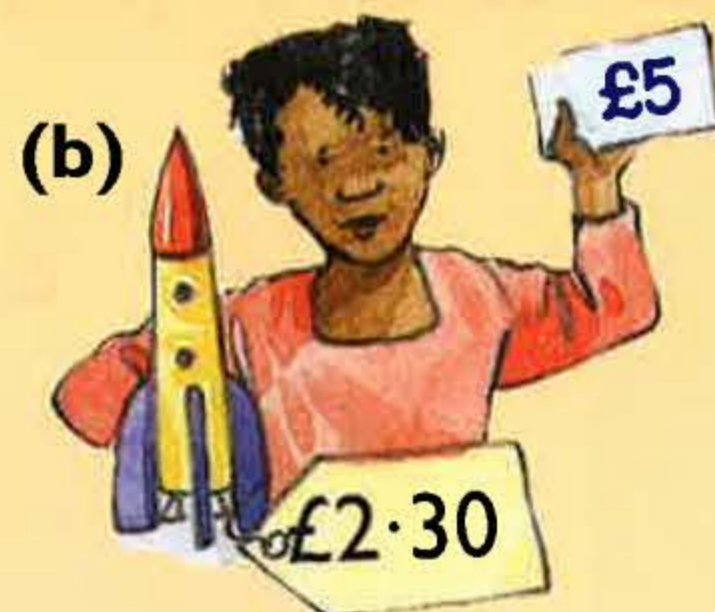

£0.40	£1.20	£0.70	£0.90	£2.30	£1.50

2 Lorg prìs:

- (a) bàlla agus bràiste (b) doile agus peann (c) bàlla agus doile  
(d) làraidh agus doile (e) peann agus bràiste (f) bratach agus bràiste.

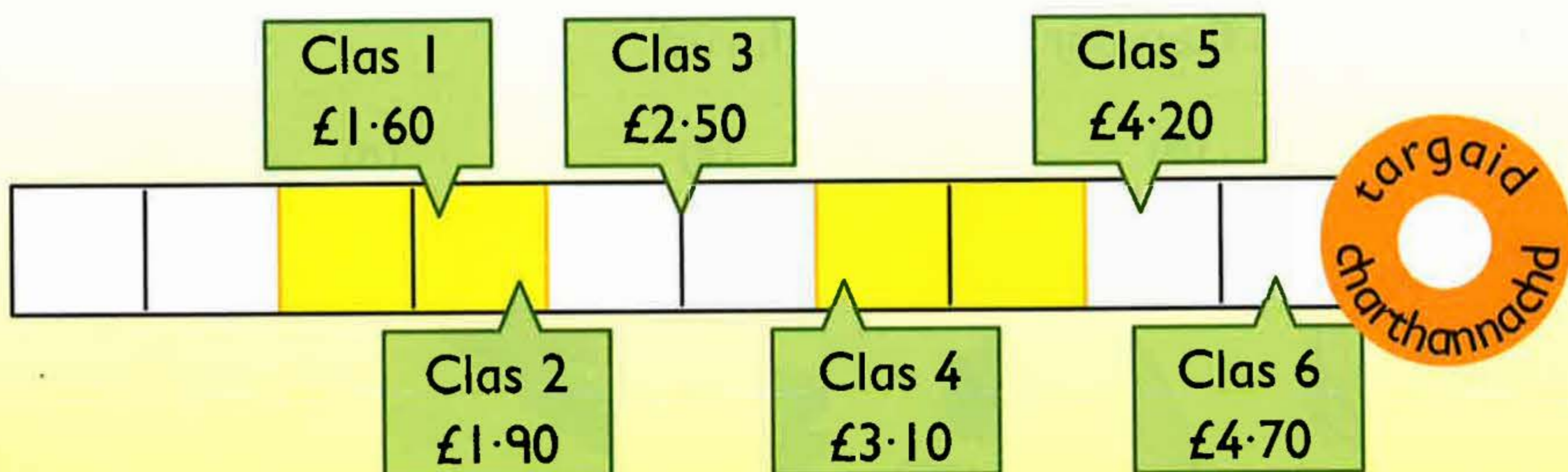

3 Dè na tha aig gach clas fhathast ri chruinneachadh?



- 1 Dè na plèanaichean air a bheil àireamhan a tha nan iomadan de  
 (a) 2                      (b) 5                      (c) 10                      (d) 2, 5 agus 10?

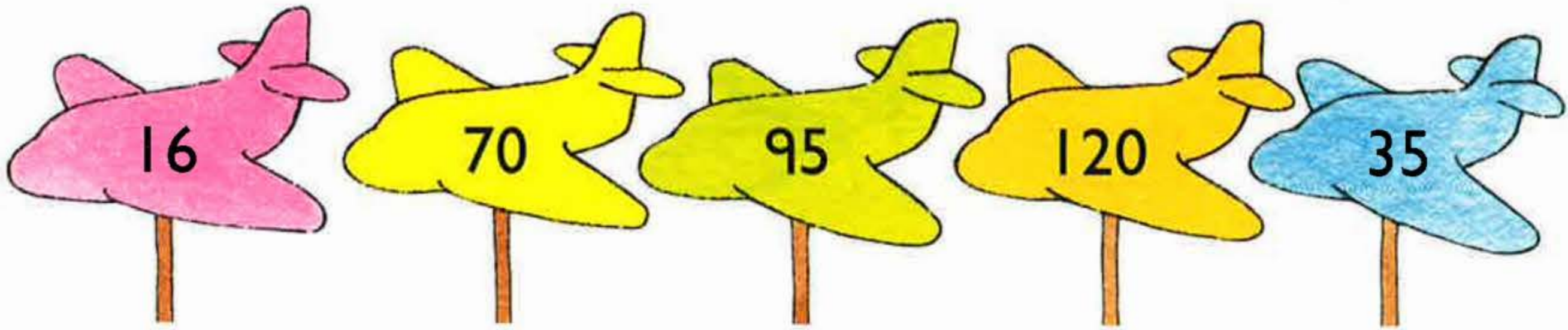

2

### Cleasachd Tombola

- tha iomadan de 3 a' buannachadh bhidio
- tha iomadan de 5 a' buannachadh bailiùn
- tha iomadan de 3 **agus** 4 a' buannachadh leabhar.



Dè a bhuannaicheas na ticeadan seo?



3



Buail 3 iomadan de cheithir airson teadaidh a bhuannachadh no 3 iomadan de chòig airson cnò-còco a bhuannachadh.

Dè na cairtean a dh'fhaodadh tu bualadh gus:  
 (a) teadaidh    (b) cnò-còco a bhuannachadh?





# 1 Cleachd



Cia mheud leabhar-teacs matamataigs còmhla anns a bheil cuideam:

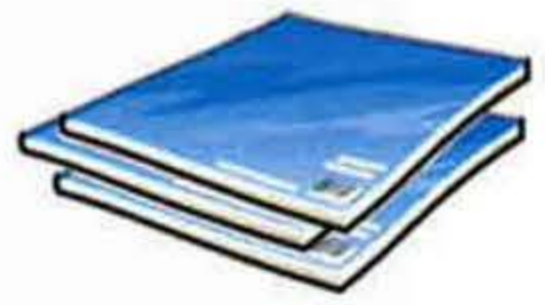

(a) mu 1 cg    (b) mu  $\frac{1}{2}$  cg?

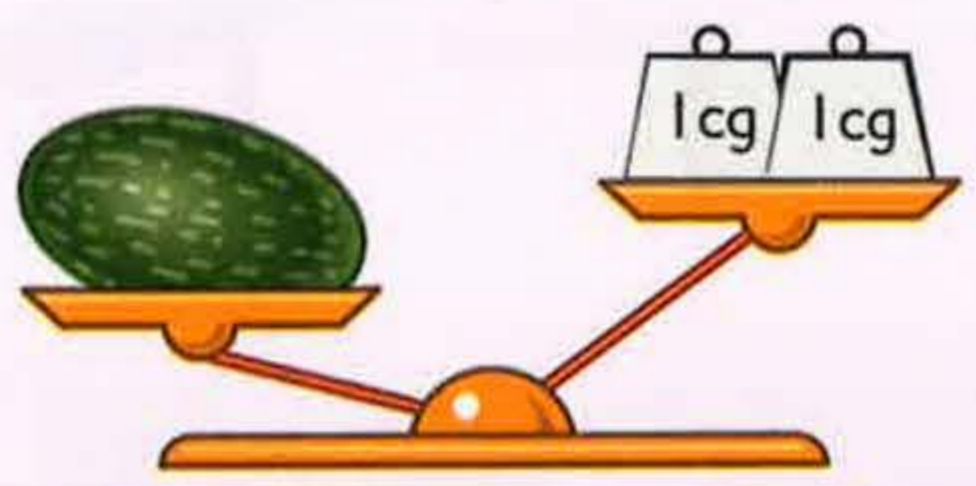

Tha barrachd air 2cg a chuideam anns a' mheal-bhuc.

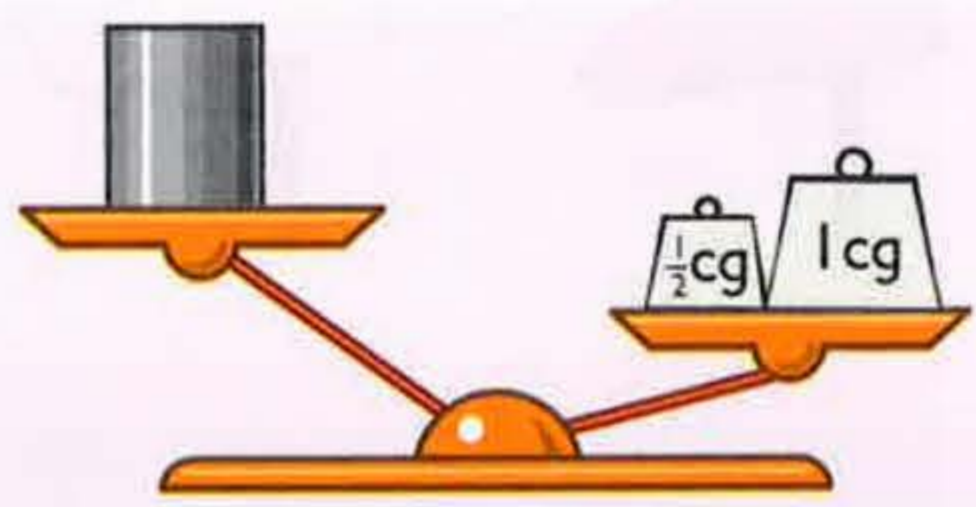

Tha nas lugha na  $1\frac{1}{2}$  cg a chuideam anns an tiona.

## 2 Sgrìobh mu chuideam gach rud anns na dealbhan seo.

Gainmheach

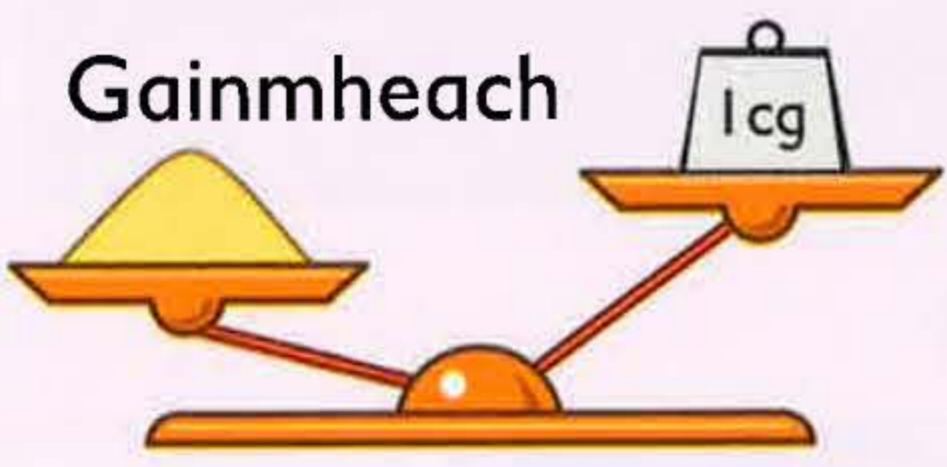

clachan

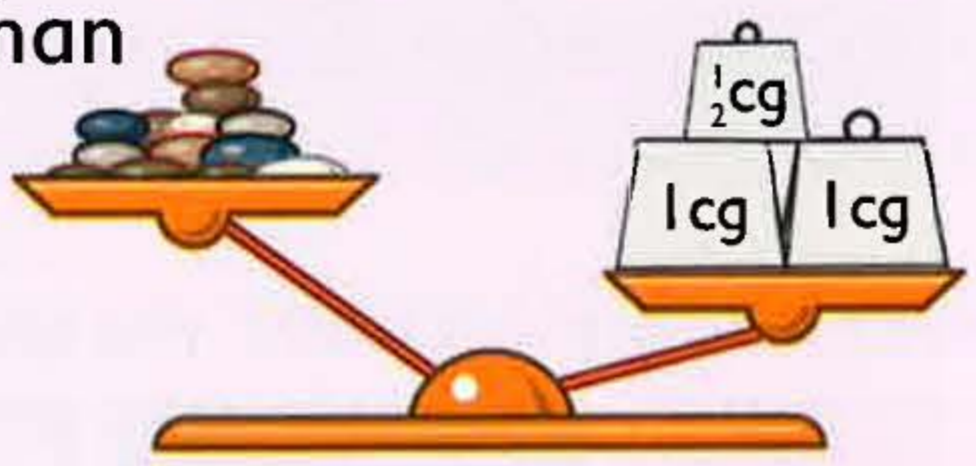

sligean

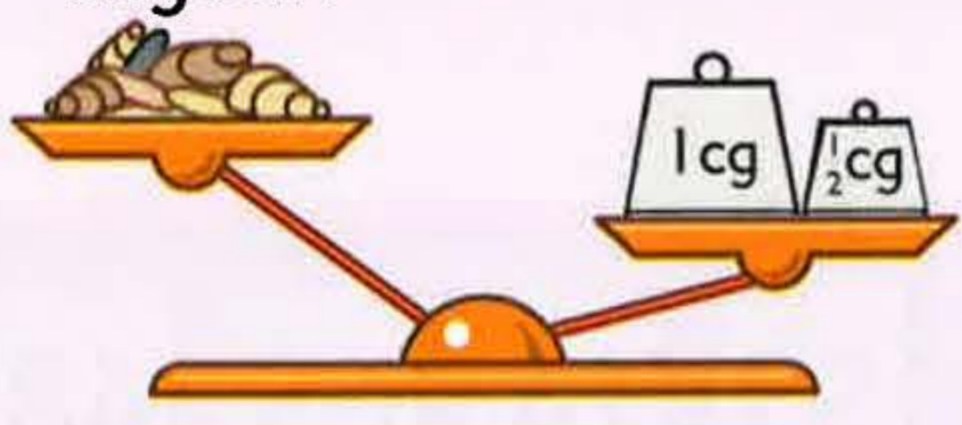

peapag



flùr

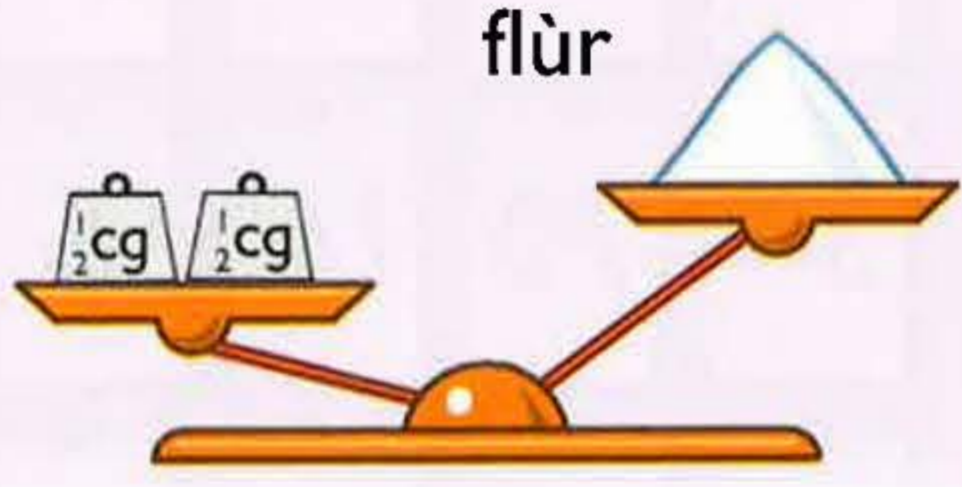

bananathan

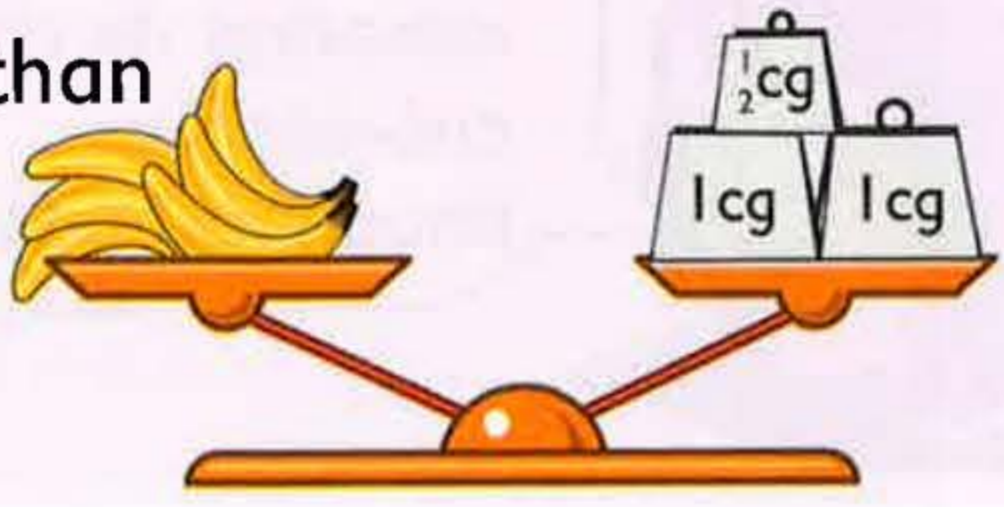

## 3 Lorg rud air choireigin a thuirmeadh tu anns a bheil cuideam eadar 2cg agus 3cg.



Tha cuideam anns an rus timcheall

$2\frac{1}{2}$  cg

no

2cg 500g

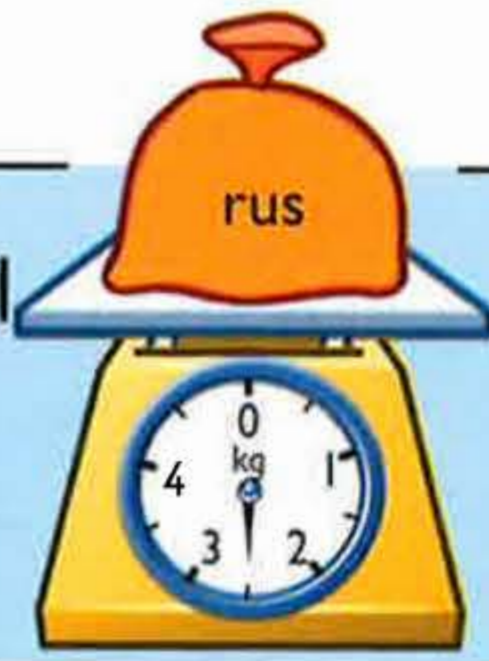

I Sgrìobh gach fear de na cuideaman seo ann an dà dhòigh.

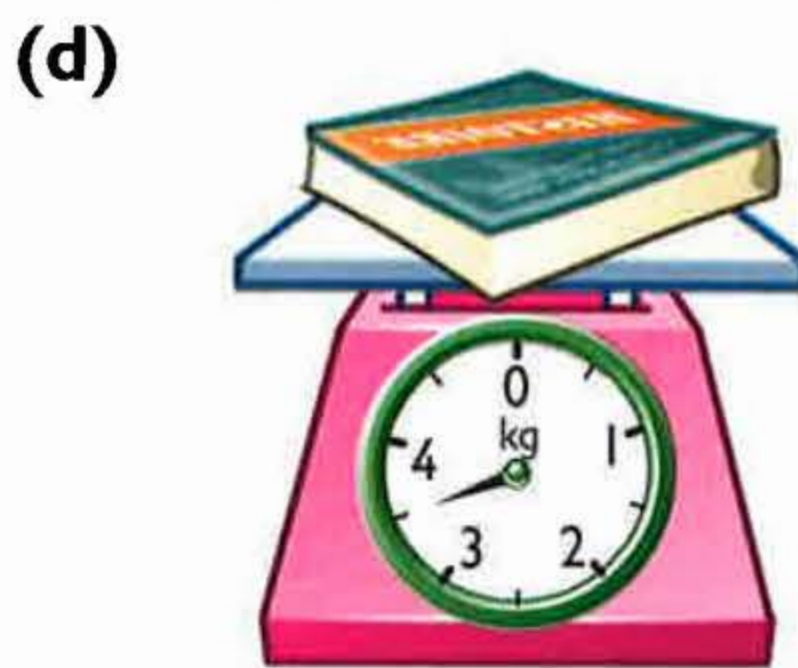
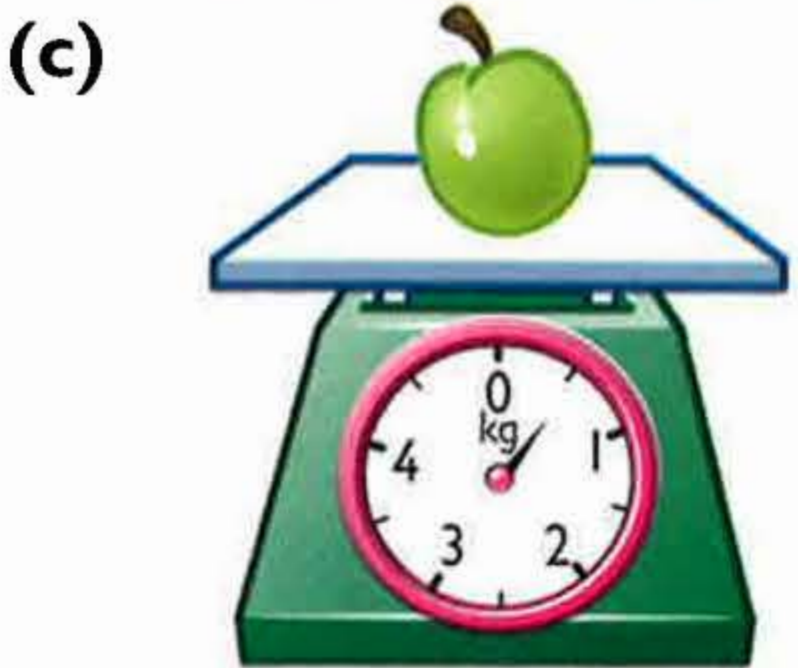
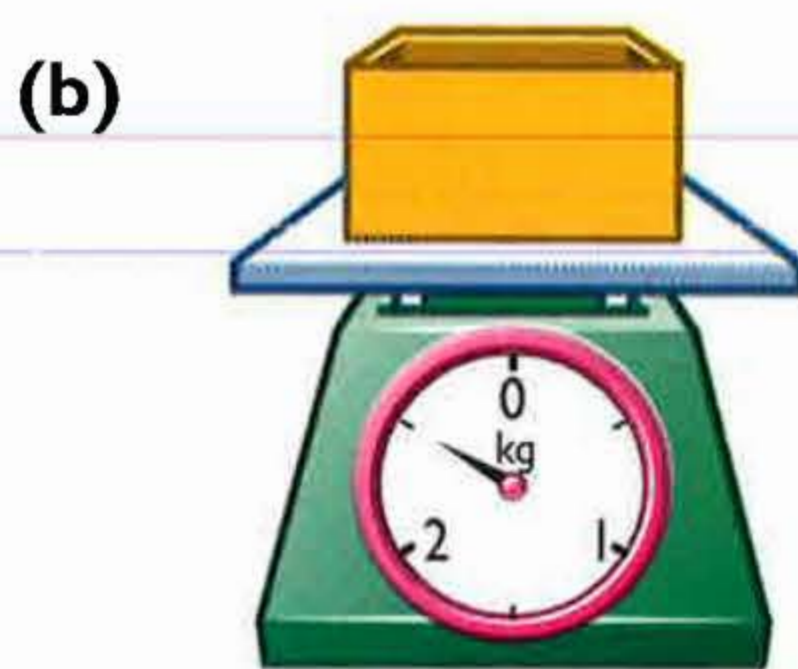
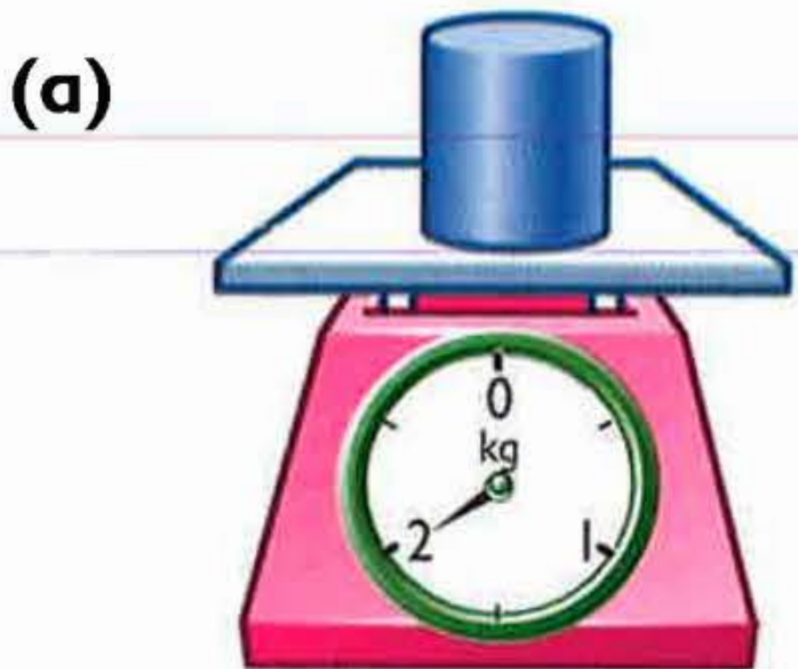

2 Lìon botal mòr le uisge.  
Lorg an cuideam aige.

3 Cothromaich 1cg 500g de  
ghainmhich ann am bogsa.







- Dè na rudan anns a bheil cuideam:
  - nas motha na  $\frac{1}{2}$  cg
  - nas lugha na  $\frac{1}{2}$  cg?
- Dè an **dà** rud còmhla anns am biodh cuideam:
  - $\frac{1}{2}$  cg
  - 1 cg?
  - $1\frac{1}{2}$  cg?
- Dè na **trì** rudan còmhla anns a bheil cuideam 1cg?
- Maids gach rud ris a' chuideam cheart.

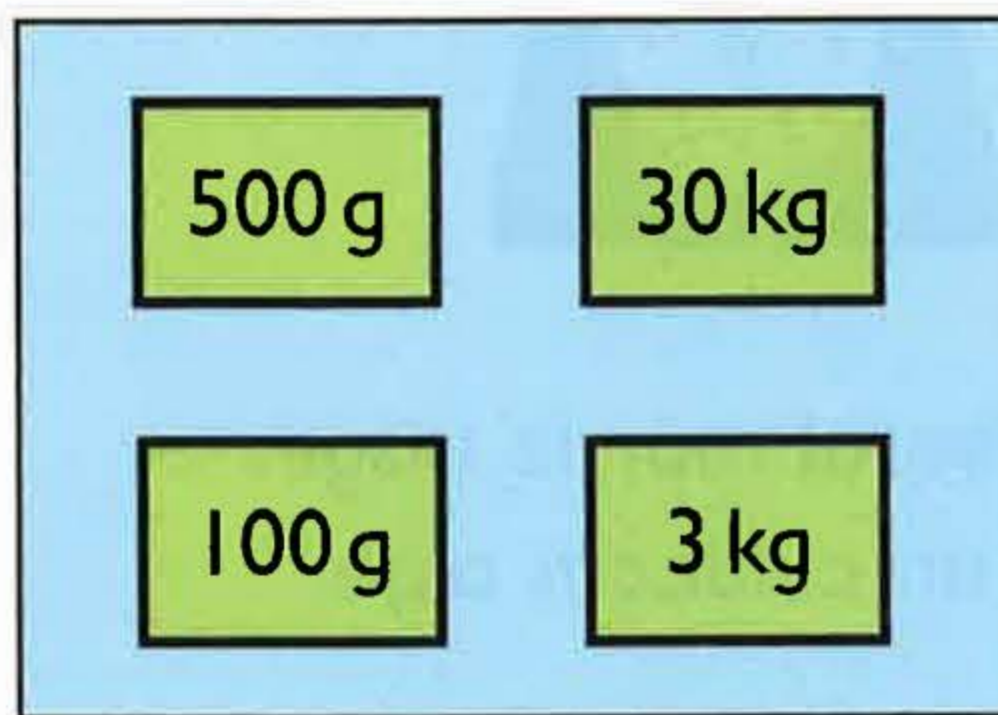
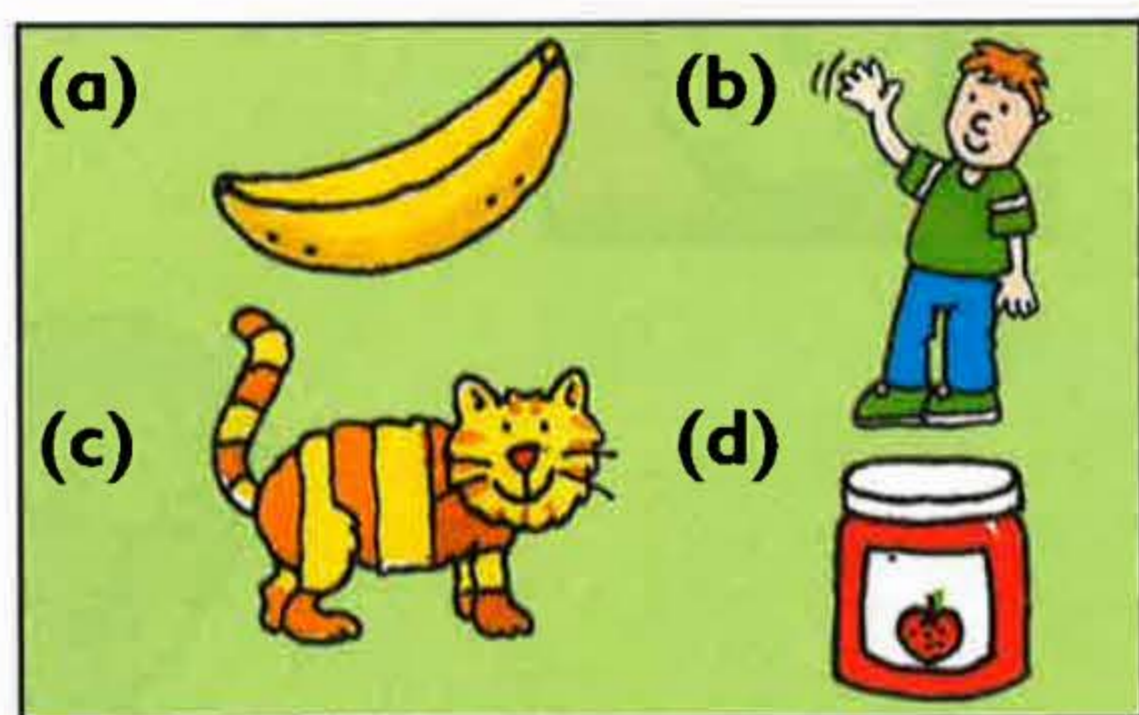

- Tagh an cuideam airson gach rud.

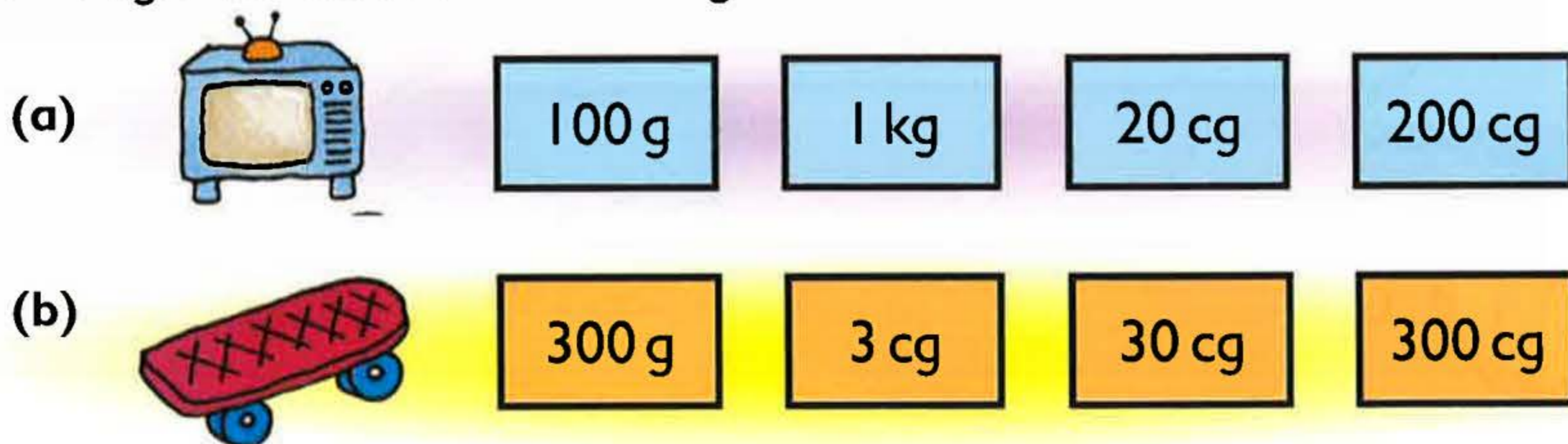



1 Lorg faid gach rud.

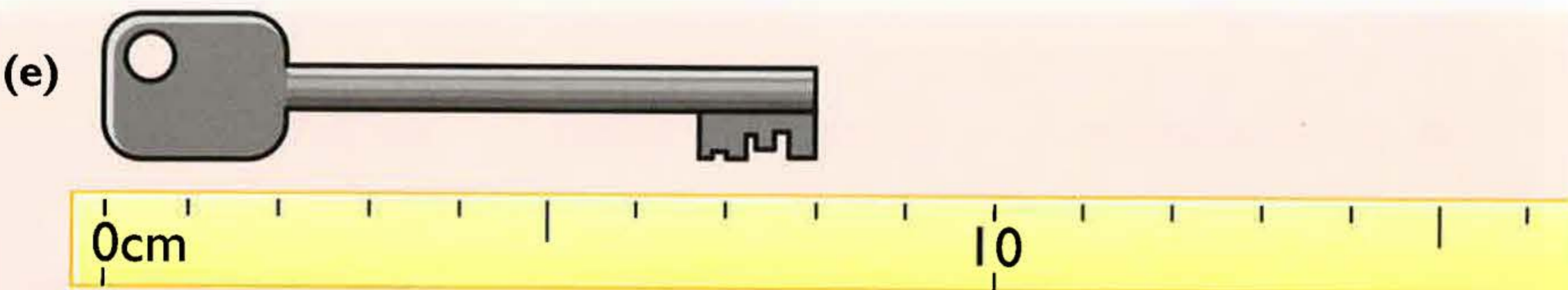
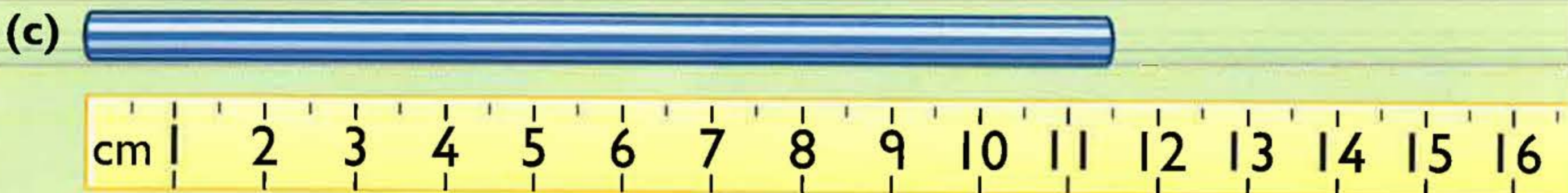

2 Tomhais gach loidhne. Sgrìobh faid gach loidhne.

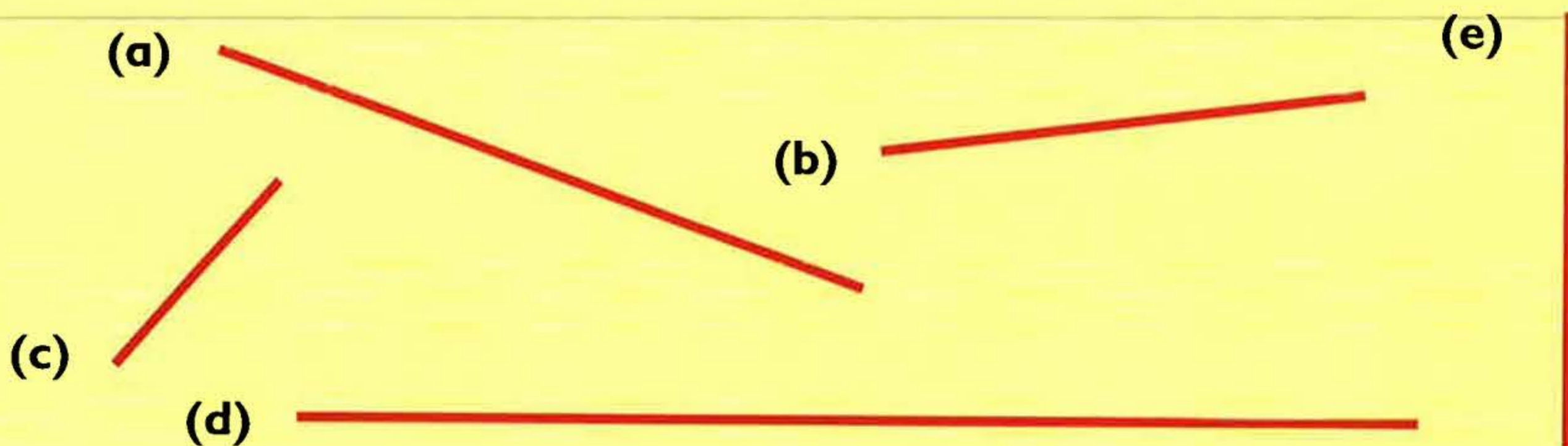

3 Dealbh loidhnichean de na faidean seo.

- (a) 10 cm    (b)  $3\frac{1}{2}$  cm    (c) 6 cm    (d)  $12\frac{1}{2}$  cm



Cleachd teip tomhais, agus dèan seo còmhla ri caraid.



I Tomhais an t-astar mu:

(a) do cheann

(b) d' amhaich

(c) do bhroilleach



(d) do mheadhan

(e) caol do làimh

(f) d' aobrann



(g) mullach a' bhiona

(h) botal plastaig

(i) cearclan

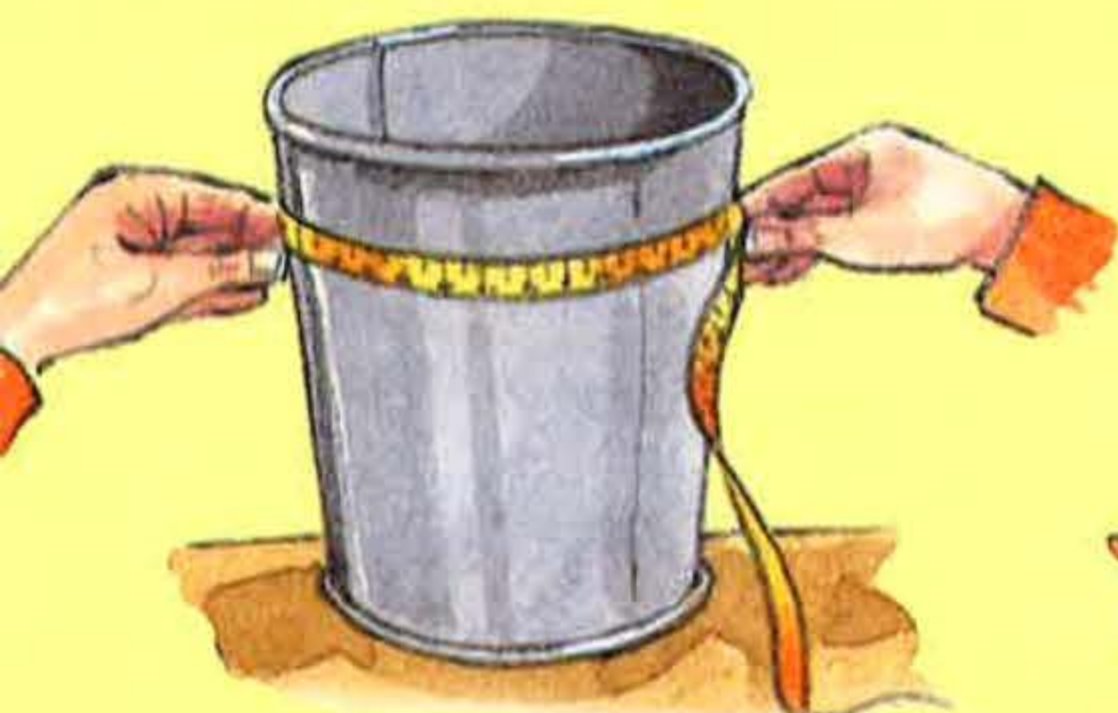



Cleachd uisge no gainmheach,



agus



1 liotair

$\frac{1}{2}$  liotair

**1 Feumaidh tu sia soithichean mar an fheadhainn seo.**

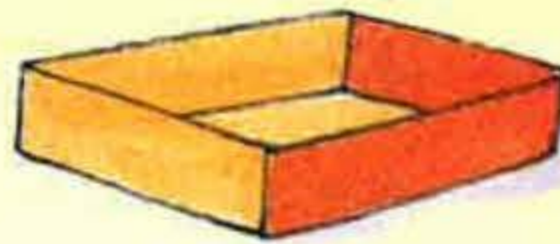

Faigh a-mach gu dè na soithichean a ghabhas:

(a) nas lugha na  $\frac{1}{2}$  liotair

(b) mu  $\frac{1}{2}$  liotair

(c) barrachd air  $\frac{1}{2}$  liotair.



**2 Feumaidh tu ceithir tubaichean.**

Le bhith ga thomhas cuir na tha air gach bileig dha gach tuba



1 liotair



$\frac{1}{2}$  liotair

$1\frac{1}{2}$  liotair



2 liotair



**3 Feumaidh tu trì soithichean mar an fheadhainn seo.**

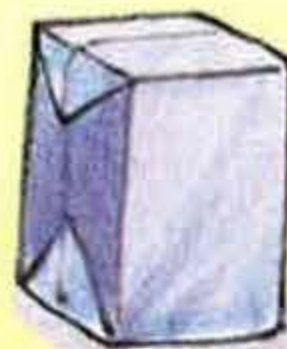
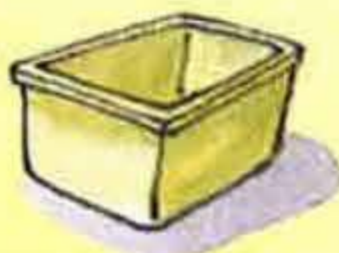

Dèan tuairmse air na ghabhas gach fear. An uair sin tomhais na ghabhas iad.



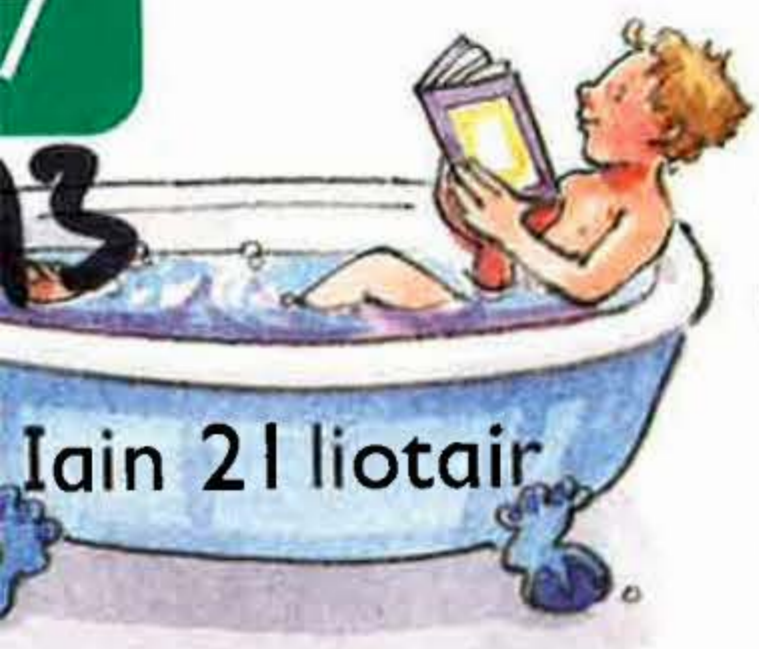

- 1 Cia mheud liotair a tha air a chleachdadh gu lèir le:  
 (a) Iain agus Ailig (b) Ailig and Kate (c) an triùir aca?
- 2 Cia mheud liotair a tha air a chleachdadh le:  
 (a) Ceit a bharrachd air Ailig (b) Ailig a bharrachd air Iain  
 (c) Ceit a bharrachd air Iain?
- 3 Ciamar a gheibh Eilidh air 3 liotairean de dh'uisge a thomhas dhan mhìos?  
 Lorg trì diofar dhòighean.

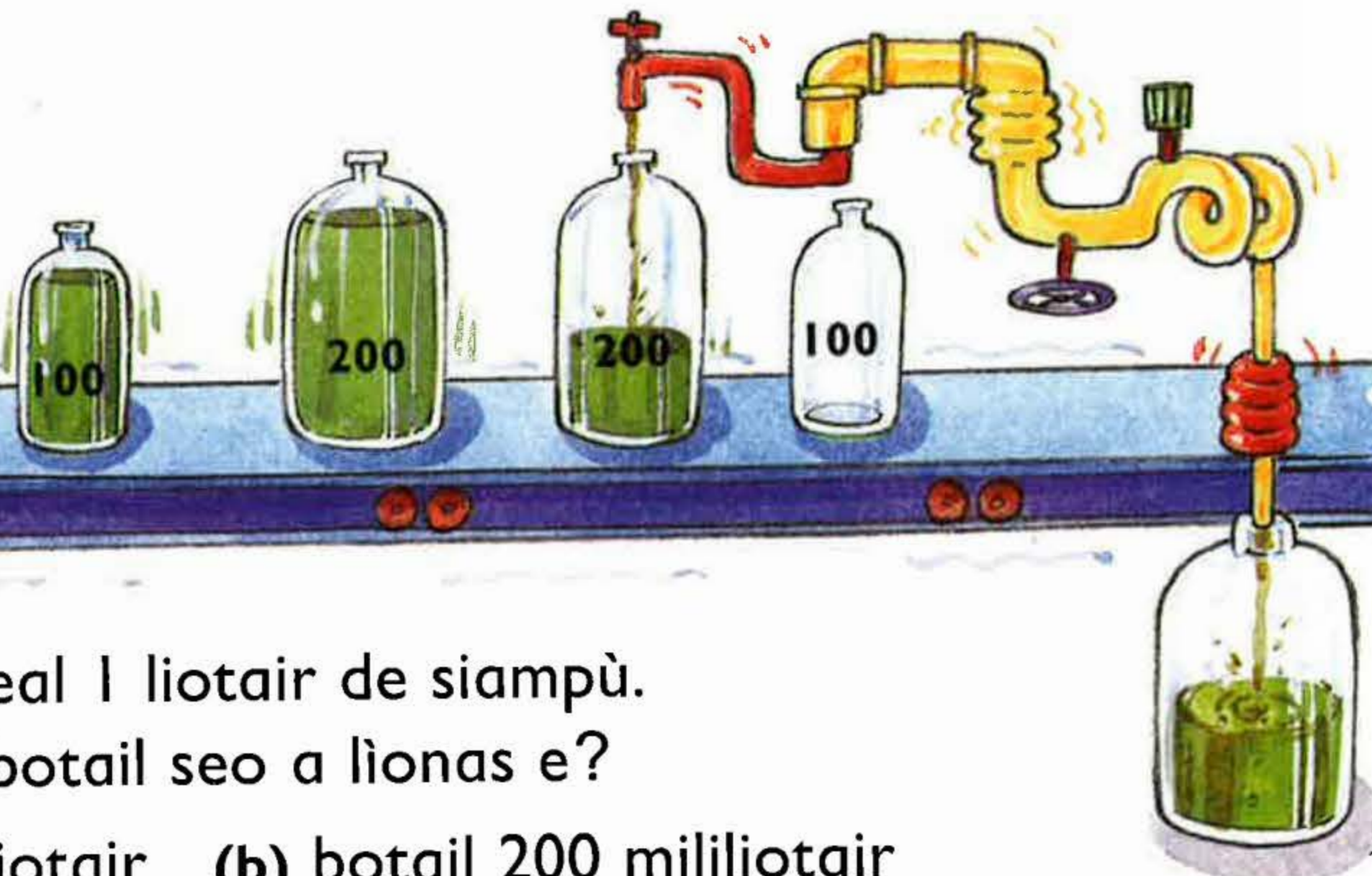
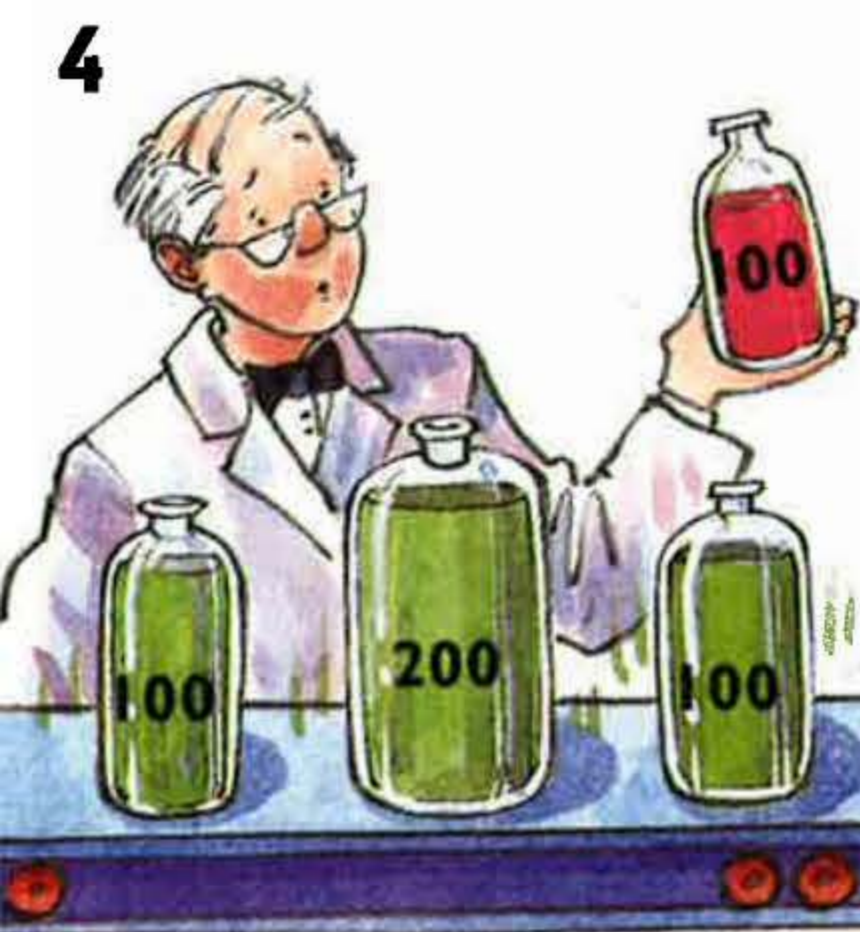

Gleidhidh an t-inneal 1 liotair de siampù.  
 Cia mheud de na botail seo a lìonas e?  
 (a) botail 100 mililiotair (b) botail 200 mililiotair

- 5 Lorg na diofar dhòighean anns an tèid botail 100 mililiotair agus 200 mililiotair an lìonadh.



Lorg gach farsaingeachd ann an ceudameatairean ceàrnagach.

M3

(a)

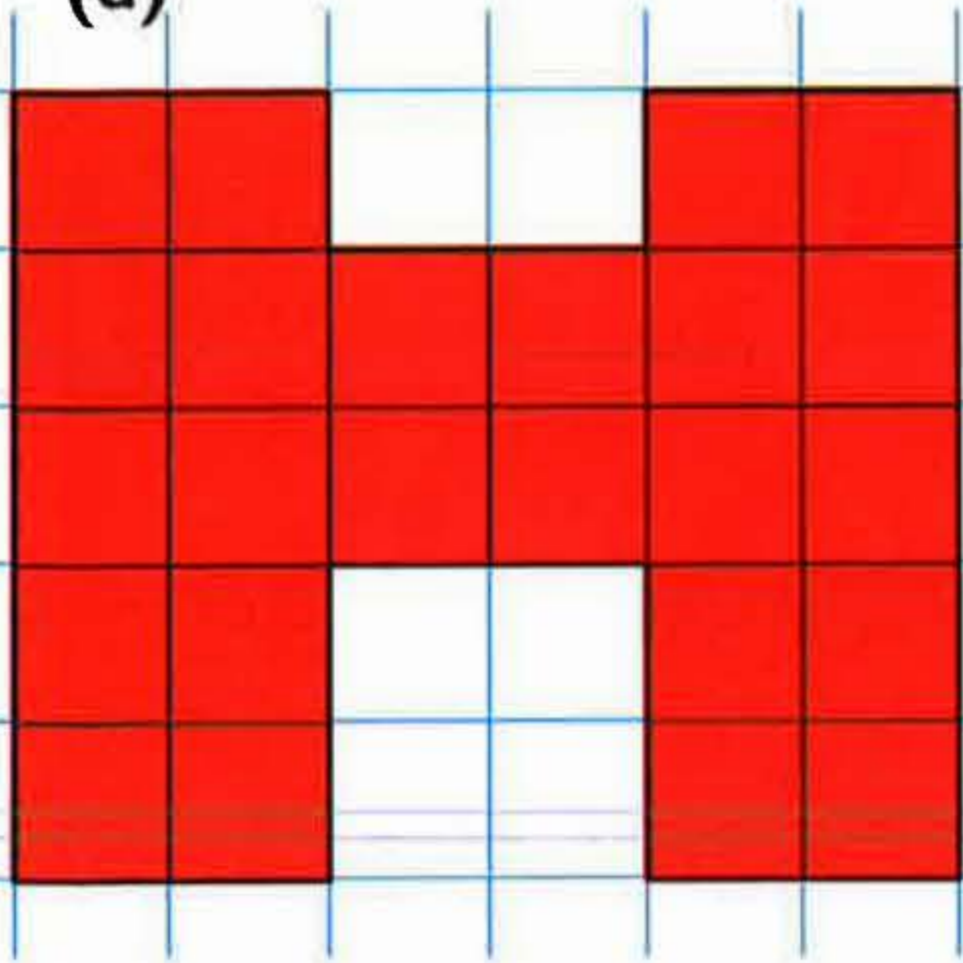

(b)

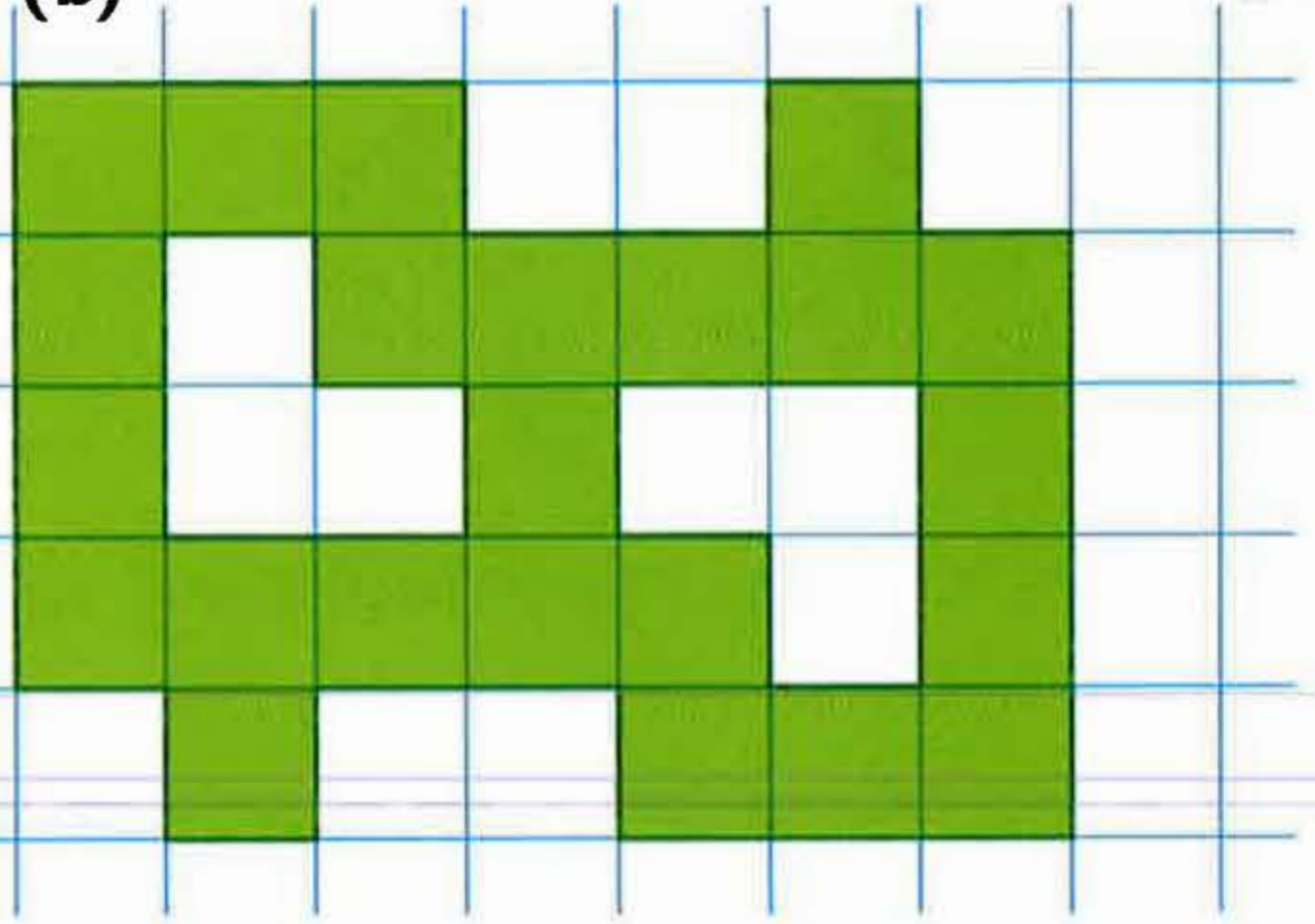

(c)

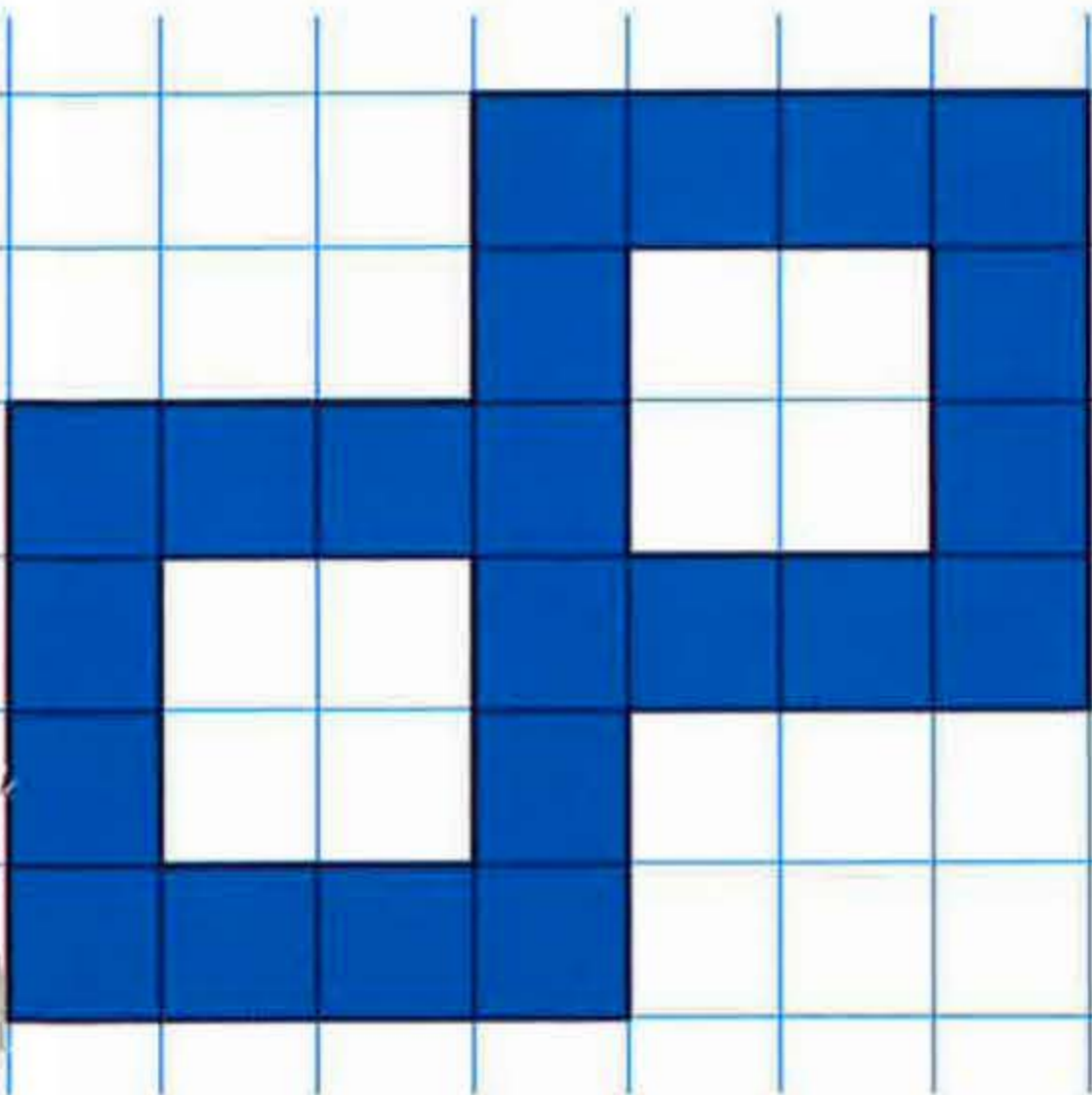

(d)

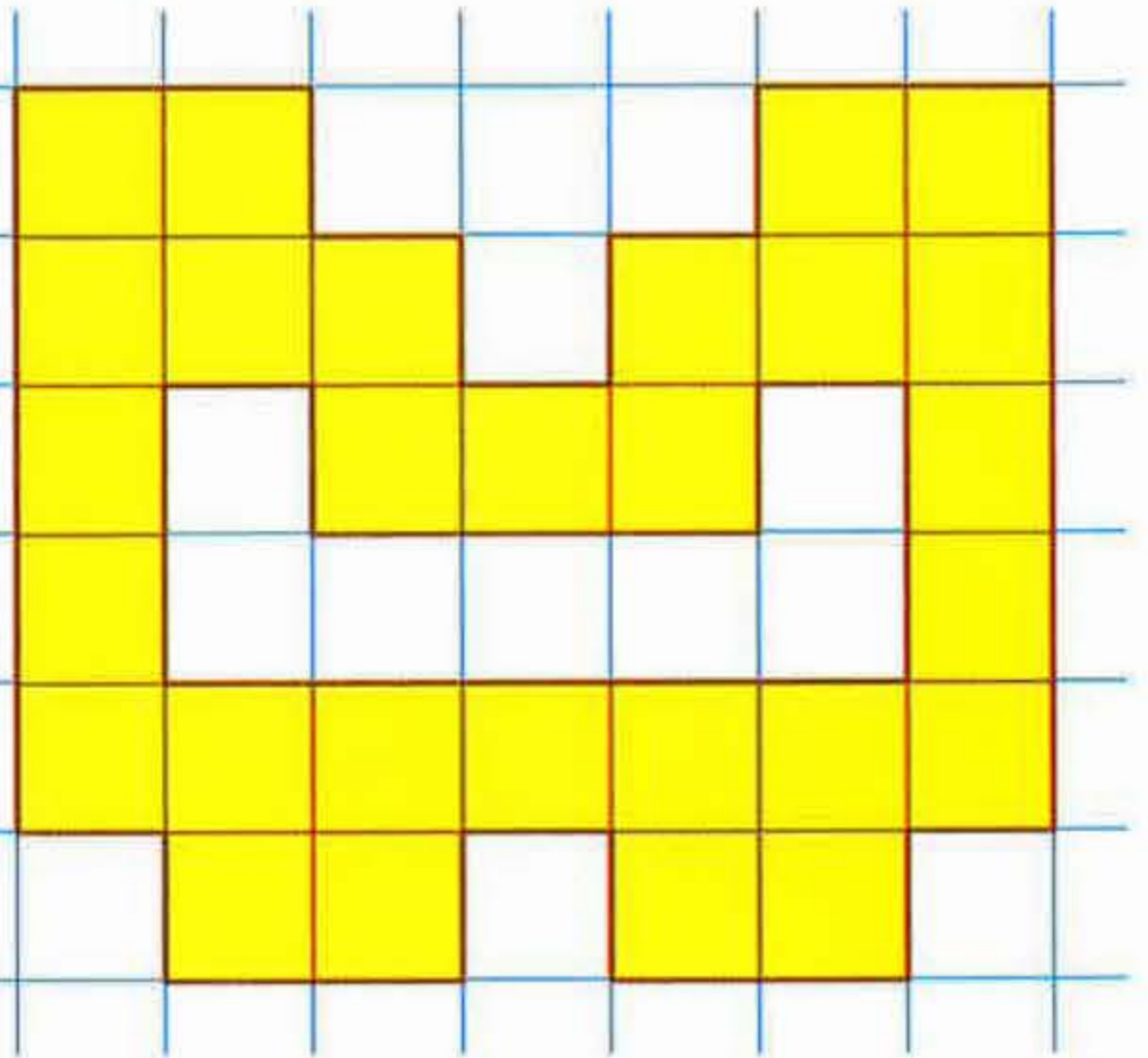

Dè an dà chruth còmhla aig a bheil farsaingeachd:

(a)  $15 \text{ cm}^2$

(b)  $18 \text{ cm}^2$

(c)  $17 \text{ cm}^2$  ?

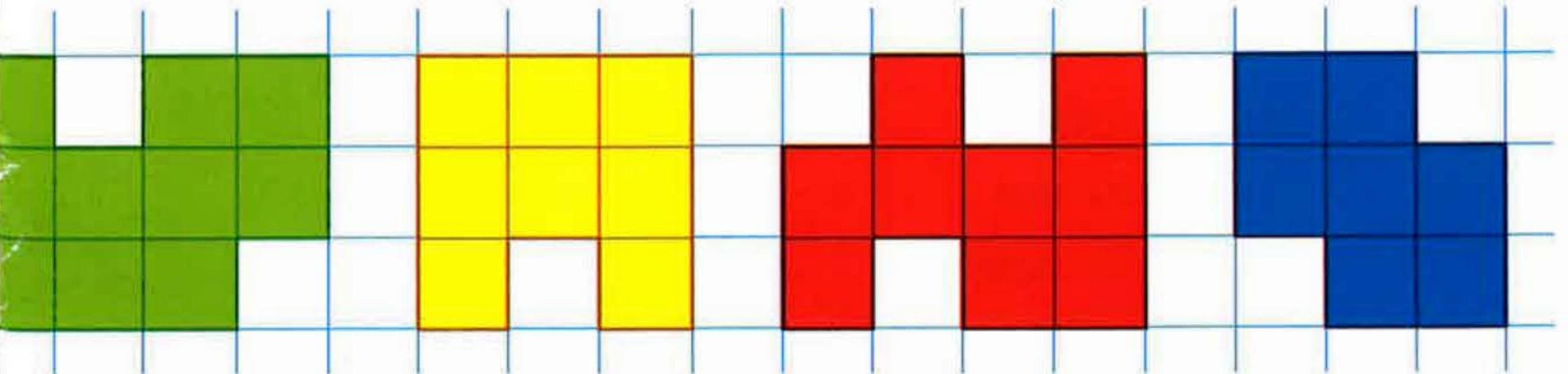

Dealbh trì ceart-cheàrnachan, gach fear le farsaingeachd  $24 \text{ cm}^2$ .



M4

Dè na cruthan aig a bheil farsaingeachd  $2\text{cm}^2$ ?

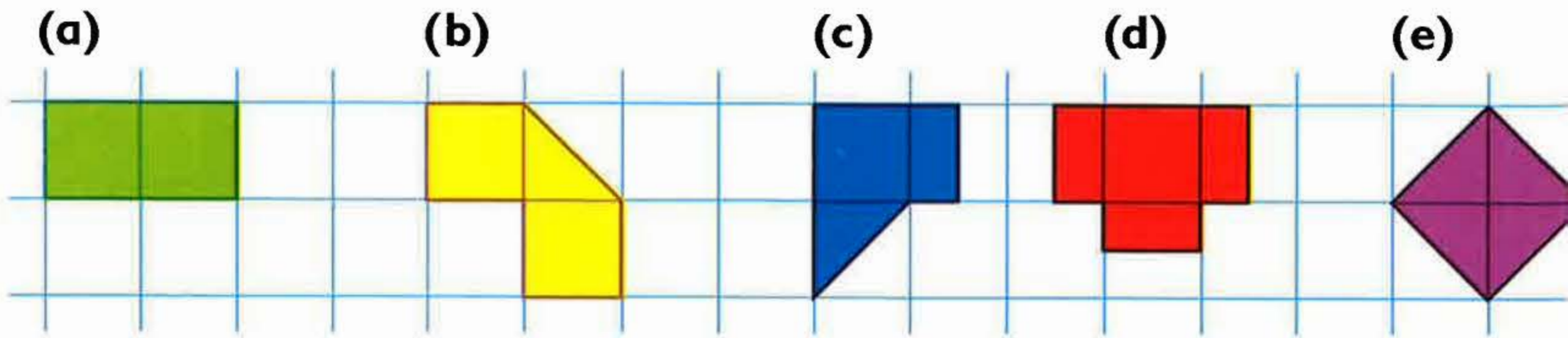

2 Lorg farsaingeachd gach cruth ann an **ceudameatairean ceàrnag**

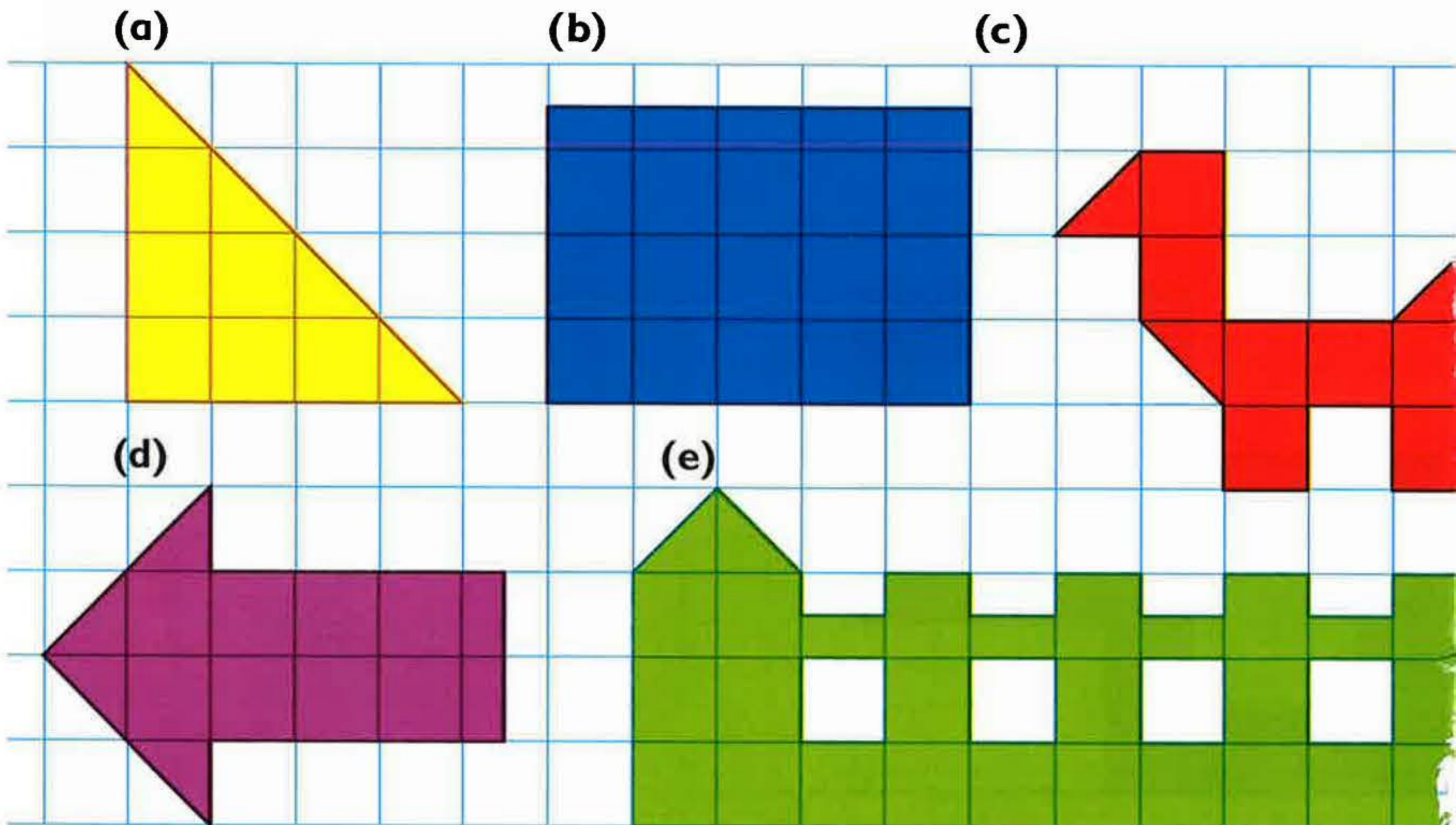

3 (a) Dealbh cruth anns a bheil farsaingeachd  $7\frac{1}{2}\text{cm}^2$ .

(b) Dealbh trì cruthan diofraichte, gach fear le farsaingeachd  $5\frac{1}{2}\text{cm}^2$

4 Lorg ceithir diofar dhòighean anns am faigheadh tu air **leth** den cheàrnaig seo a dhath.

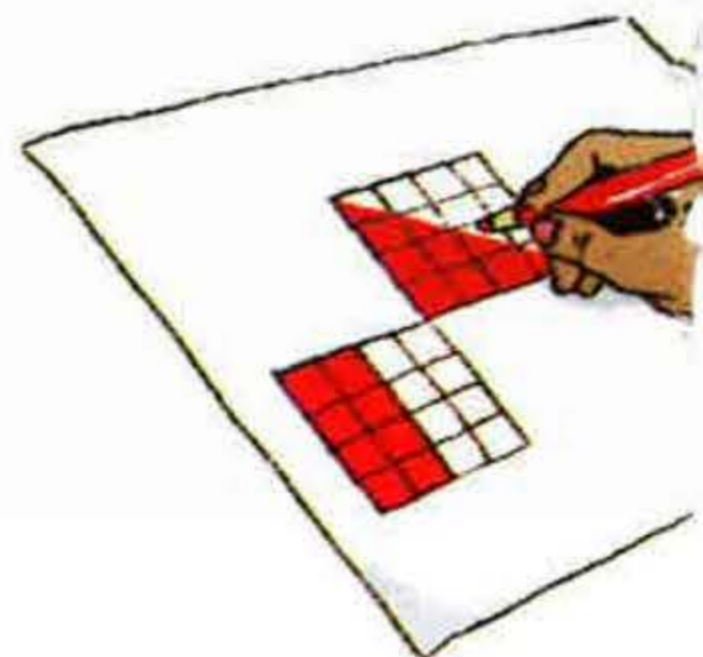
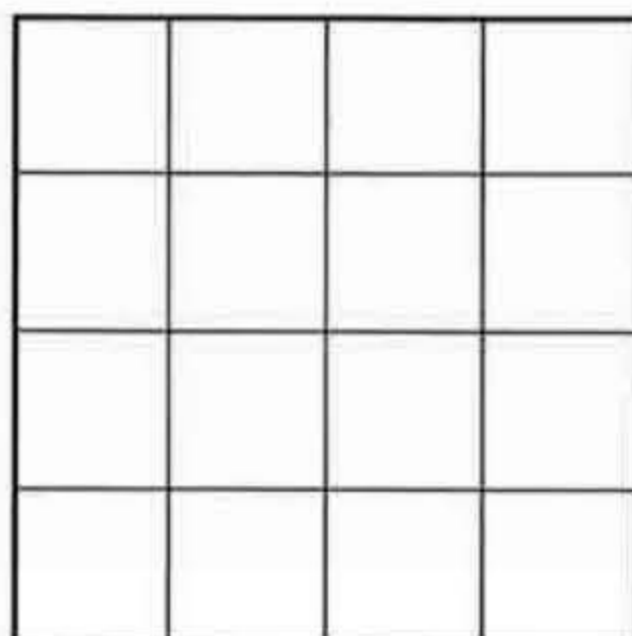





An t-Ògmhios						
Did	Dil	Dim	Dic	Diar	Dih	Dis
		1	2	3	4	5
6	7	8	9	10	11	12
13	14	15	16	17	18	19
20	21	22	23	24	25	26
27	28	29	30			

An t-Iuchar						
Did	Dil	Dim	Dic	Diar	Dih	Dis
				1	2	3
4	5	6	7	8	9	10
11	12	13	14	15	16	17
18	19	20	21	22	23	24
25	26	27	28	29	30	31

An Lùnastal						
Did	Dil	Dim	Dic	Diar	Dih	Dis
1	2	3	4	5	6	7
8	9	10	11	12	13	14
15	16	17	18	19	20	21
22	23	24	25	26	27	28
29	30	31				

### Tha Màiri a' sgrìobhadh ann an leabhar-latha.

Sgrìobh an latha den t-seachdain airson nan ceann-latha seo air an robh i a' marcachd.

- (a) 5mh den Ògmhios      (b) 20mh den Ògmhios  
 (c) 2na den Iuchar      (d) 22na den Iuchar  
 (e) 9mh den Lùnastal      (f) 1d den t-Sultain

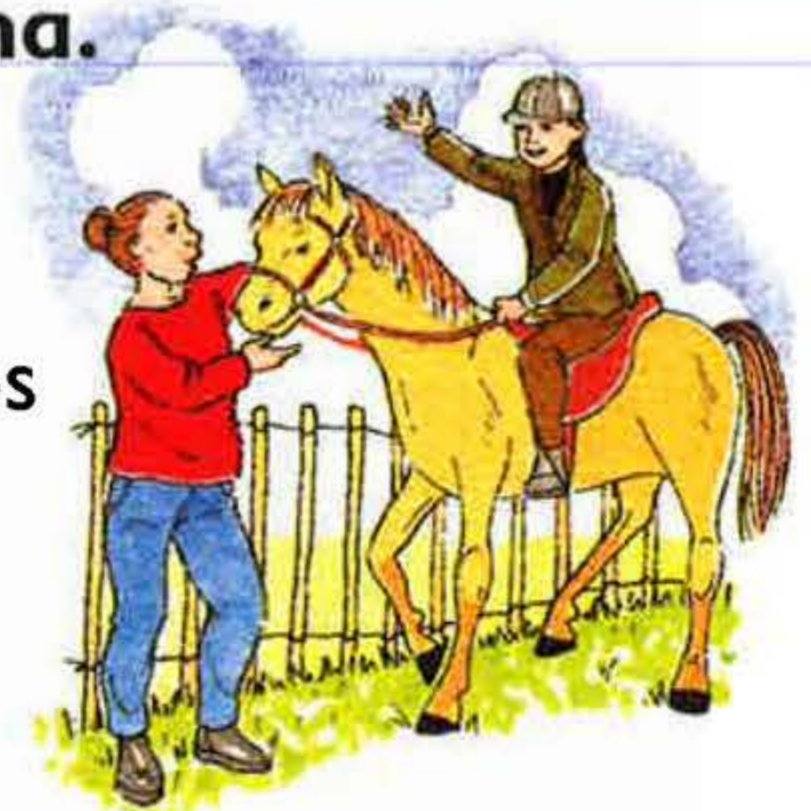

Sgrìobh an ceann-latha airson nan tachartasan seo ann an leabhar Màiri

- (a) Snàmh – an dàrna Dimàirt san Ògmhios  
 (b) A' cèilidh air Granaidh – an treas Diciadain san Iuchar  
 (c) Ceann-bliadhna – a' chiad Diardaoin san Lùnastal  
 (d) Aig an sutha – an Disathairne mu dheireadh san Lùnastal

### Leachd mìosachan airson na bliadhna-sa.

Sgrìobh latha den t-seachdain airson gach fear de na cinn-latha seo.

- (a) 15mh den Ghiblean      (b) 31mh den Chèitean  
 (c) 23mh den t-Sultain      (d) 6mh den Damhair

Sgrìobh an ceann-latha airson nan làithean seo.

- (a) A' chiad Sàbaid san t-Samhain  
 (b) An treas Diluain san Fhaoilleach



**Ti** 1 Bha Màiri air saor-làithean bhon 3mh den Iuchar chun 17mh den Iuchar. Cia mheud **seachdain** a bha i air saor-làithean?

2 Cia mheud seachdain a bha caraidean Màiri air saor-làithean?

	Anndra	Beth	Ceitidh	Daibhidh	Erica
Bho....	18mh Ògmhios	9mh Lùnastal	24mh Ògmhios	21mh Iuchar	26mh Ògmhios
Gu....	25mh Ògmhios	30mh Lùnastal	29mh Iuchar	18mh Lùnastal	7mh Lùnastal

3 Dh'fhuirich Màiri aig taigh a Granaidh bhon 25mh den Lùnastal chun 30mh den Lùnastal. Cia mheud **latha** a dh'fhuirich i ann?

4 Cia mheud latha a sheas gach tè de na fèisean seo?

(a) Siorcas:

**9mh Ògmhios –  
12na Ògmhios**



(b) Bàtaichean-siùil:

**27mh Ògmhios –  
3mh Iuchar**

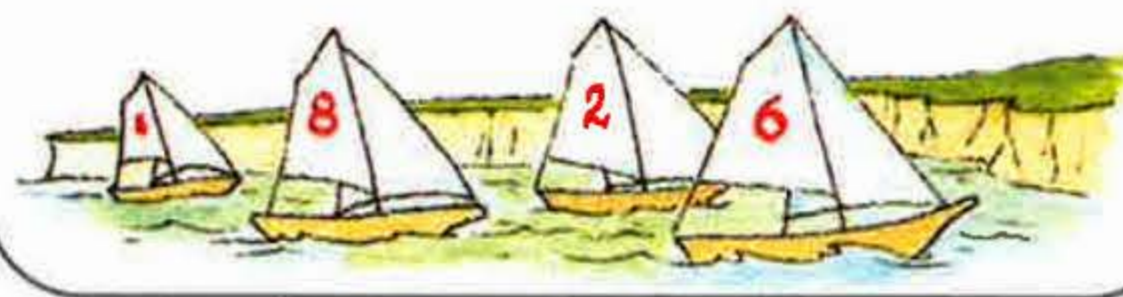

(c) Campa

**30mh Iuchar –  
8mh Lùnastal**



(d) Fèill

**26mh Ògmhios –  
28mh Lùnastal**



Cleachd mìosachan airson na bliadhna-sa.

5 Cia mheud **seachdain** a tha eadar:

(a) 25mh den Fhaoilleach chun 15mh den Ghearran

(b) 30mh den Damhair chun 11mh den Dùbhlachd?

6 Cia mheud **làtha** a tha eadar:

(a) 27mh den Mhàrt chun 5mh den Ghiblean

(b) 27mh den t-Samhain chun 25mh den Dùbhlachd?



## Ar Turas-latha le Clas 3

Tosa  
T2

Air a' bhus



8.15 m.

Àm bìdh

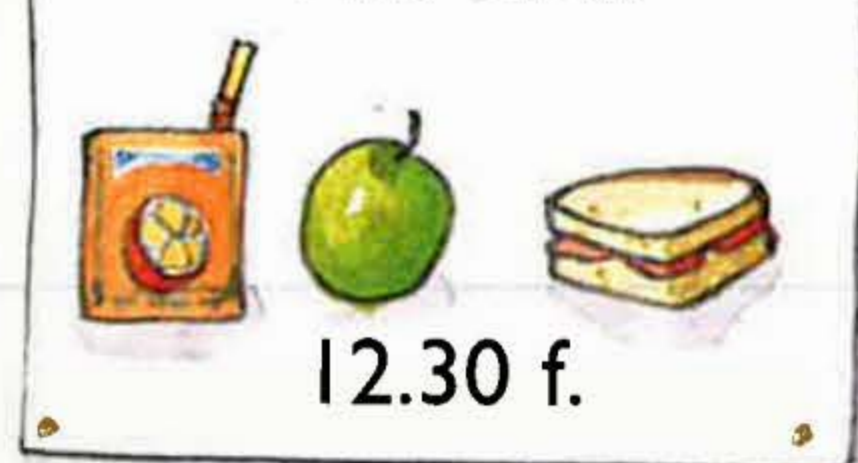

12.30 f.

Aig an loch

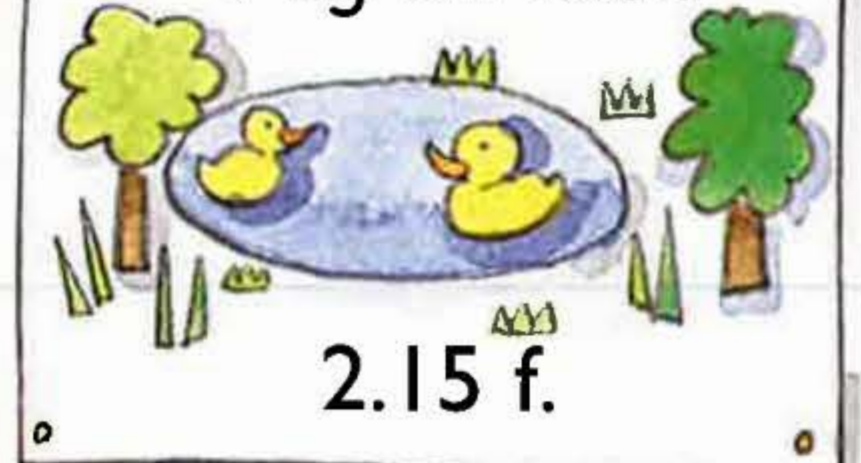

2.15 f.

Aig an tac



9.00 m.

Anns a' phàirc

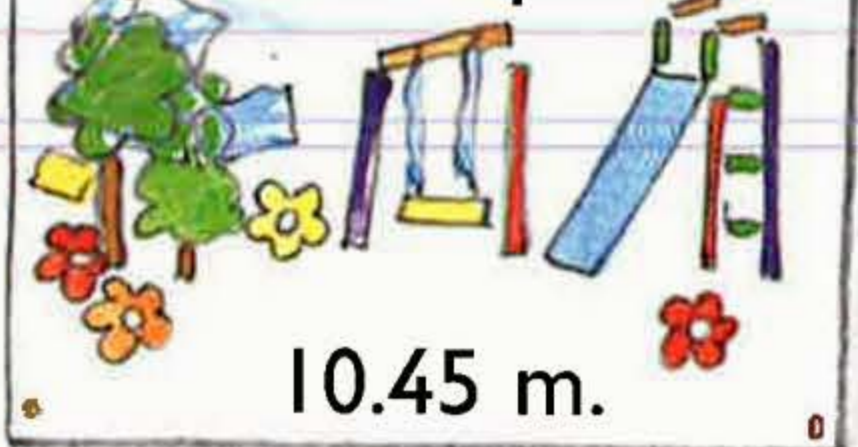

10.45 m.

Air ais dhan sgoil



3.45 f.

- 1 Càit an robh Clas 3:  
(a) ro 12 meadhan-latha (b) an dèidh 12 meadhan-latha?
- 2 Sgrìobh na h-uairean seo. Cleachd m. no f.



Cairteal an dèidh deich

(b)



Ochd uairean

(c)



Leth-uair an dèidh trì

Cairteal gu aon uair  
deug sa mhadainn

(e)

Ceithir uairean  
feasgar

- 3 Dèan dealbh de 2 rud a bhios **tusa** a' dèanamh:  
(a) ro 10.30m. (b) an dèidh 4.45f.





1 Sgrìobh na h-uairean seo.

(a)



(b)



(c)



(d)



(e)



(f)



(g) 20 mionaid an dèidh 2

(h) 25 mionaidean gu 11

(i) 10 mionaidean gu 6

(j) 5 mionaidean gu 9

(k) Cairteal gu 4

(l) 10 mionaidean an dèidh 7

2 Cuir iad seo ann an òrdugh, a' tòiseachadh leis an uair as tràithe.

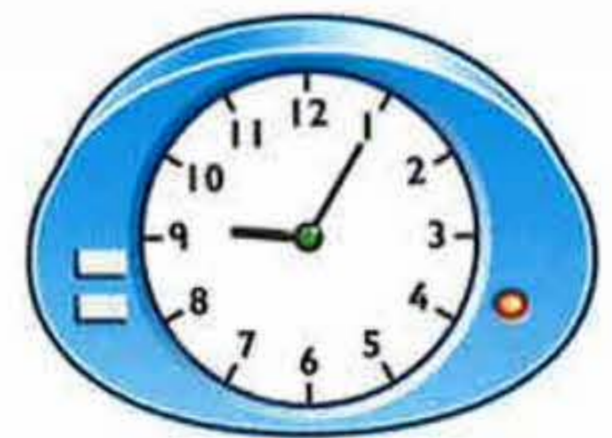

Còig mionaidean air fhichead gu ochd











Leth-uair an dèidh a h-ochd





1 Sgrìobh gach uair ann an Iatha Rut ann an **dòigh eile**.

<p>(a) </p> <p>10 mionaidean an dèidh 11</p>	<p>(b) </p> <p>1.35</p>
<p>(c) </p> <p>2.20</p>	<p>(d) </p> <p>25 mionaidean gu 3</p>
<p>(e) </p> <p>4 uairean</p>	<p>(f) </p> <p>5 mionaidean an dèidh 5</p>
<p>(g) </p> <p>10 mionaidean gu 7</p>	<p>(h) </p> <p>8.55</p>

2 Dè an dath a tha air uaireadair gach leanabh?



25 mionaidean an dèidh 4



20 mionaid gu 5

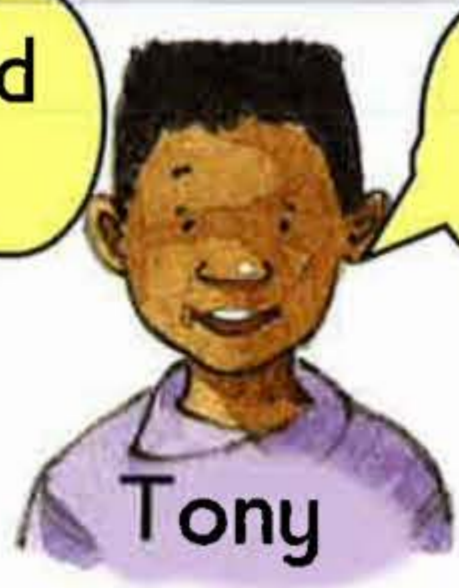

20 mionaid an dèidh 5





1 Sgrìobh gach uair. Cleachd m. no f.

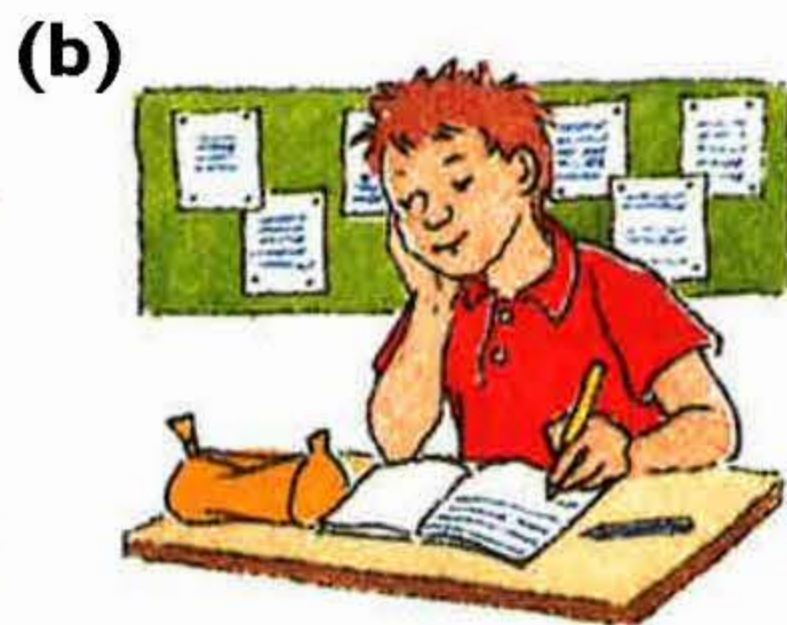

Leth-uair an dèidh dhà

Cairteal gu aon uair deug

Seachd uairean

(d) 25 mionaidean an dèidh 12 feasgar

(e) 10 mionaidean gu 9 anns a' mhadainn

(f) 5 mionaidean an dèidh 10 anns a' mhadainn

(g) 20 mionaid gu 8 feasgar

Sgrìobh iad seo ann an òrdugh.

(a) Tòisich leis an uair as tràithe anns a' mhadainn.

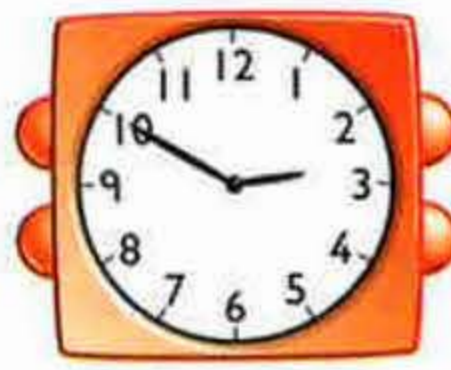

(b) Tòisich leis an uair as anmoiche feasgar.



(c) Tòisich leis an uair as tràithe.

6.15 f.

9.35 m.

5.25 m.

3.45 f.

3 Sgrìobh gach uair ann an dòigh eadar-dhealaichte.

(a) 15 mionaidean gu 8 anns a' mhadainn (b) 1.40 m.

(c) 20 mionaid an dèidh 12 air an oidhche (d) 5.15 f.



<i>Turas-baidhsagal Sìne</i>		
<i>Ceum</i>	<i>uair</i>	<i>àite</i>
<i>A</i>	<i>10.25 m.</i>	<i>a' fàgail na dachaigh</i>
<i>B</i>	<i>10.45 m.</i>	<i>tarsainn air an drochaid</i>
<i>C</i>	<i>10.50 m.</i>	<i>seachad air an sgoil</i>
<i>D</i>	<i>11.15 m.</i>	<i>steach don phàirc</i>
<i>E</i>	<i>11.45 m.</i>	<i>a' fàgail na pàirce</i>
<i>F</i>	<i>12.25 m.</i>	<i>a' tilleadh dhachaigh</i>

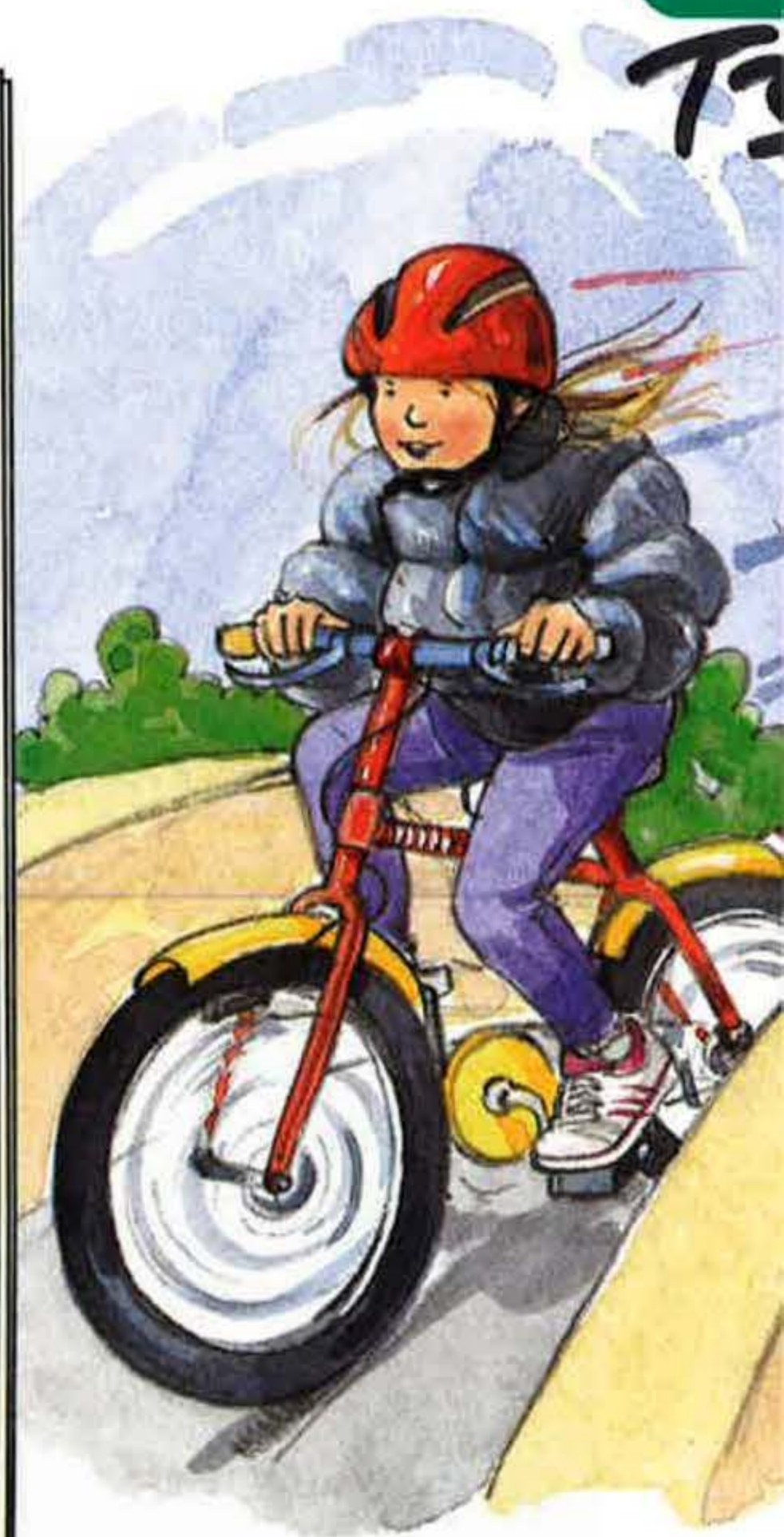

- 1 Cia mheud mionaid a tha eadar gach ceum ann an leabhar-fiosrachaidh Sìne?
- 2 Dè cho fada an dèidh dhi a dachaigh fhàgail a chaidh i seachad air an sgoil?
- 3 Dè an ùine an dèidh dhi a dhol tarsainn air an drochaid a chaidh i a-steach don phàirc?
- 4 Dè cho fada 's a thug turas-baidhsagal Sìne gu lèir?
- 5 Càit an robh Sìne aig na h-uairean seo anns a' mhadainn?

(a)



(b)







1 Dh'fhàg Matt an taigh aig 8.25 m.  
Tha an turas chun na sgoile a' toirt 25 mionaidean.  
Dè an uair aig an do ràinig e an sgoil?



2 Tha an clas Maths a' tòiseachadh aig 9.20 m.  
Tha e a' crìochnachadh aig 10.00 m.  
Dè an ùine a tha iad anns a' chlas?



3 Tha iad a' faighinn a-mach airson 20 mionaid.  
Tha an tràth seo a' crìochnachadh aig 10.50 m.  
Dè an uair aig a bheil e a' tòiseachadh?



4 Crìochnaich clàr-ama Mhatt le bhith a' lìonadh a-steach nam beàrnan.

Gnìomh	A' tòiseachadh aig	A' seasamh airson	A' crìochnachadh aig
Àm-bìdh	12.45 f.	45 mionaidean	(a)
Leughadh	1.40 f.	(b)	2.10 f.
Ealan	(c)	40 mionaid	3.20 f.

5 Tha an sgoil a' crìochnachadh aig 3.30 f.  
Tha clas-snàimh Matt a' tòiseachadh 2 uair a thìde an dèidh sin.  
Tha an clas a' seasamh airson 35 mionaidean.  
Dè an uair aig a bheil an clas a' crìochnachadh?

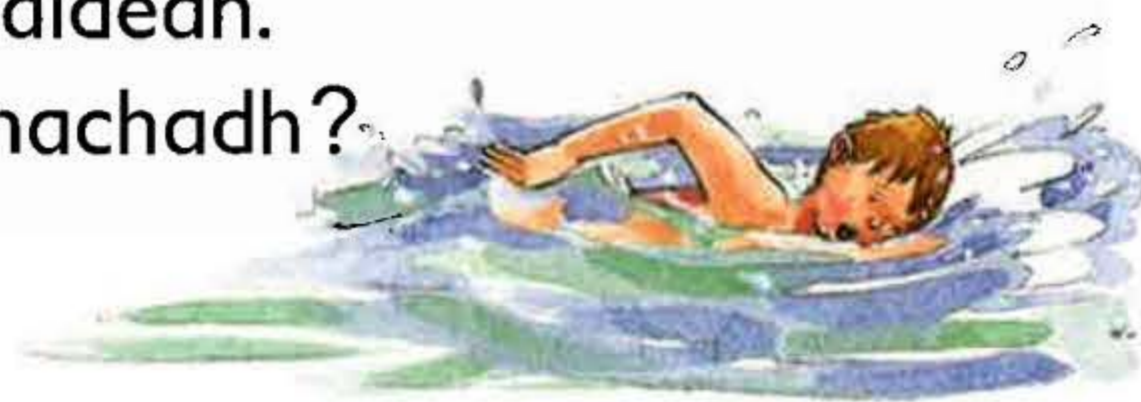



## Feumaidh tu cruthan 3sh mar iad seo.

1 Maids gach cruth ris an ainm aige.

(a)



(b)



(c)



(d)



(e)



(f)



(g)



(h)

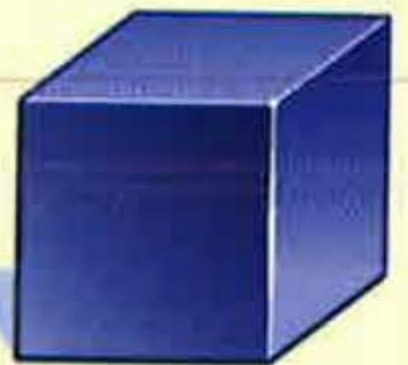

cruinne

priosam triantanach

ciùb

còn

ciùbaid

leth-chruinne

pioramaid

siolandair

2 Ainmich na cruthan 3sh anns a' mhodail seo.



3 (a) Tog fhèin modail le cruthan 3sh.  
(b) Ainmich na cruthan a chleachd thu.

4 Dè an cruth 3sh air a bheil na daoine seo a' bruidhinn?

(a)



Tha dà aodann rèidh air, agus aon aodann lùbte.

(b)

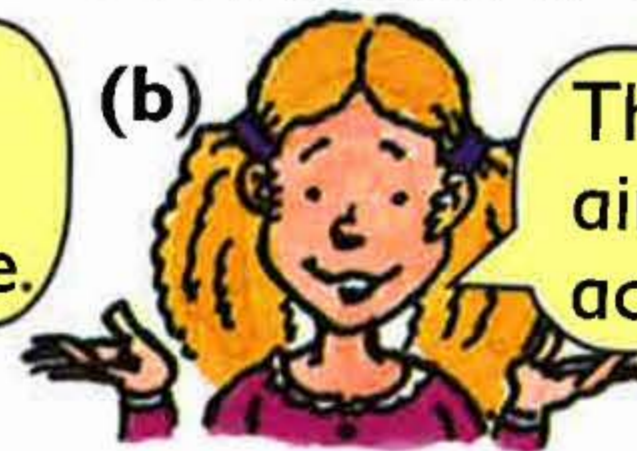

Tha aon aodann lùbte air, agus chan eil aodann rèidh idir air.

(c)



Tha aon aodann lùbte air, agus aon aodann rèidh. **Chan e cònn a tha ann.**





1 Cia mheud gob a tha air gach cruth?  
**ciùbaid → 8 goban**

2 Dè an cruth air a bheil 1 ghob?

3 Dè na cruthan air a bheil:  
 (a) 6 goban                      (b) 0 goban  
 (c) na h-aon àireamhan de ghoban?

4 (a) Cunnt agus sgrìobh àireamh nan oirean **dìreach** airson gach cruth.  
**ciùbaid → 12 oir**

(b) Dè na cruthan air a bheil na h-aon àireamhan de dh'oirean dìreach?

5 Dè na cruthan air a bheil oirean lùbte?

6 Seall ri na paidhrichean de chruthan seo.

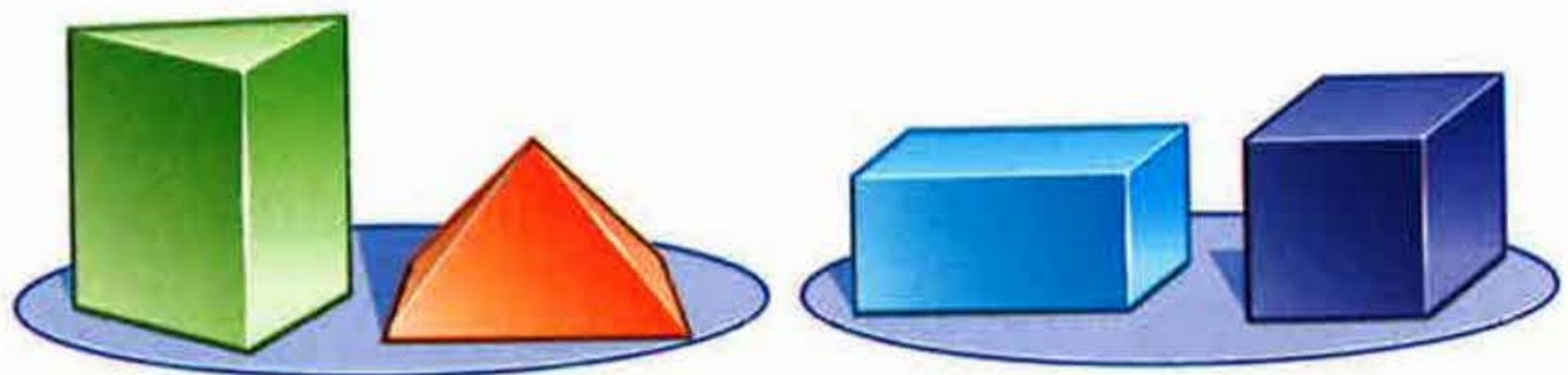

(a) Dè a tha **co-ionnan** mu na cruthan anns gach paidhir?  
 (b) Dè a tha eadar-dhealaichte mun deidhinn?

7 Sgrìobh abairtean a bheireadh beachd do dhuine mun chruth seo.





- I Cleachd cruthan flat airson na cruthan seo a thogail:
- (a) ciùb
  - (b) ciùbaid
  - (c) prìosam triantanach
  - (d) pioramaid le bonn ceàrnagach.

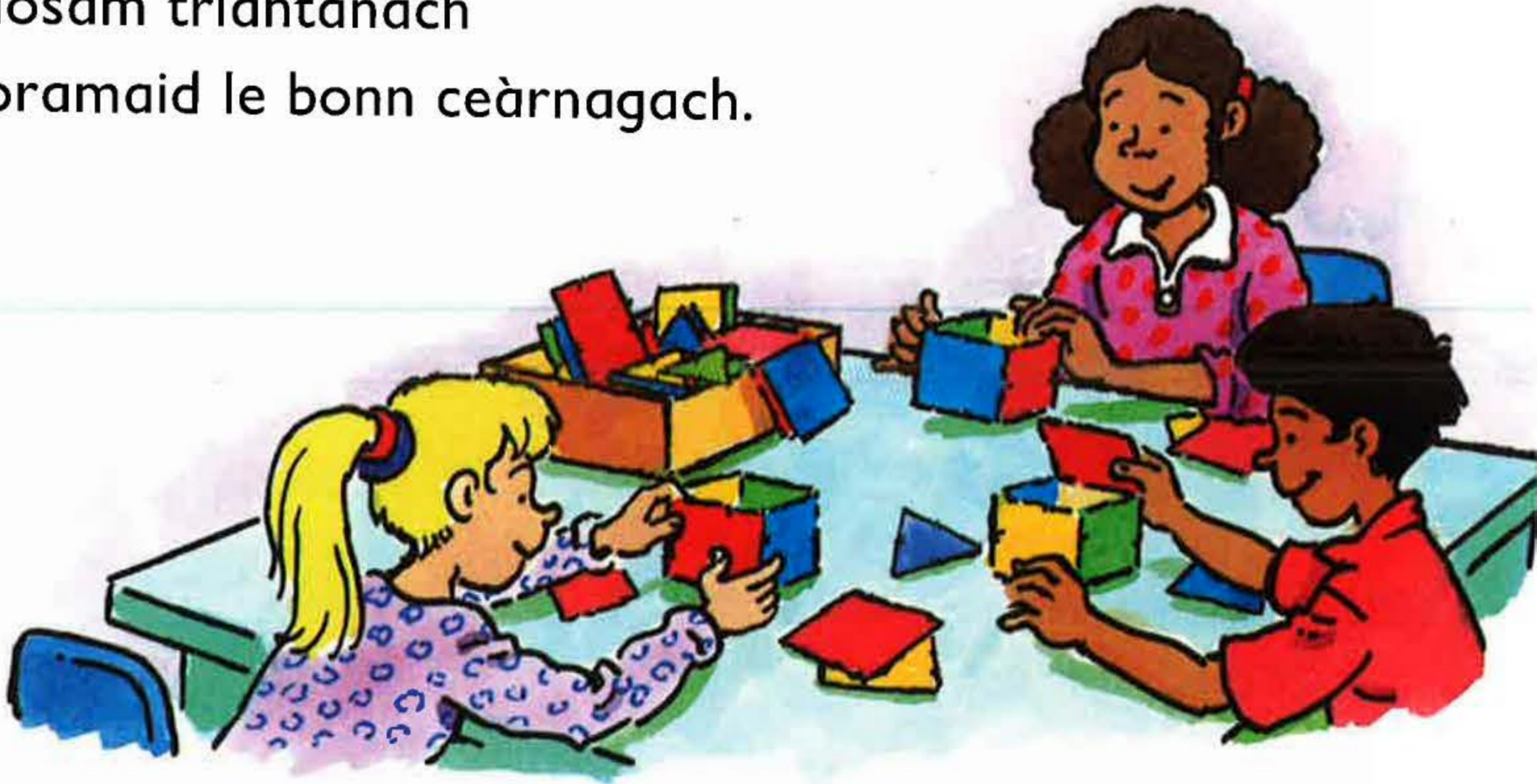

- 2 Cleachd sràbhan agus ceanglaichean gus iad seo a thogail:
- (a) ciùb
  - (b) ciùbaid
  - (c) pioramaid le bonn triantanach
  - (d) prìosam triantanach
  - (e) ciùbaid

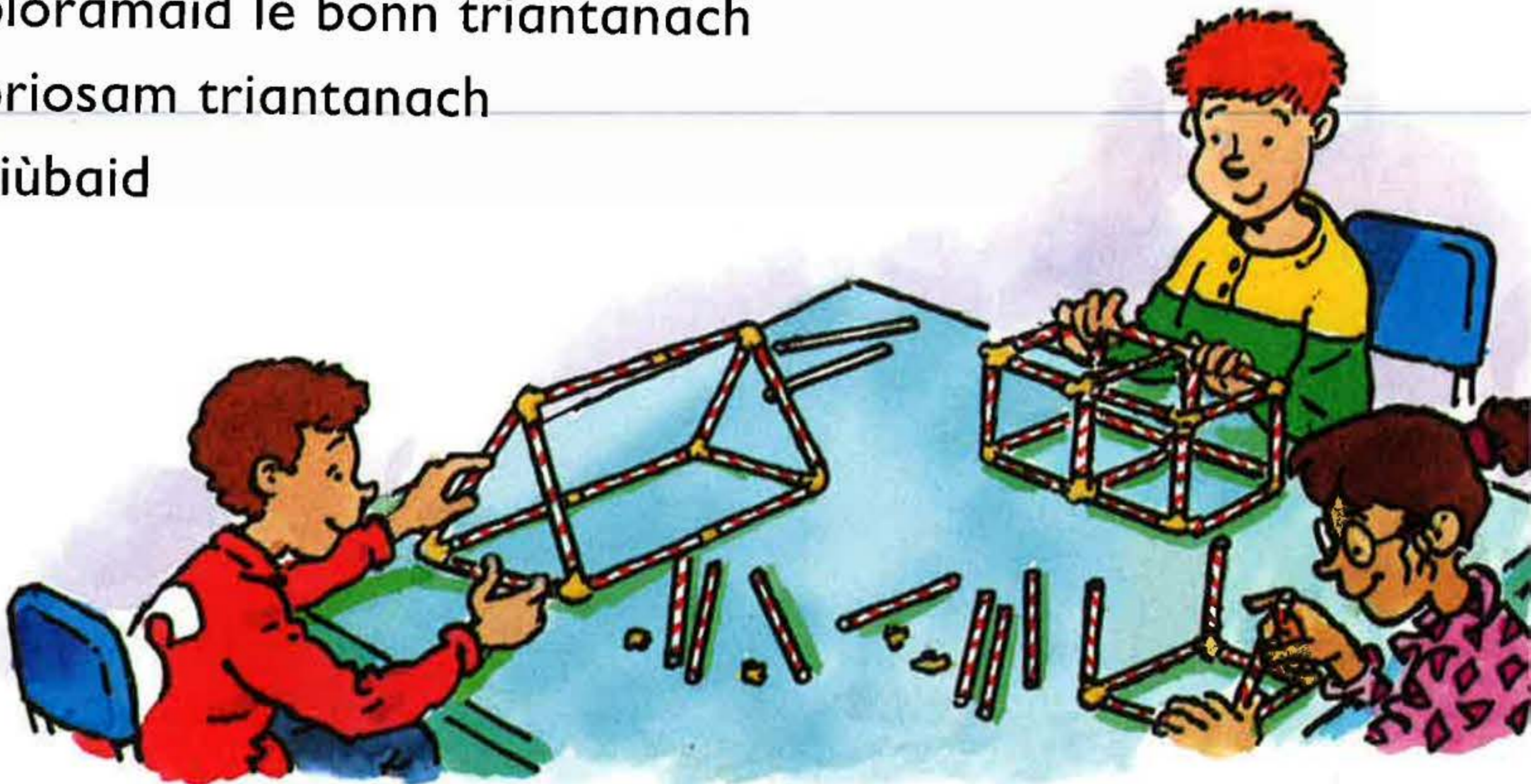



## Cleachd ciùban ceangail.

1 Tog na cruthan seo.

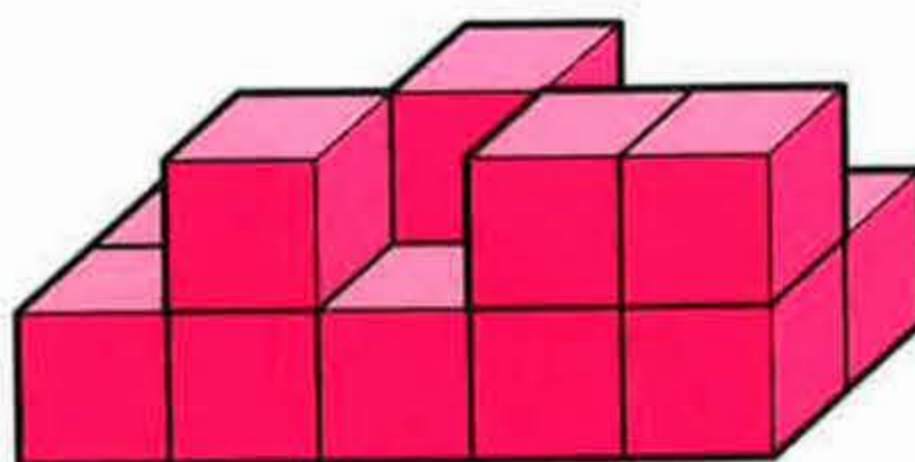
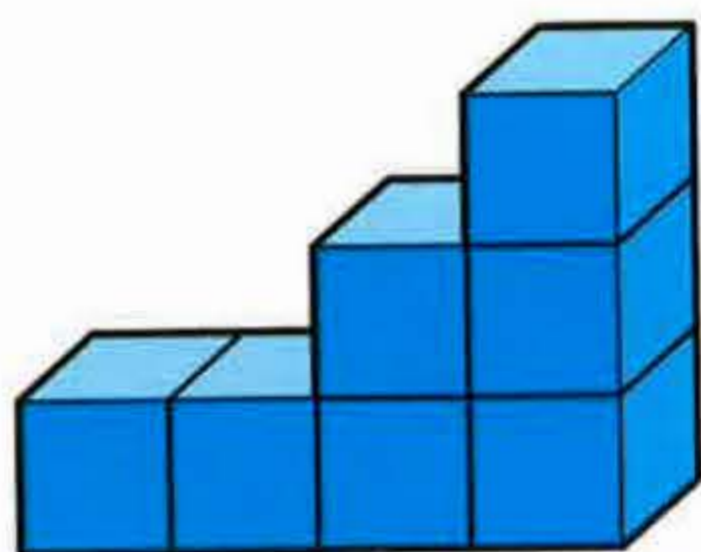
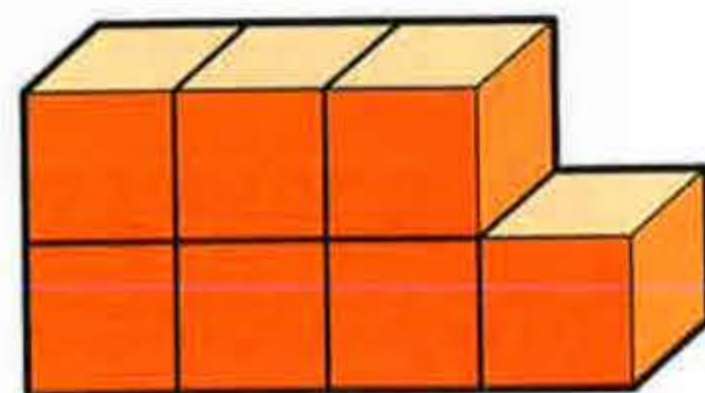
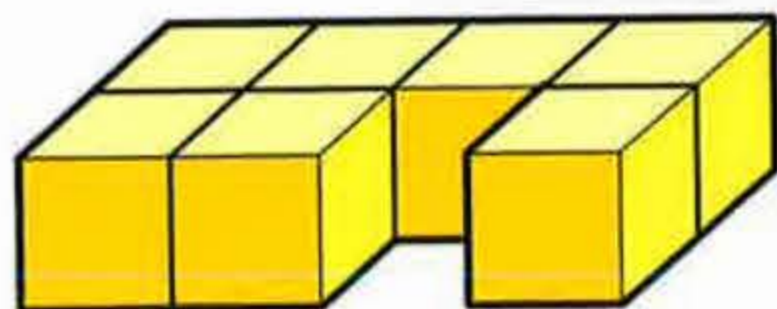
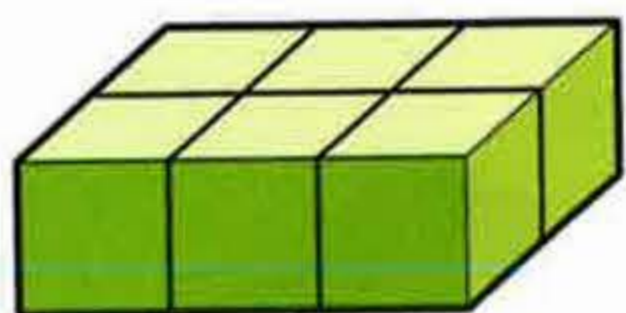

- 2 (a) Cia mheud ciùb a tha thu a' **smaoineachadh** a chaidh a chleachdadh gus na cruthan seo a thogail?  
(b) Dèan cinnteach le bhith a' togail gach cruth.

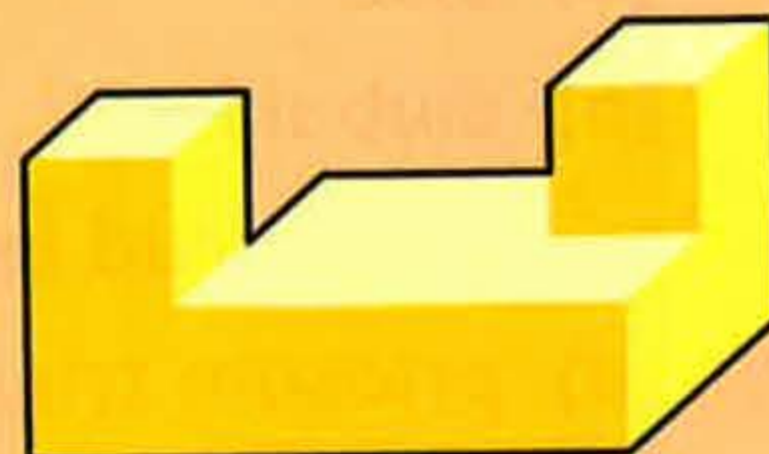
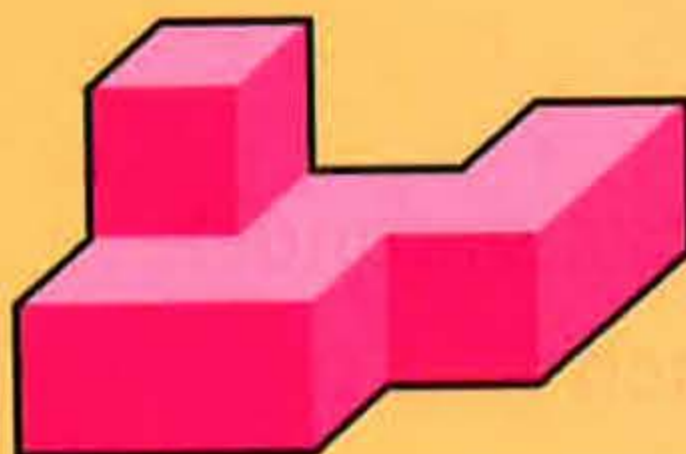
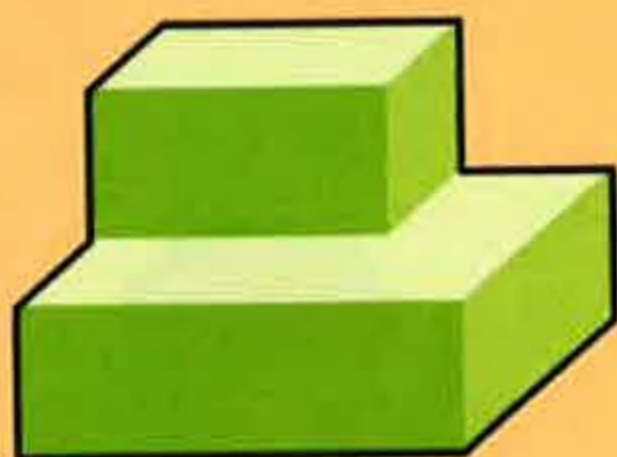
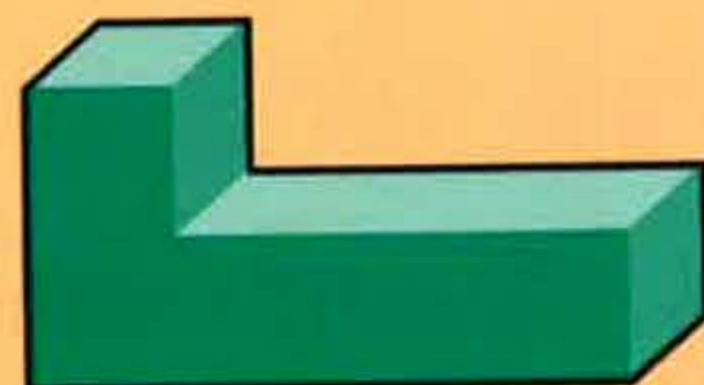
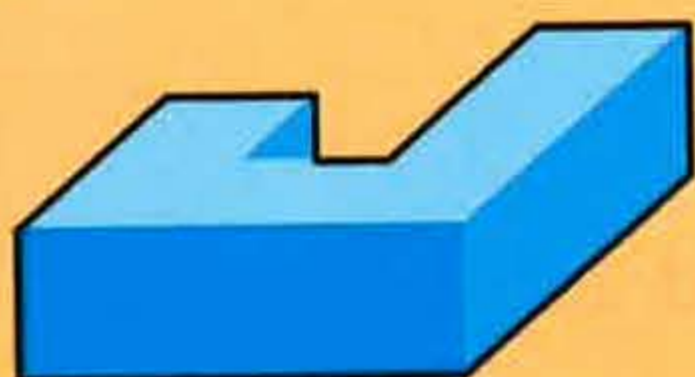

- 3 Tog nas urrainn dhut de chiùbaidean **eadar-dhealaichte** le:

- (a) 12 chiùb  
(b) 24 ciùban.

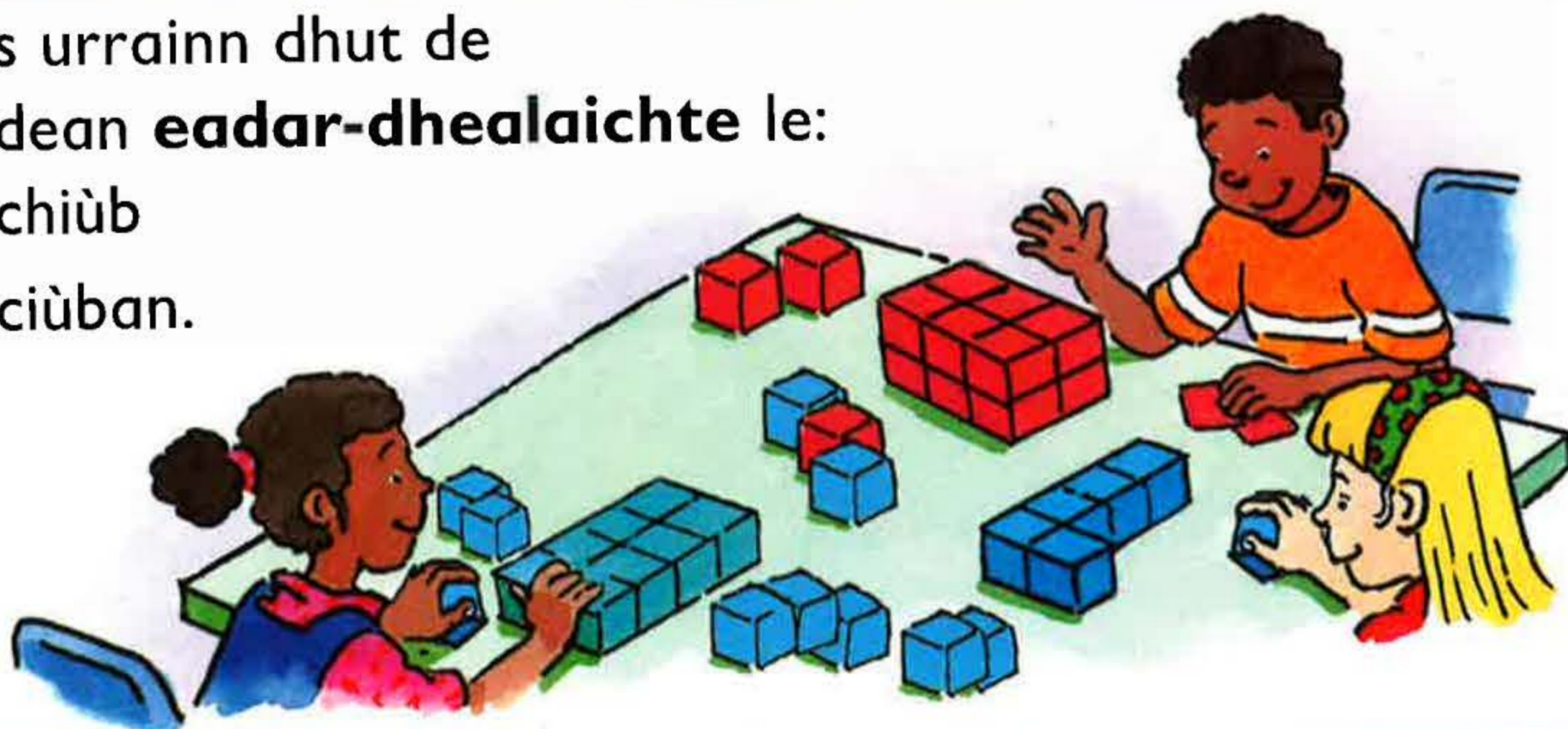



- 1 Dè an fheadhainn de na cruthan dathach a tha:  
(a) nan ceithir-cheàrnachan (b) nan triantain  
(c) cunbhalach (d) air a bheil ceàrn ceart  
(e) air a bheil nas lugha na ceithir ceàrnan  
(f) air a bheil barrachd air sia taobhan?

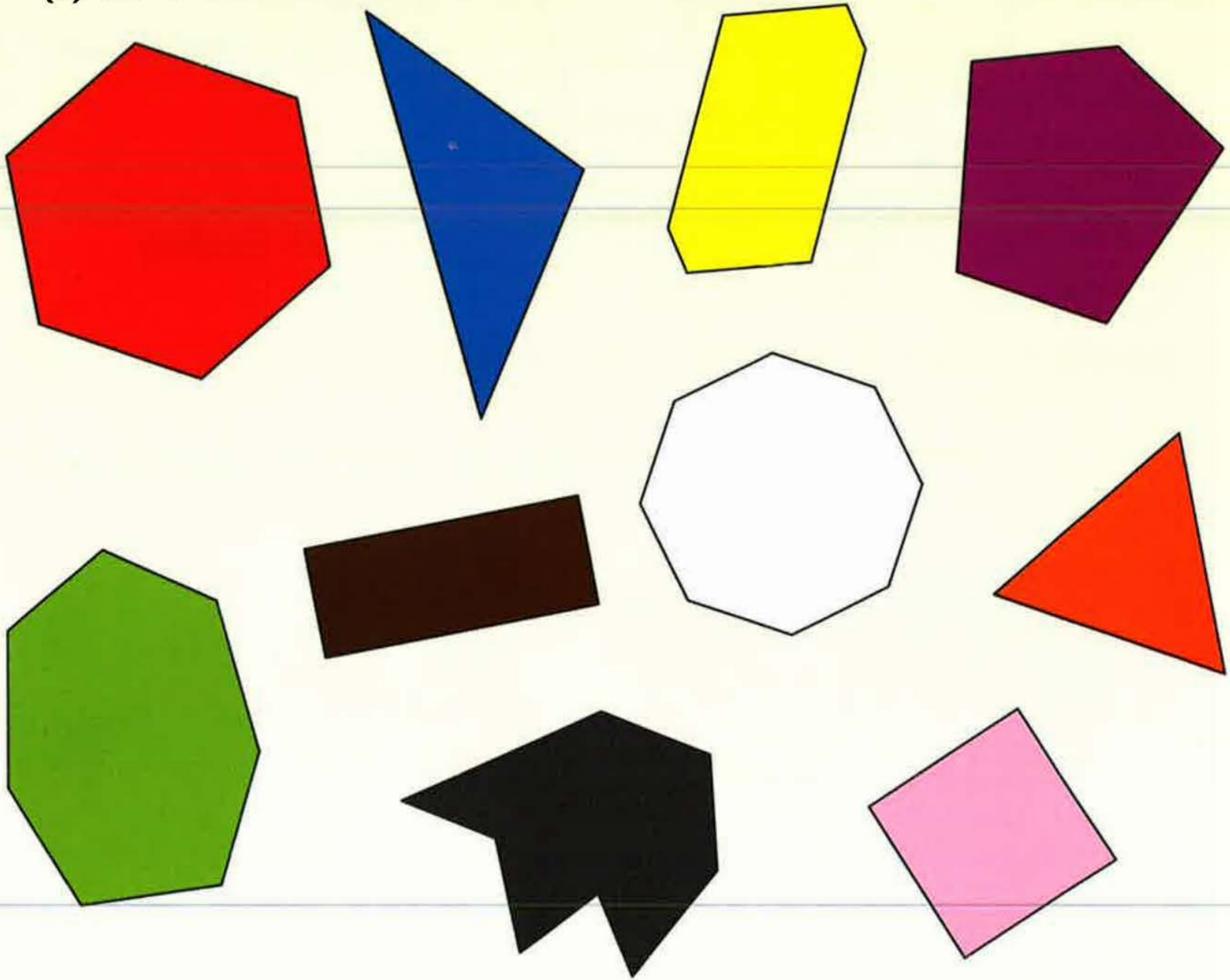

- 2 Dè an dath a tha air:  
(a) a' cheart-cheàrnach (b) an t-sia-cheàrnach **chunbhalach**  
(c) an ochd-cheàrnach **chunbhalach**  
(d) an ochd-cheàrnach **neo-chunbhalach**?
- 3 Sgrìobh ainm a' chruth air a bheil dath:  
(a) purpaidh (b) buidhe (c) orains.



1 Cleachd dà thriantan airson na cruthan seo a dhèanamh.

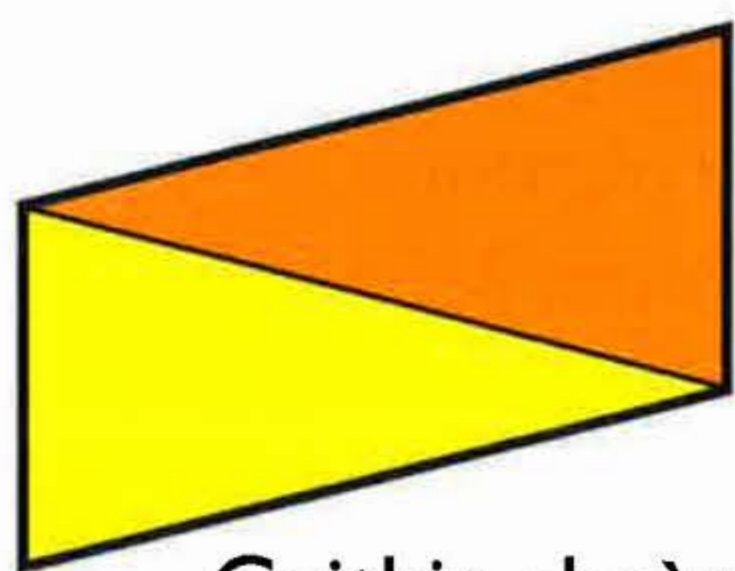

Ceithir-cheàrnach

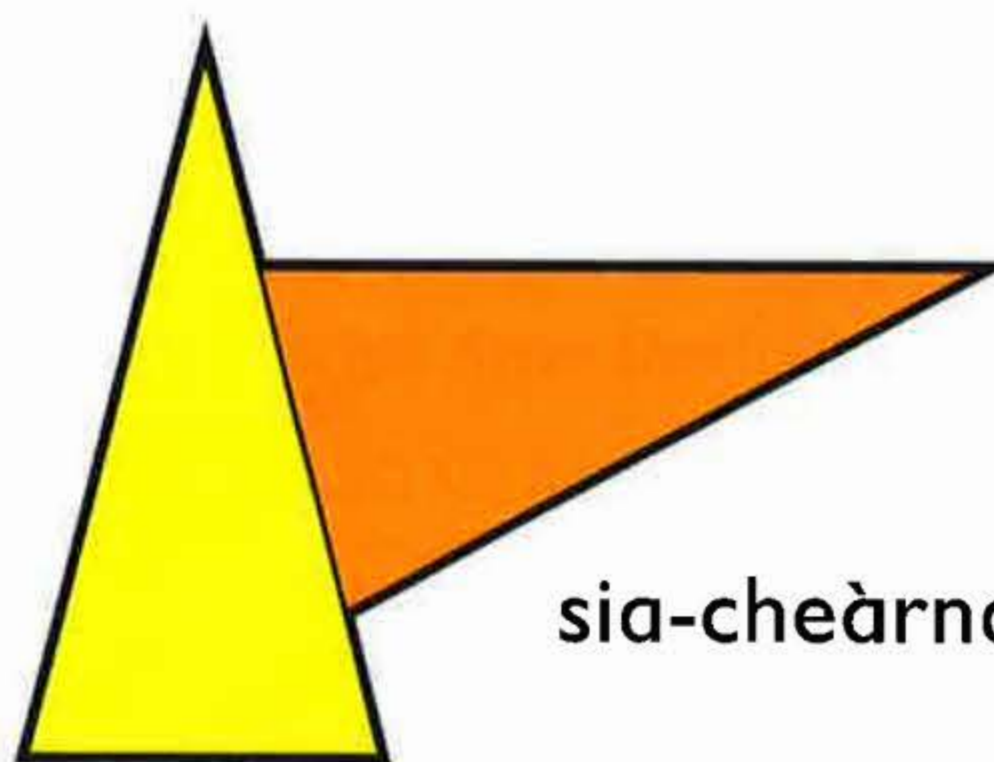

sia-cheàrnach

2 Cleachd an dà thriantan. Dèan agus an uair sin dealbh:

(a) còig-cheàrnach (b) sia-cheàrnach eile

(c) dà cheithir-cheàrnach eadar-dhealaichte.

3 Cleachd pàipear spotach. Ath-dhealbh agus crìochnaich gach pàtran de thriantain.

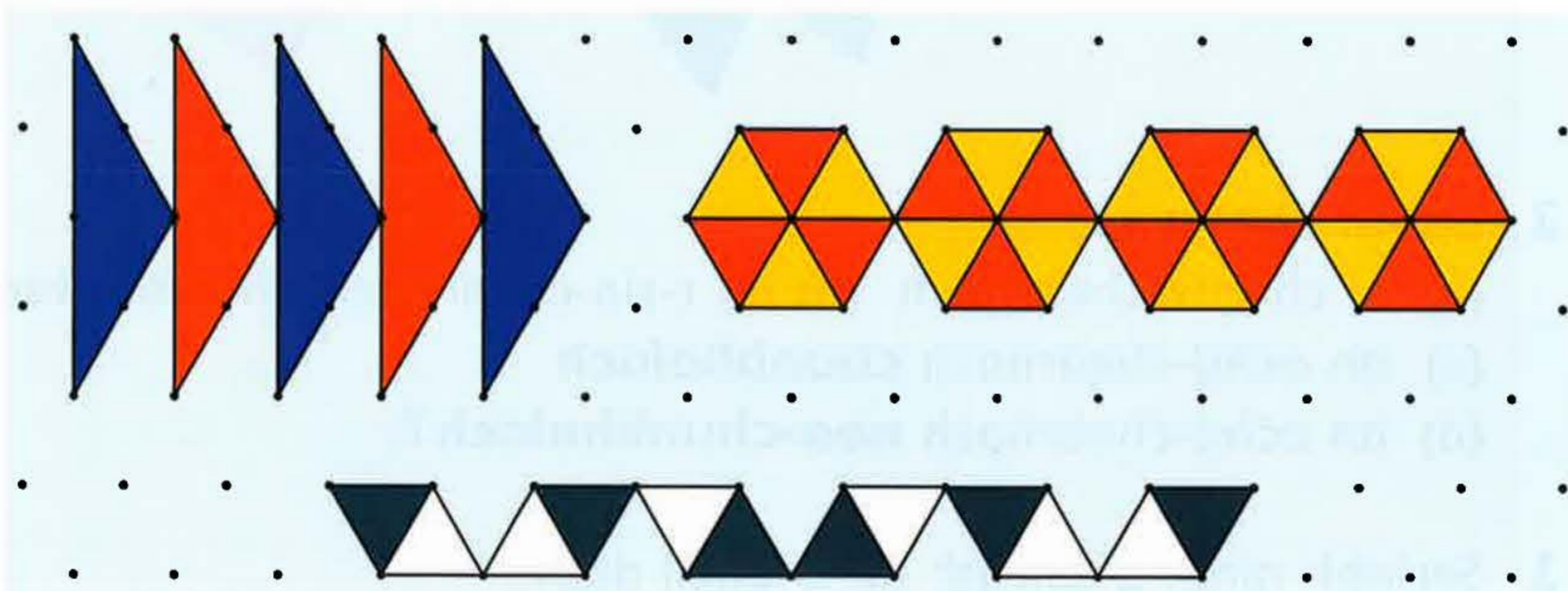
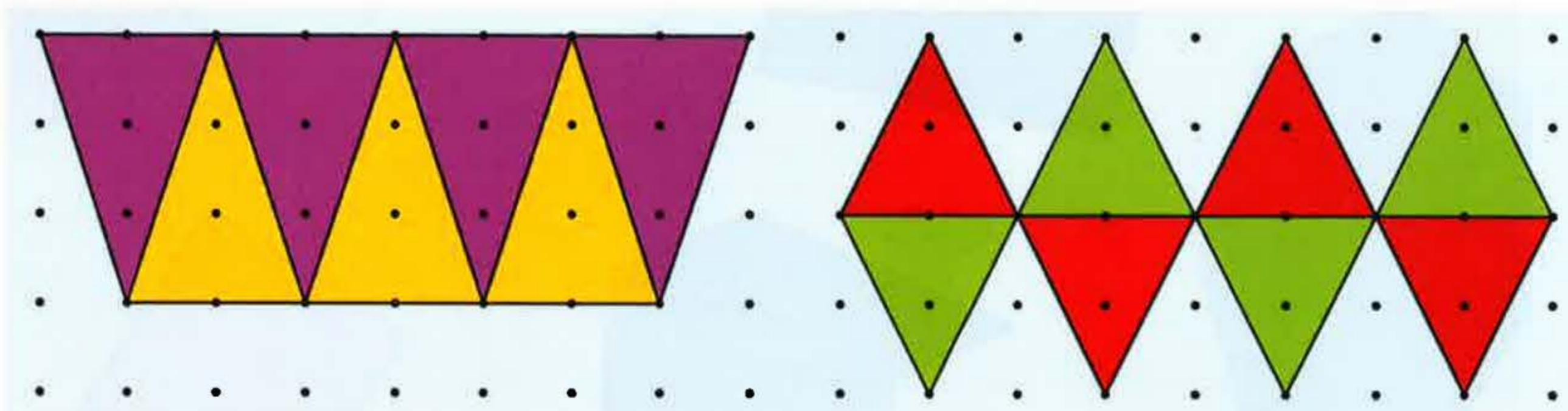



1 Cia mheud loidhne cothromachaidh a tha anns gach **cruth**?

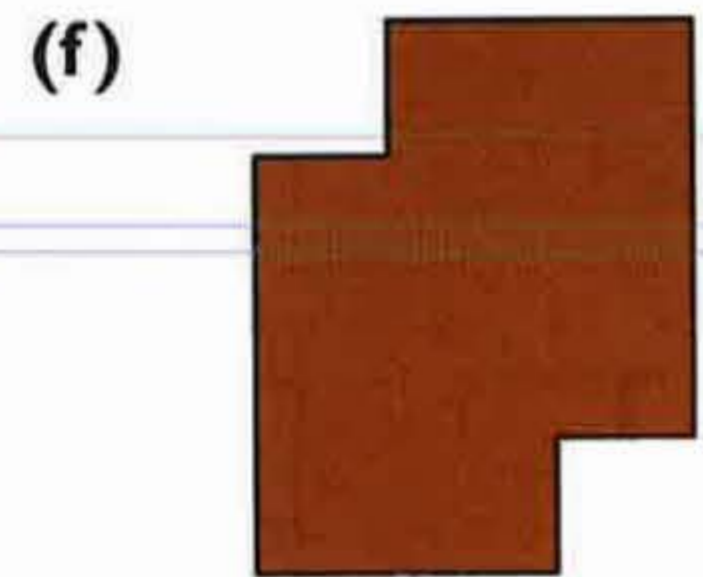
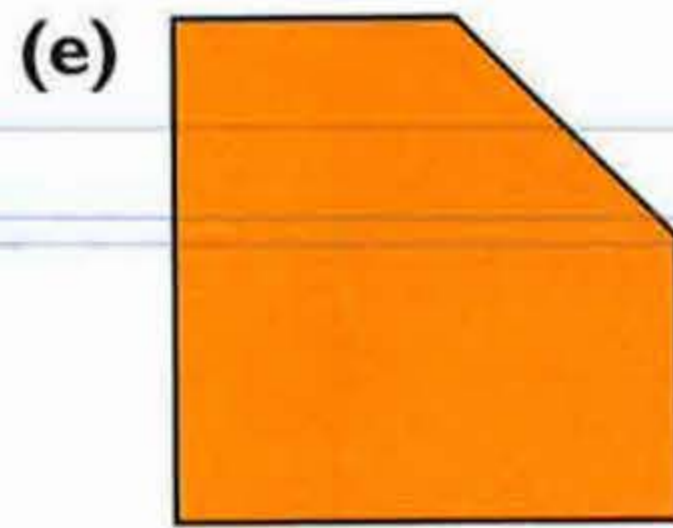
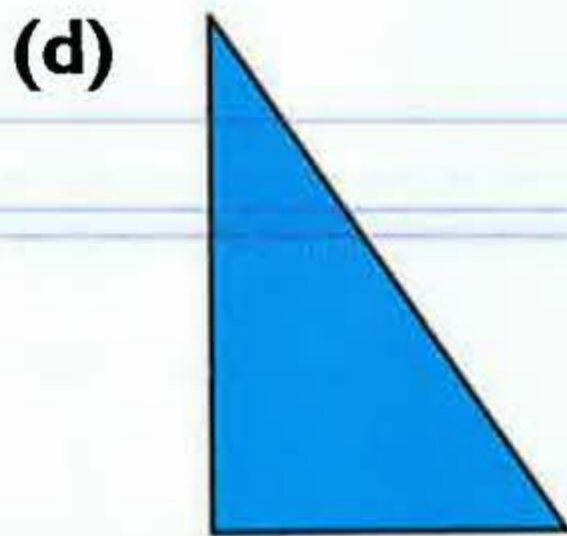
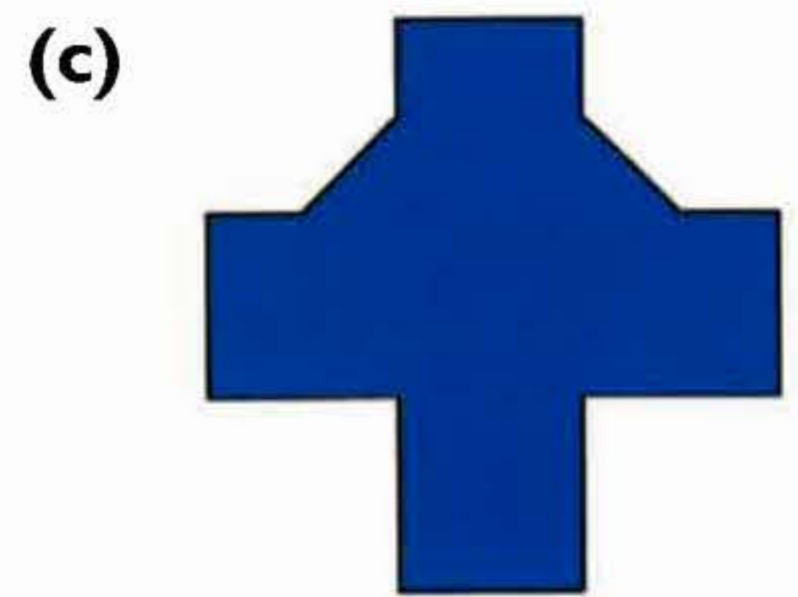
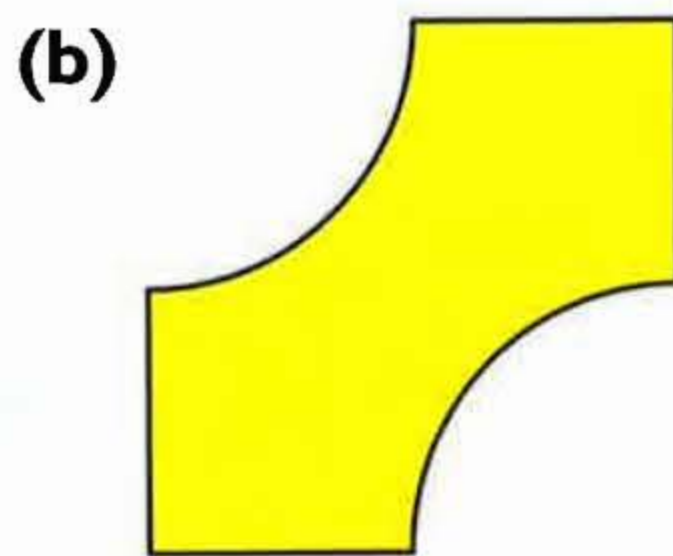
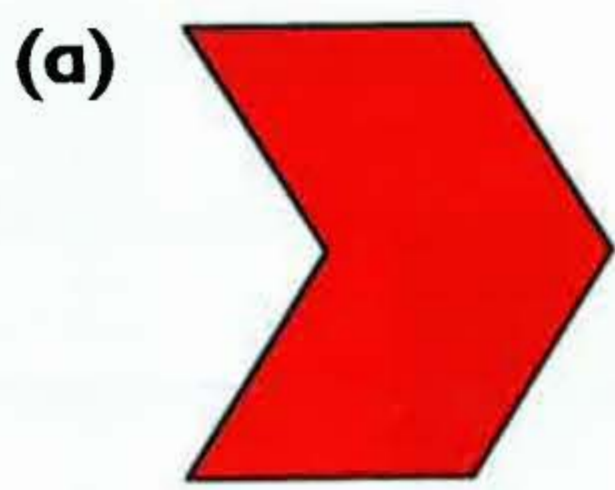

2 Dèan sgeidse de chruth le **dìreach**:

(a) aon loidhne cothromachaidh (b) dà loidhne cothromachaidh.

3 Cia mheud loidhne cothromachaidh a tha anns gach **pàtran**?

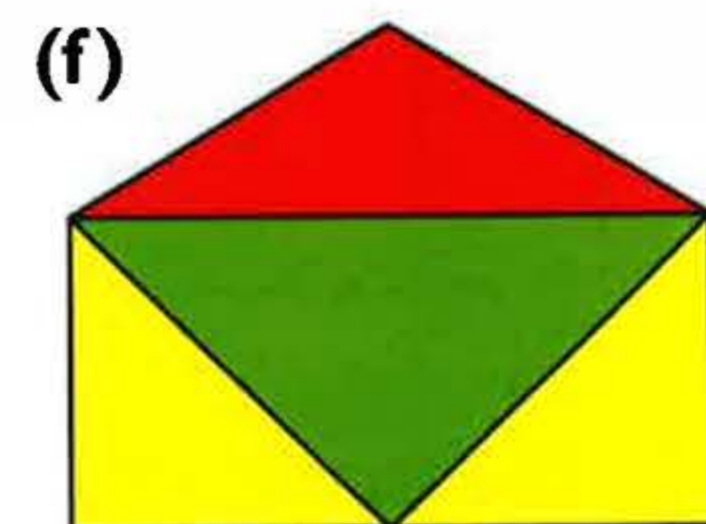
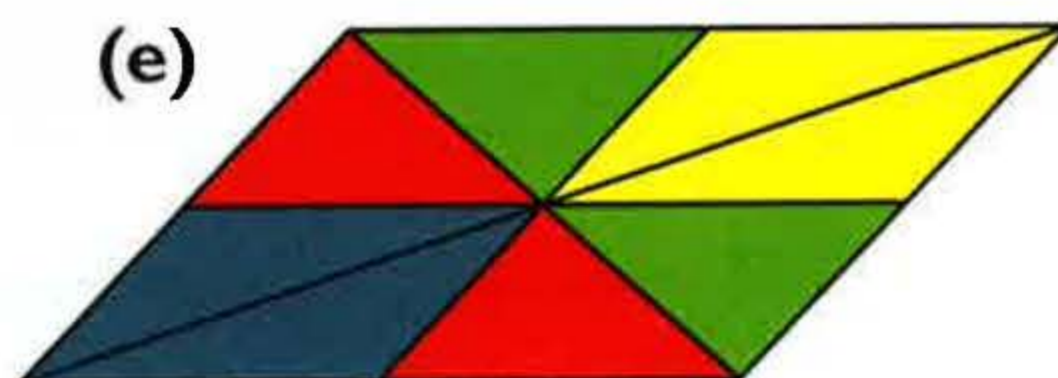
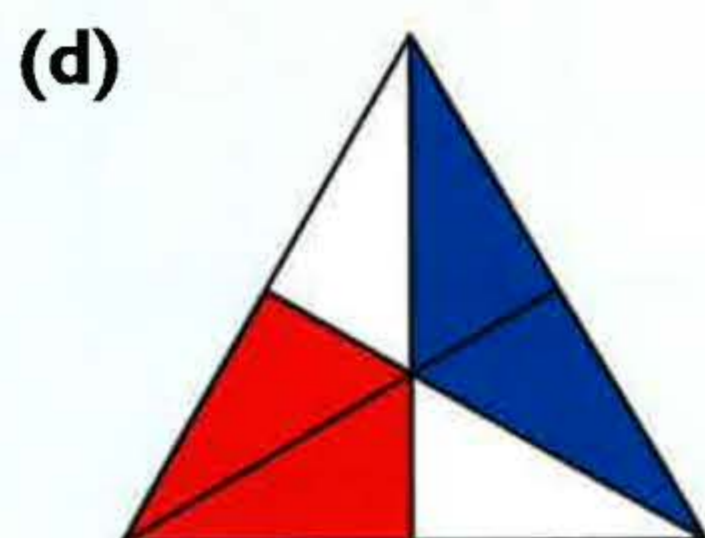
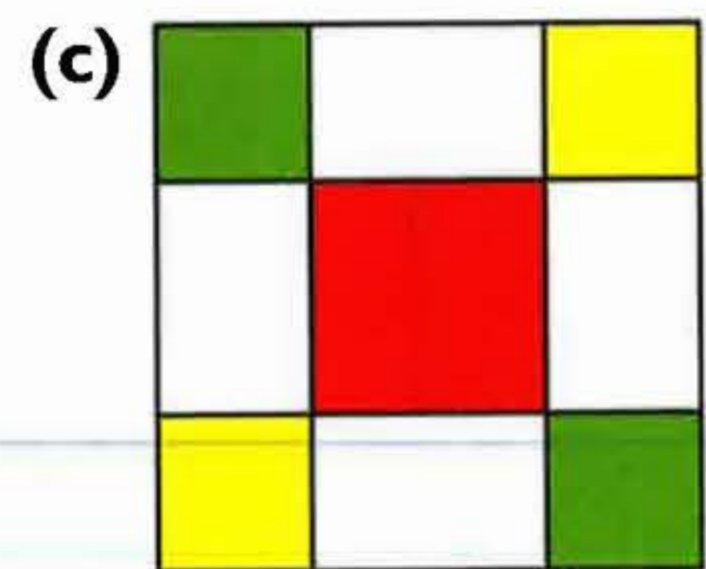
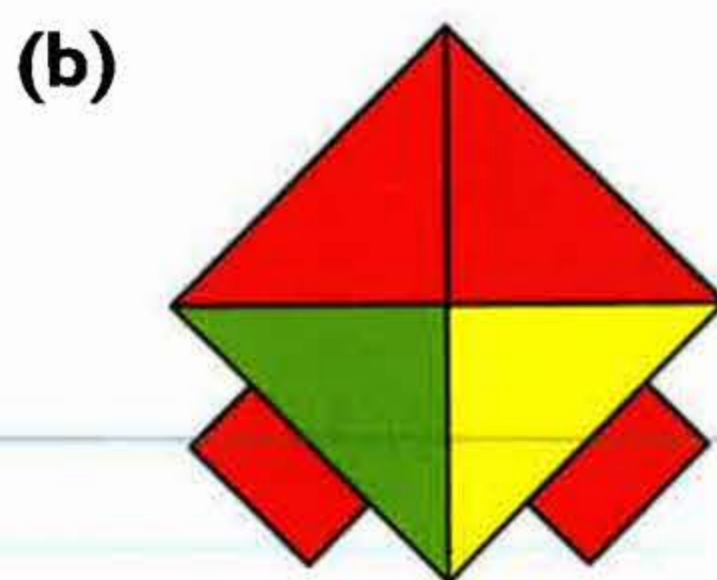
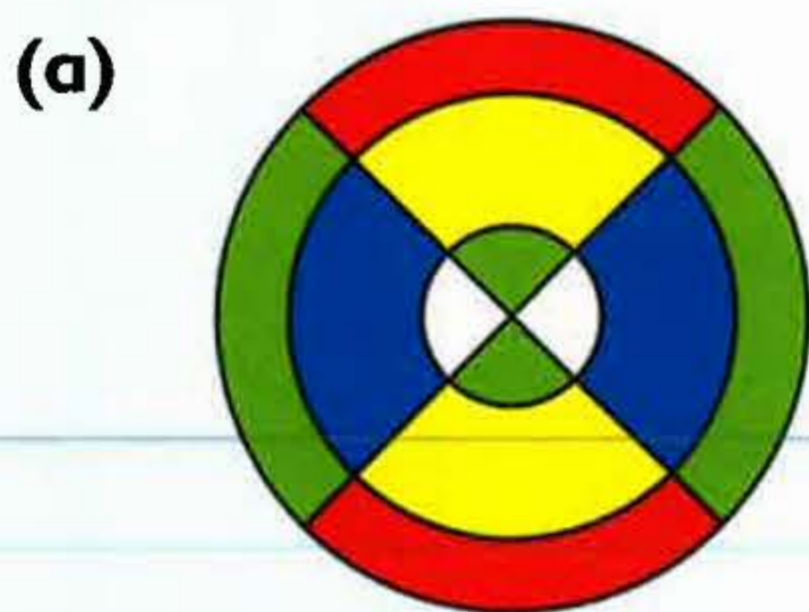



## 2 Cleachd pàipear ceàrnagach.



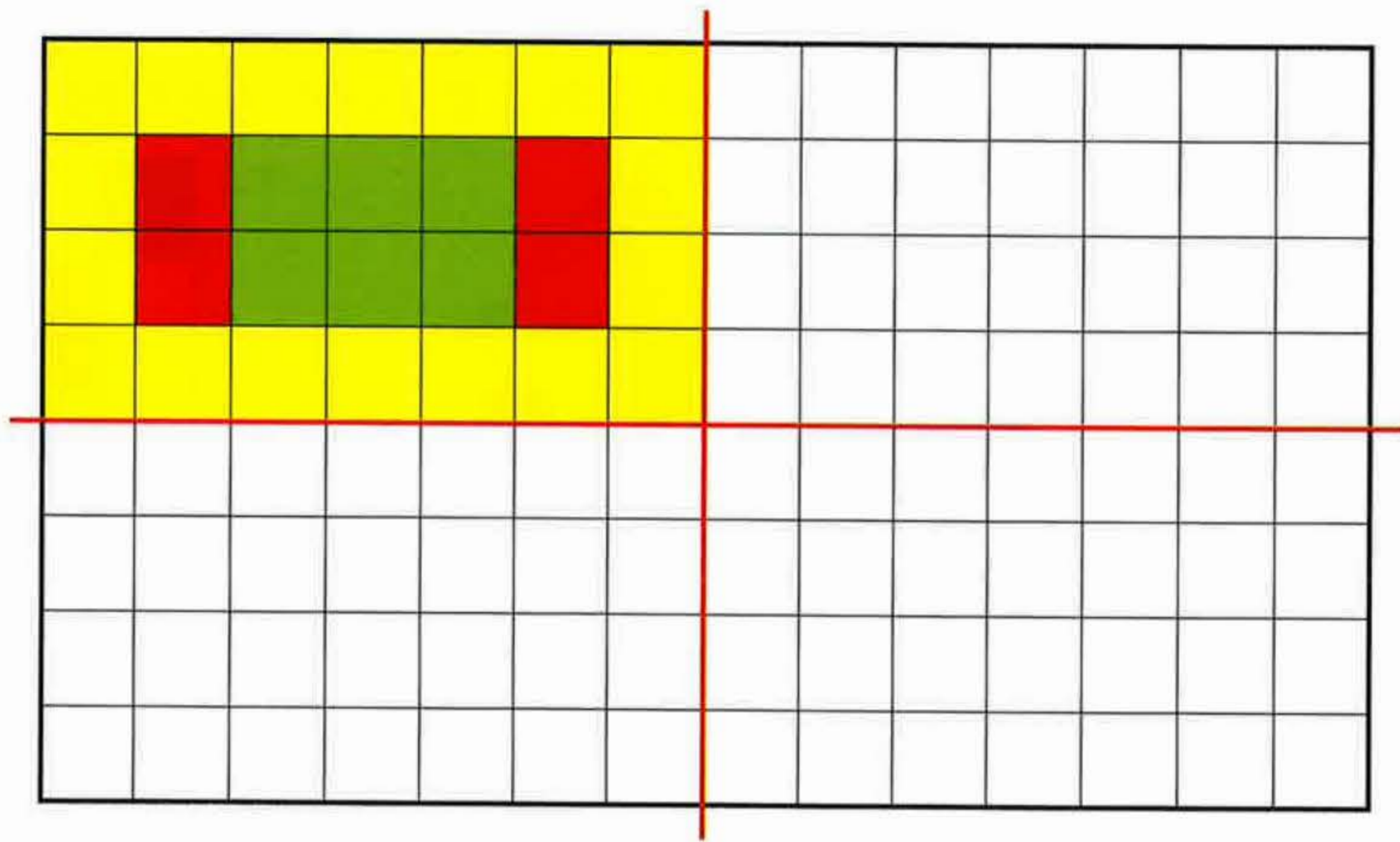
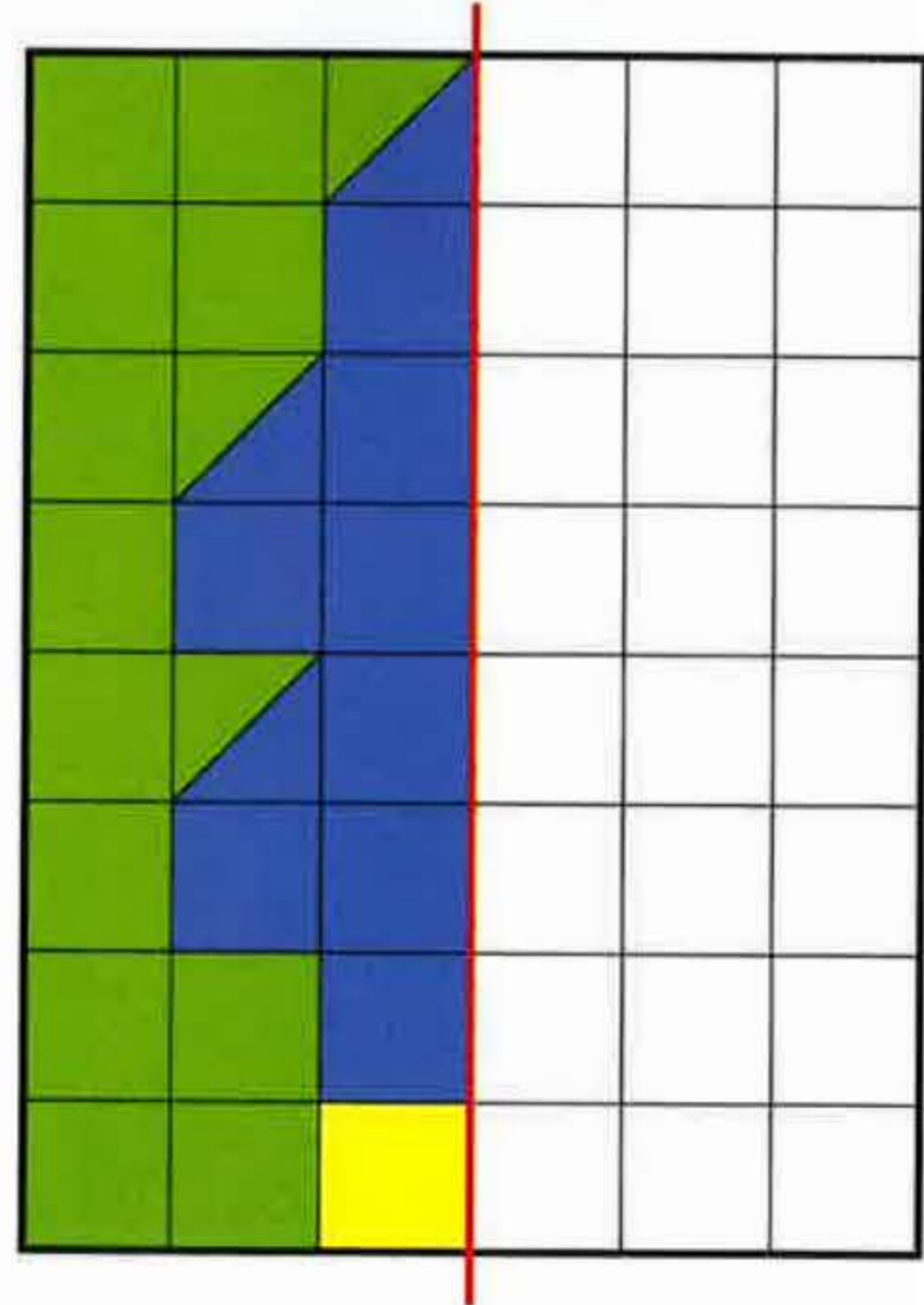
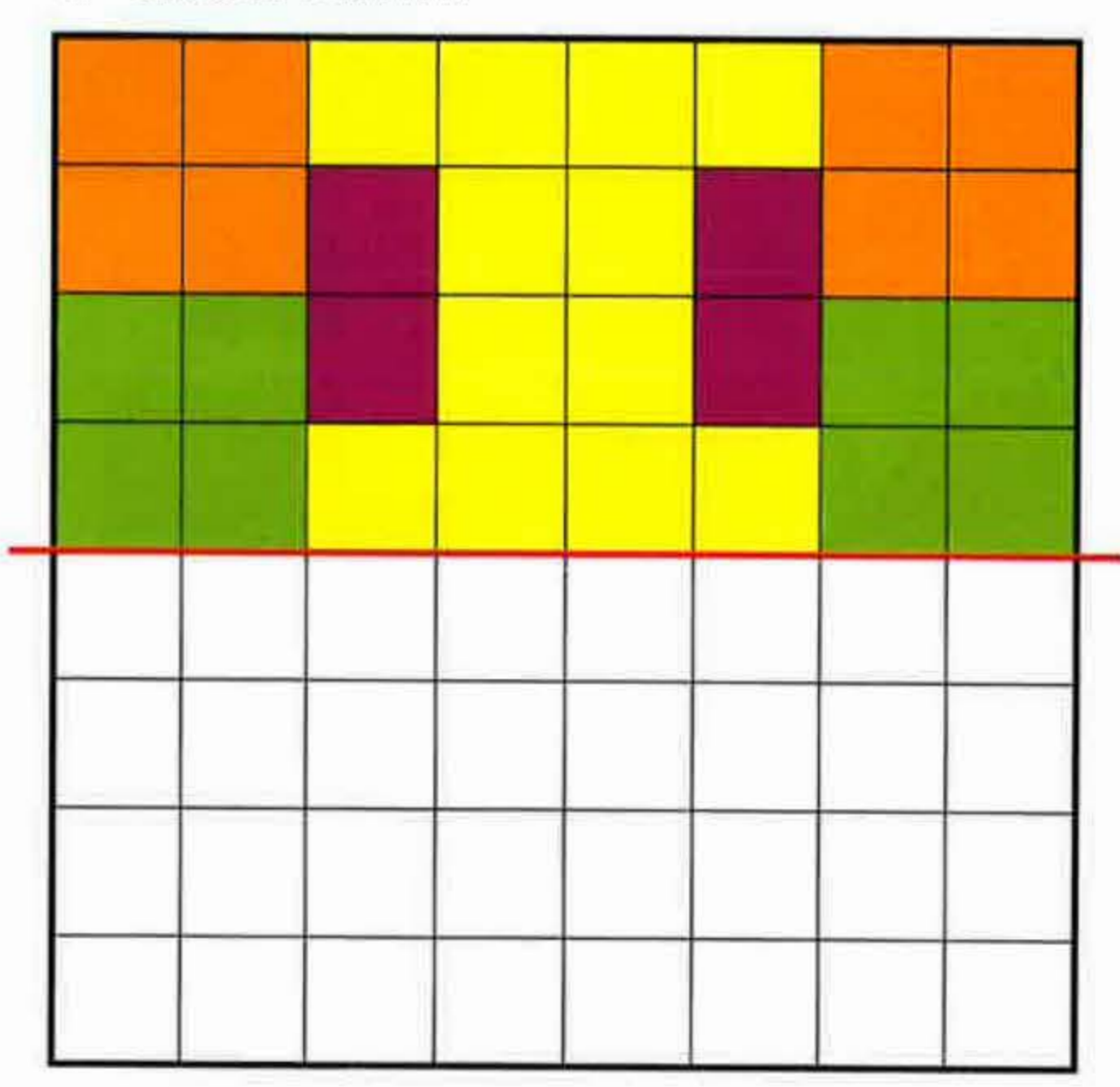





1 Ath-dhealbh agus dath iad seo, gus pàtranan co-chothromach a dhèanamh.

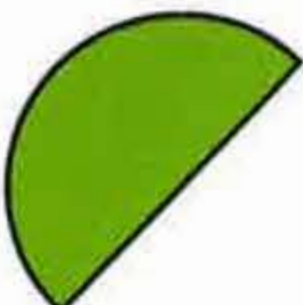
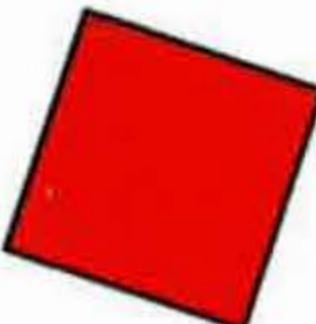
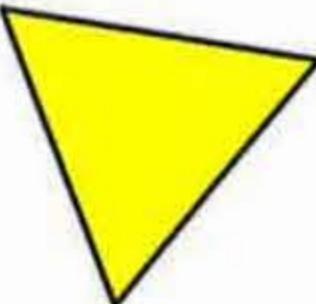

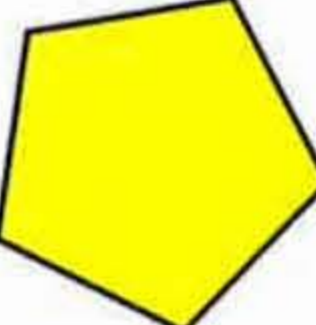
2 Dèan **pàirt** de phàtran cho-chothromach airson caraid a chrìochnachadh.

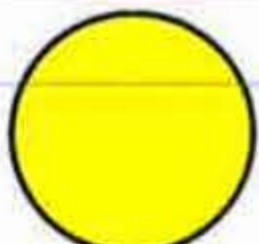
Cuir a-steach loidhne a' cho-chothromachaidh.

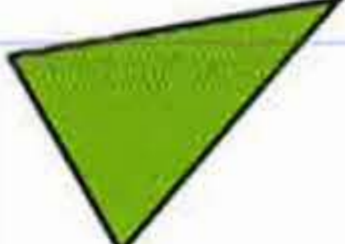

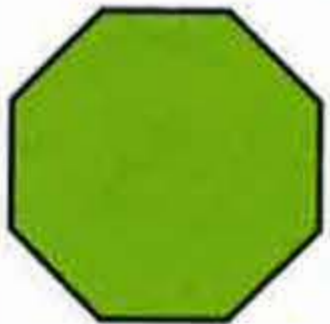
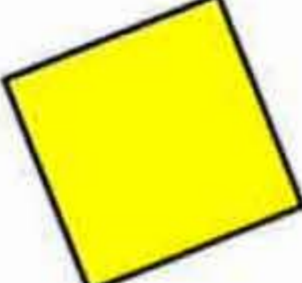
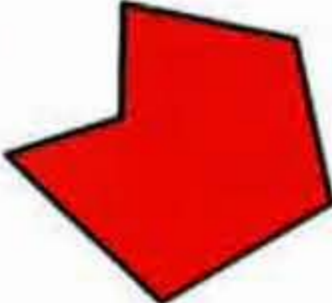
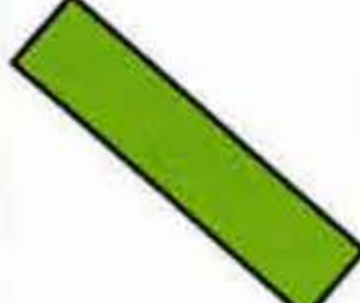
5						
4						
3						
2						
1						
	1	2	3	4	5	6

Tha **a'** cheàrnag dhearg ann am bogsa 3, 5  
Tha **an triantan uaine** ann am bogsa 5, 3.

1 Dè am bogsa anns a bheil:

- (a) triantan gorm (b) ceàrnag bhuidhe (c) sia-cheàrnach gorm  
(d) còig-cheàrnach dearg (e) sia-cheàrnach dearg  
(f) ochd-cheàrnach uaine?

2 Dè a tha anns a' bhogsa:

- (a) 2,2 (b) 3,4 (c) 1,5 (d) 5,4 (e) 4,5 ?



41 Tha co-chomharran  $(0, 2)$  aig an spot dhearg. Sgrìobh co-chomharran nan spotan seo:

- (a) orains
- (b) geal
- (c) gorm
- (d) dubh
- (e) buidhe
- (f) uaine
- (g) purpaidh
- (h) donn.

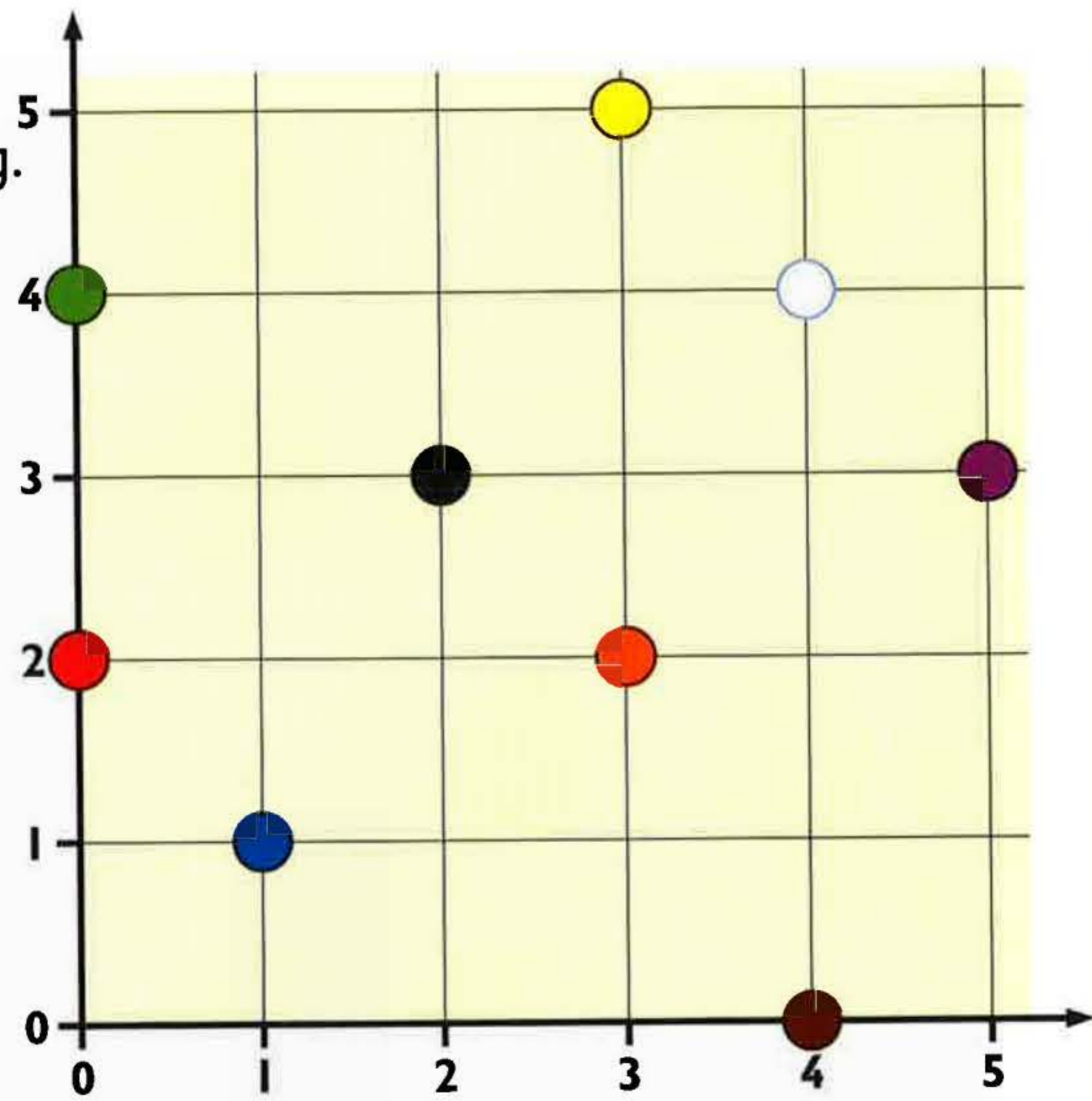

2 Dè an dath a tha air an spot aig gach fear de na suidheachaidhean seo?

- (a)  $(1, 2)$       (b)  $(6, 1)$       (c)  $(2, 1)$       (d)  $(5, 0)$       (e)  $(8, 2)$
- (f)  $(7, 0)$       (g)  $(3, 3)$       (h)  $(2, 2)$       (i)  $(0, 3)$

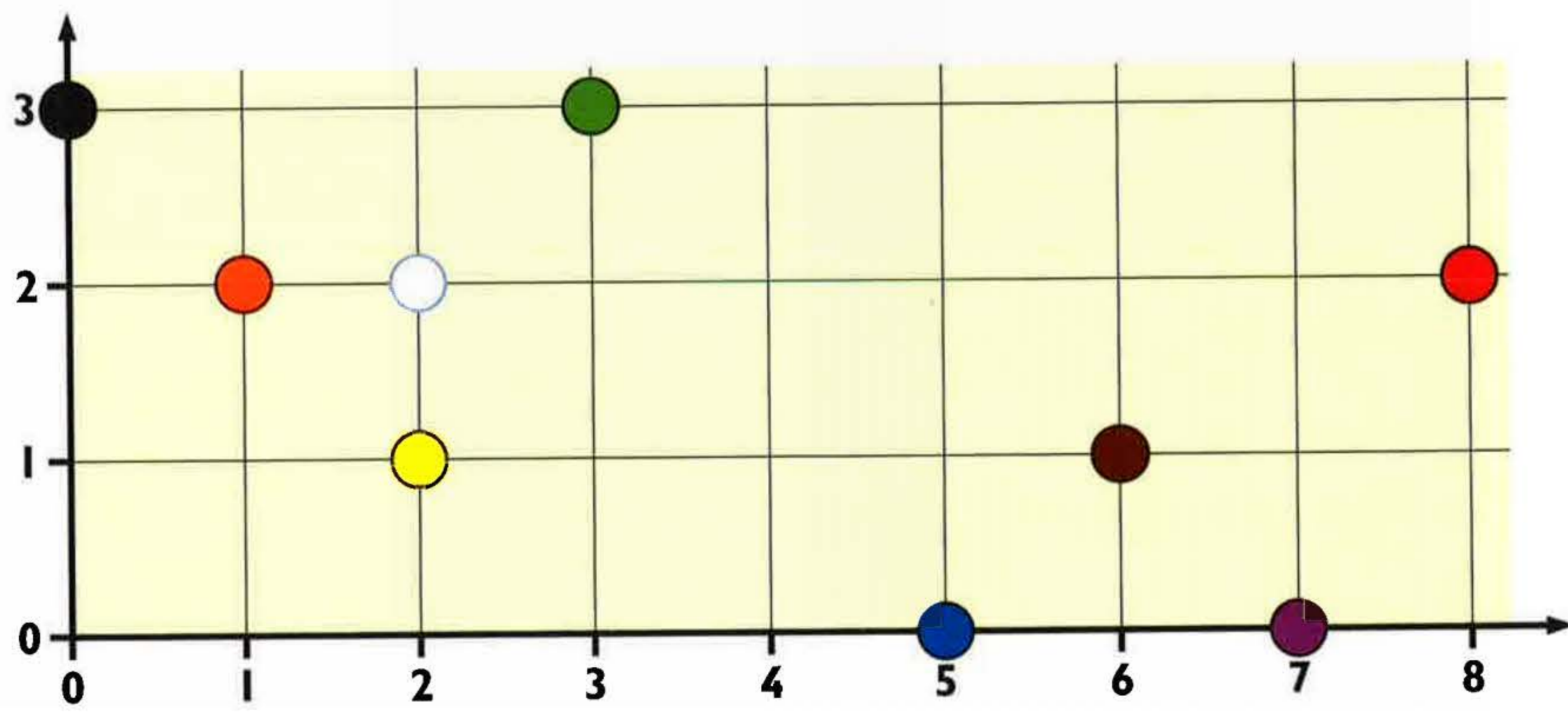



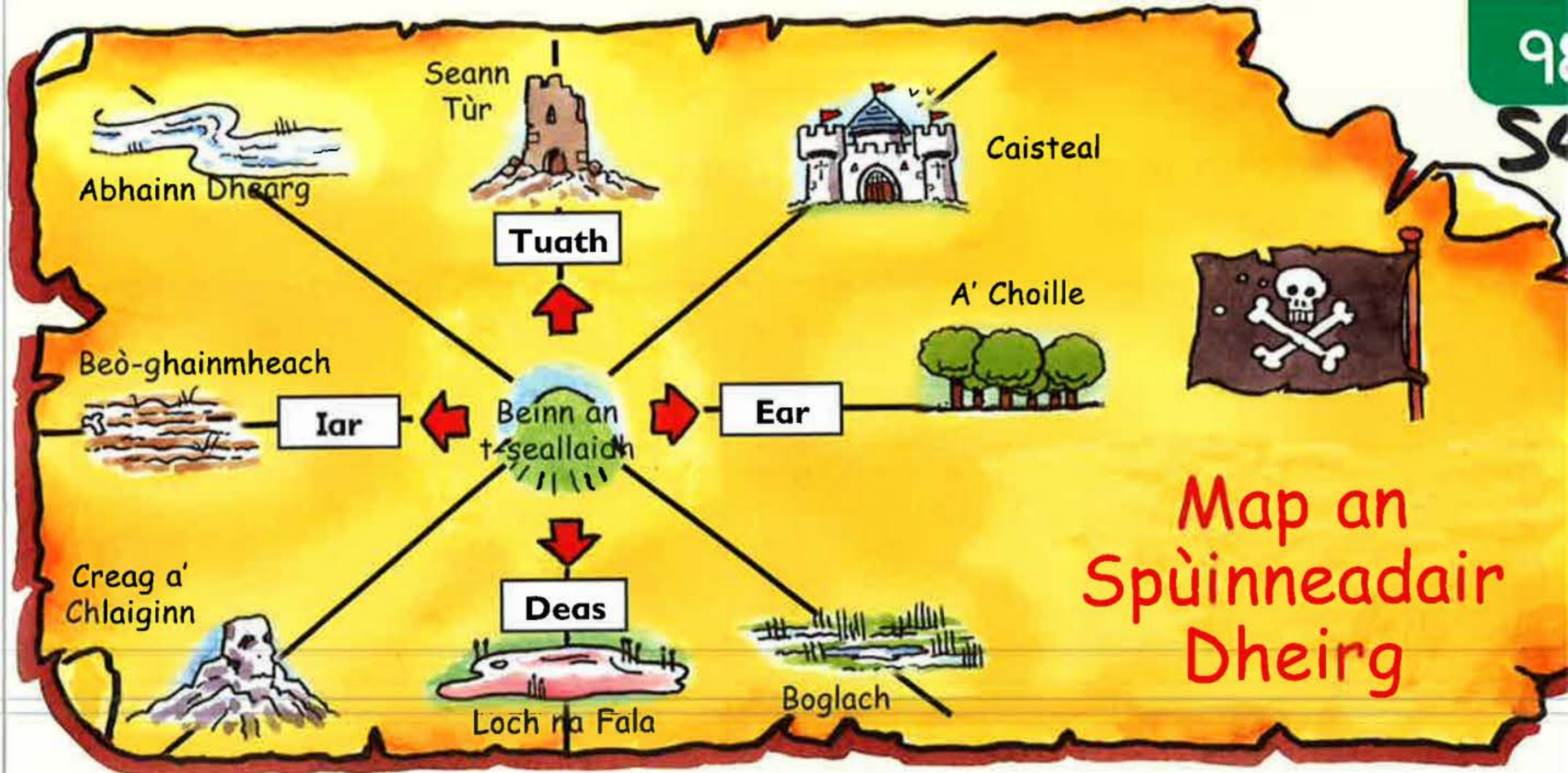

**Tha thu air mullach Beinn an t-Seallaidh.**

1 Dè a chì thu nuair sheallas tu:

(a) gu Tuath (b) gu Deas (c) chun Ear (d) chun Iar?

2 Dè an àird aig a bheil:

(a) Loch na Fala (b) A' Choille (c) Beo-ghainmheach  
(d) An Seann Tùr?

3 **Seall chun Ear.**

Dè a chì thu nuair thionndaidheas tu tro:

(a) leth-chuairt (b) cheàrn cheart tuathal (c) chuairt iomlan?

4 **Seall gu Deas.**

Dè an àird gu bheil thu a' sealltainn nuair thionndaidheas tu tro:

(a) chairteal chuairt deiseil (b) 3 ceàrnan ceart deiseil?

5 Sgrìobh fiosrachadh nan tionndaidhean seo.

(a) Seall gu Loch na Fala. Tionndaidh chun na Coille.

(b) Seall chun na h-Aibhne Deirge. Tionndaidh chun a' Bhoglaich



(c) Seall ri Creag a' Chlaiginn. Tionndaidh chun na h-Aibhne Deirge



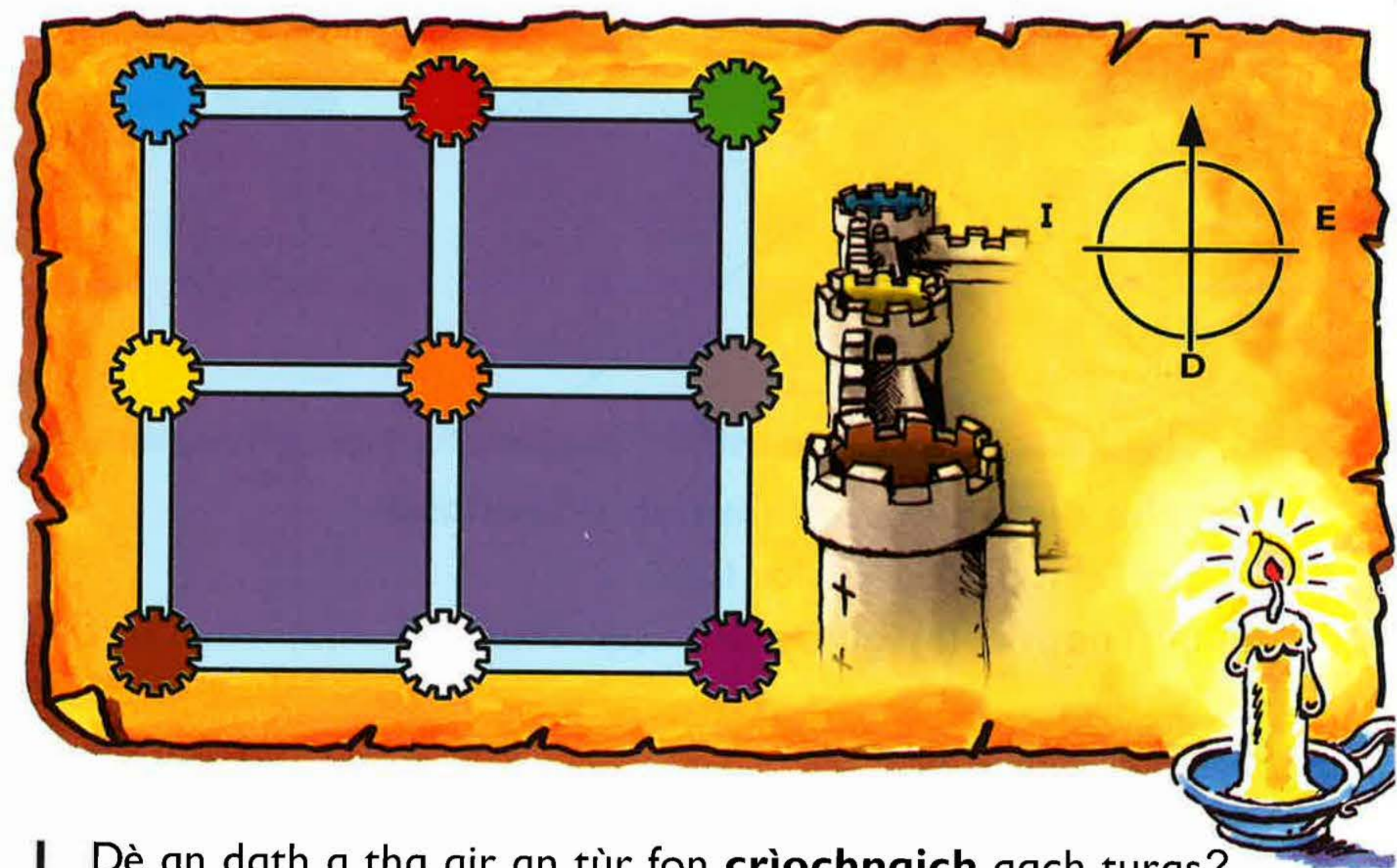











Tha tùraichean a' chaisteil aig an Spùinneadair Dhearg air an ceangal le tunailean.



1 Dè an dath a tha air an tùr fon **crìochnaich** gach turas?

- (a) Tòisich aig  . Theirig Tuath tro 1 thunail, an Ear tro 2 thunail agus gu Deas tro 1 thunail.
- (b) Tòisich aig  . Theirig Deas tro 1 thunail, chun Iar tro 2 thunail, Deas tro 1 thunail agus chun Ear tro 1 thunail.

2 Mìnich turas a tha a' dol:

- (a) bho  gu  nach eil a' dol tro 
- (b) bho  gu  nach eil a' dol tro  no 
- (c) bho  gu  a tha a' dol tro  ,  agus  .

3 Sgrìobh mu dhà thuras eadar-dhealaichte bho  gu  .



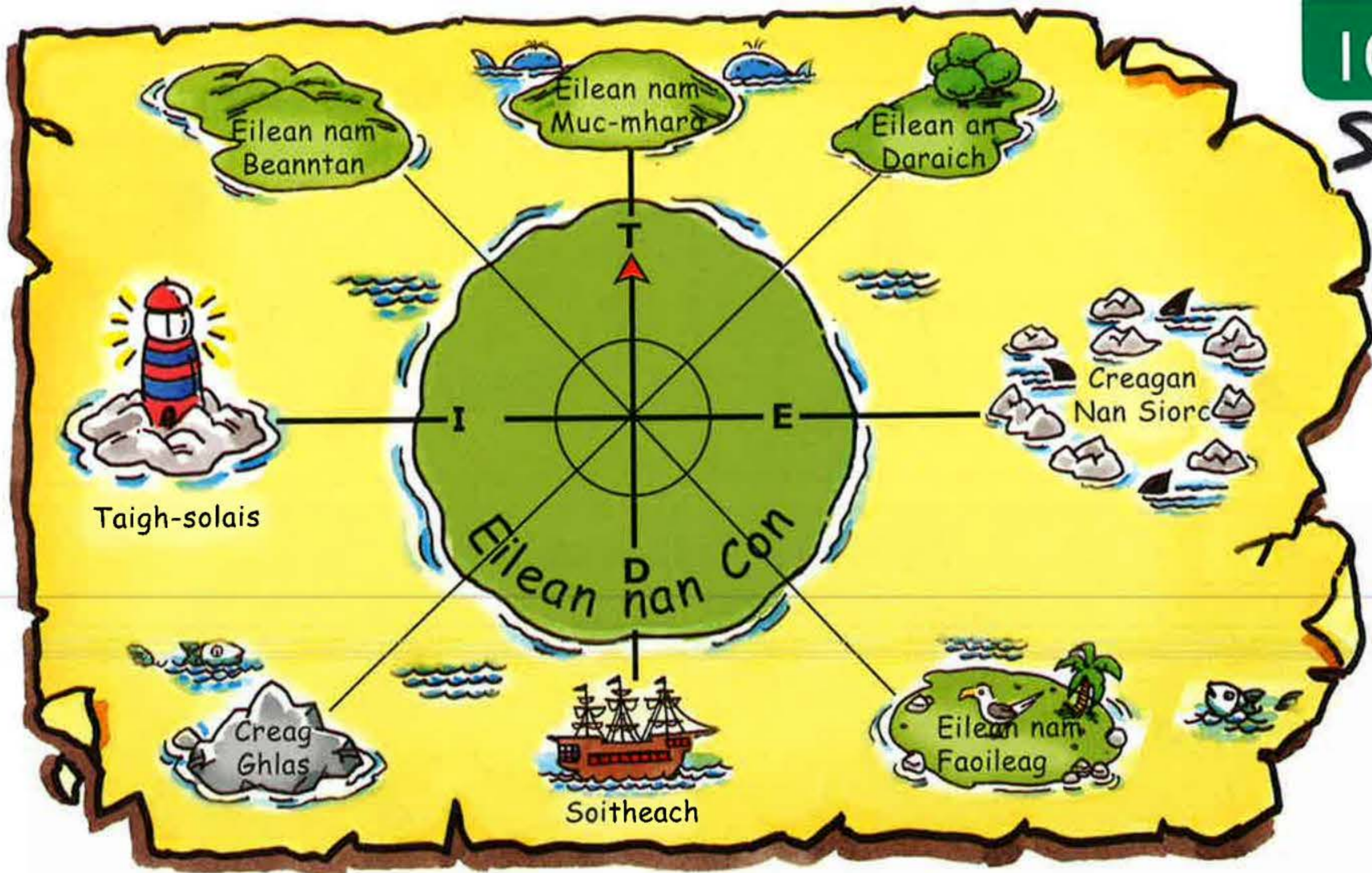

Tha thu ann am meadhan **Eilean nan Con**.

### 1 Seall gu Tuath.

Dè an àird gu bheil thu a' sealltainn an dèidh dhut car mar seo a chur:

- (a)  $90^\circ$  gu tuathal                      (b)  $180^\circ$  gu deiseil  
(c)  $360^\circ$  gu tuathal                      (d)  $45^\circ$  gu deiseil?

### 2 Seall chun Iar.

Cò ris a tha thu a' coimhead an dèidh dhut car mar seo a chur:

- (a)  $90^\circ$  gu deiseil                              (b)  $180^\circ$  gu tuathal  
(c)  $270^\circ$  gu tuathal                              (d)  $45^\circ$  gu deiseil?

### 3 Mìnich gach car.

- (a) Seall gu Creagan nan Siorc. Tionndaidh gu Eilean nam Muc-mhara.  
(b) Seall gu Creag Ghlas.  
Tionndaidh chun an taigh-sholais.  
(c) Seall gu Eilean nam Beanntan.  
Tionndaidh gu Eilean nam Faoileag.  
(d) Seall gu Eilean an Daraich.  
Tionndaidh gu Eilean nam Muc-mhara.





### Sgrìobh an ceàrn as motha.

4

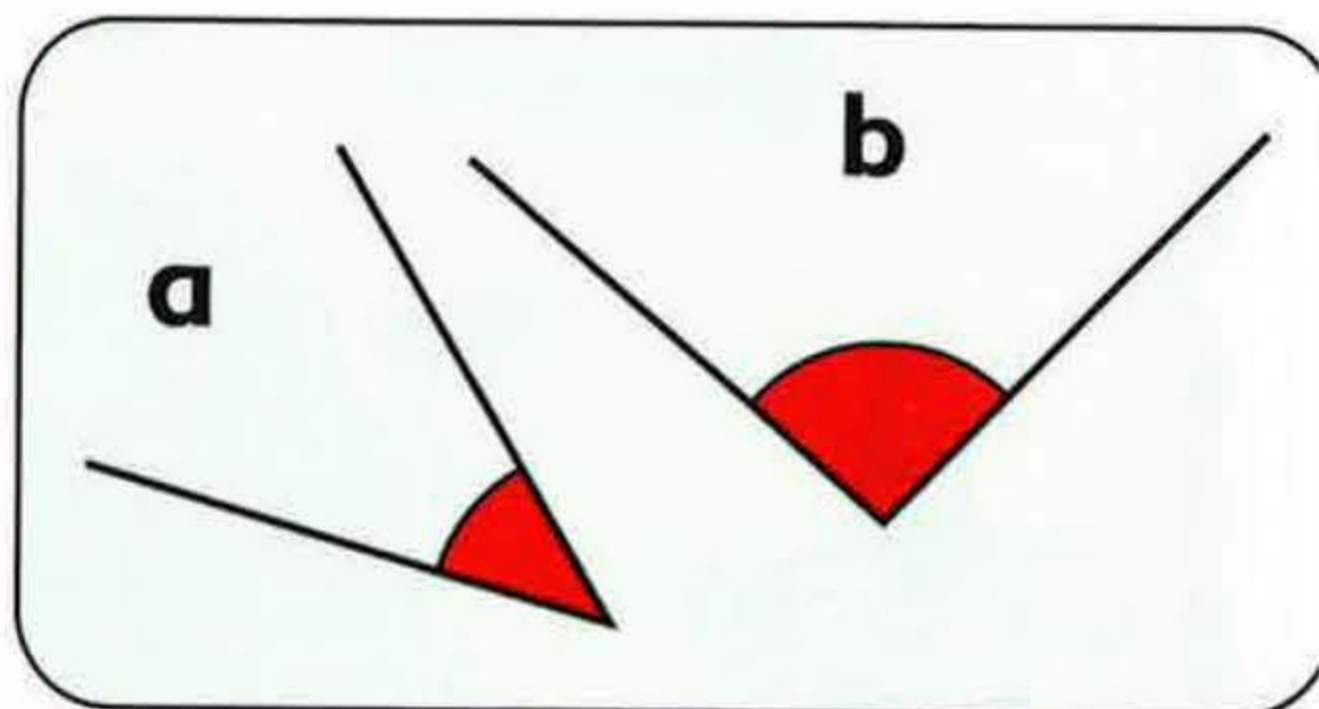
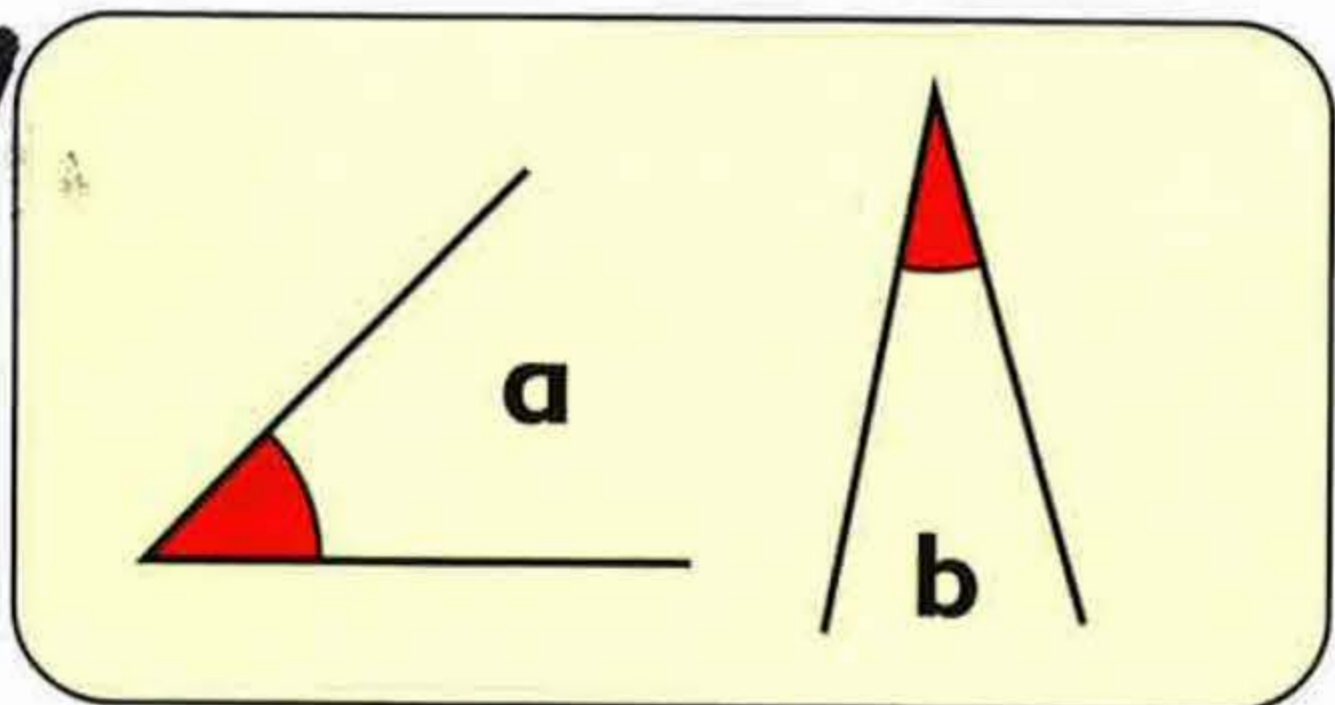

2

### Sgrìobh an ceàrn as lugha.

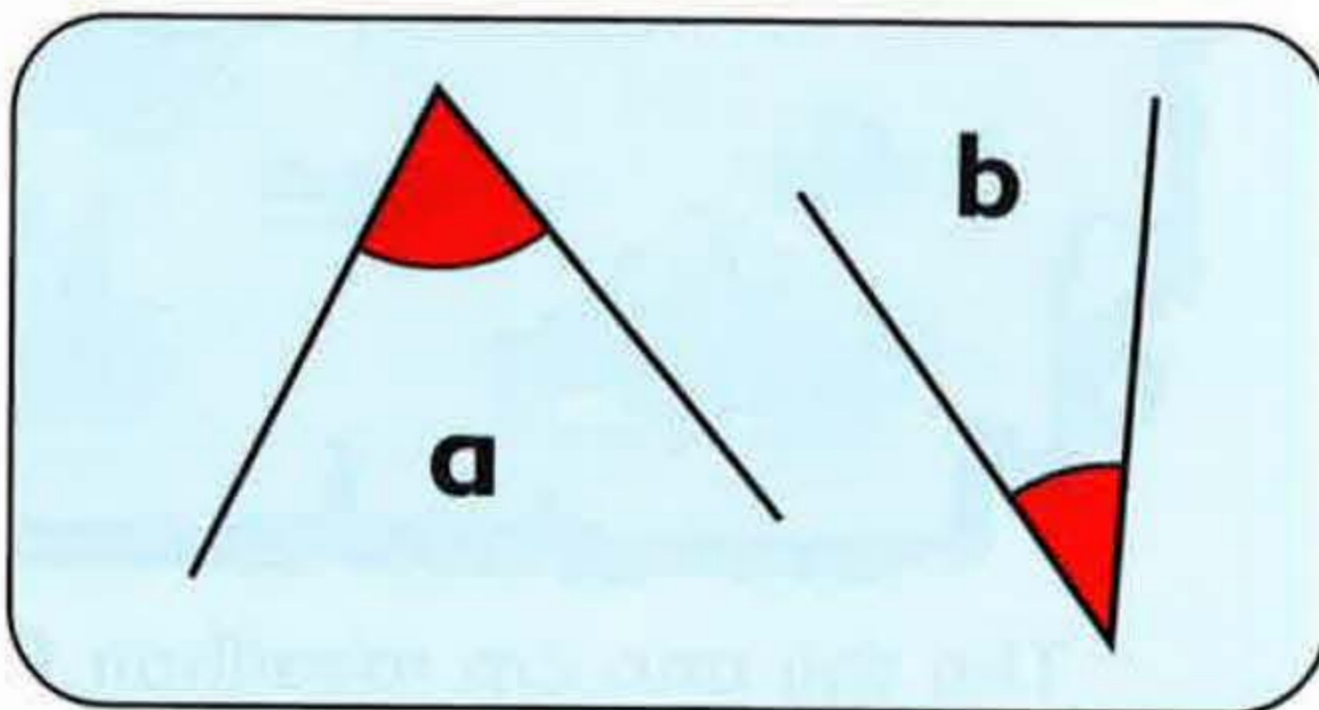
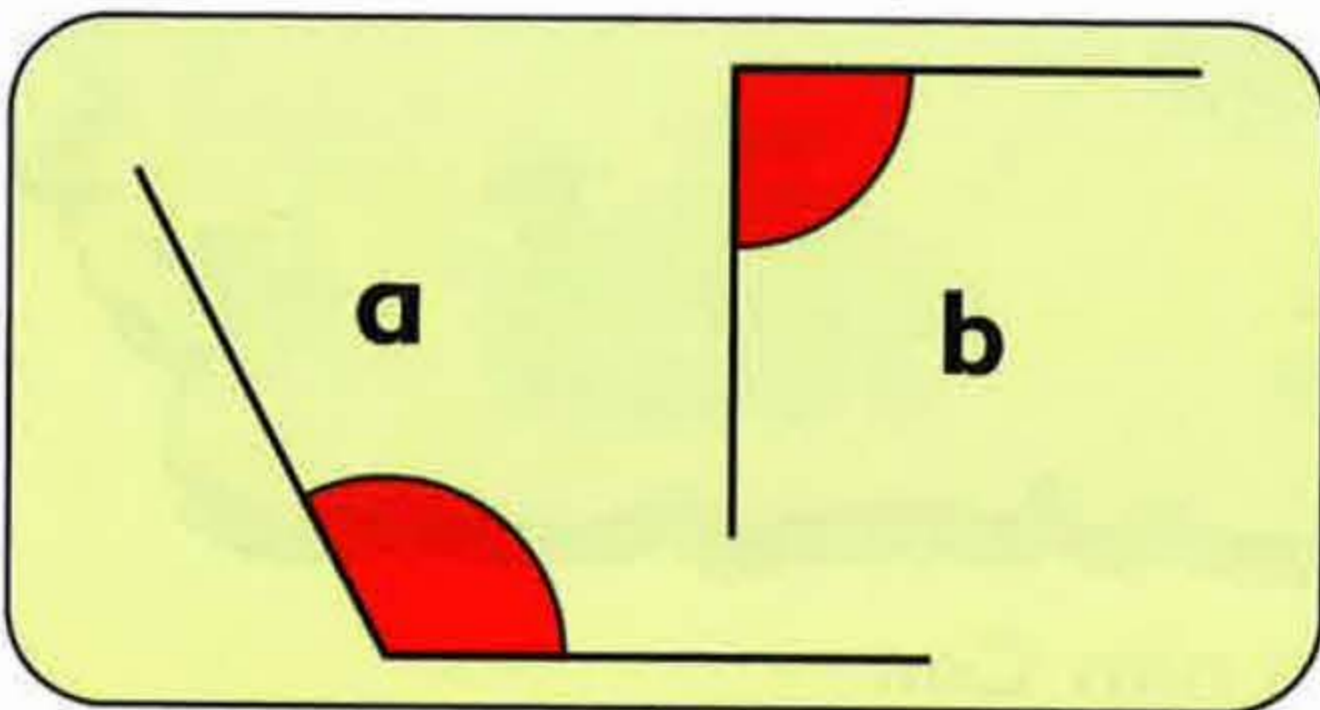

3 Cuir na ceàrnannan ann an òrdugh, a' tòiseachadh leis an fhear as lugha.

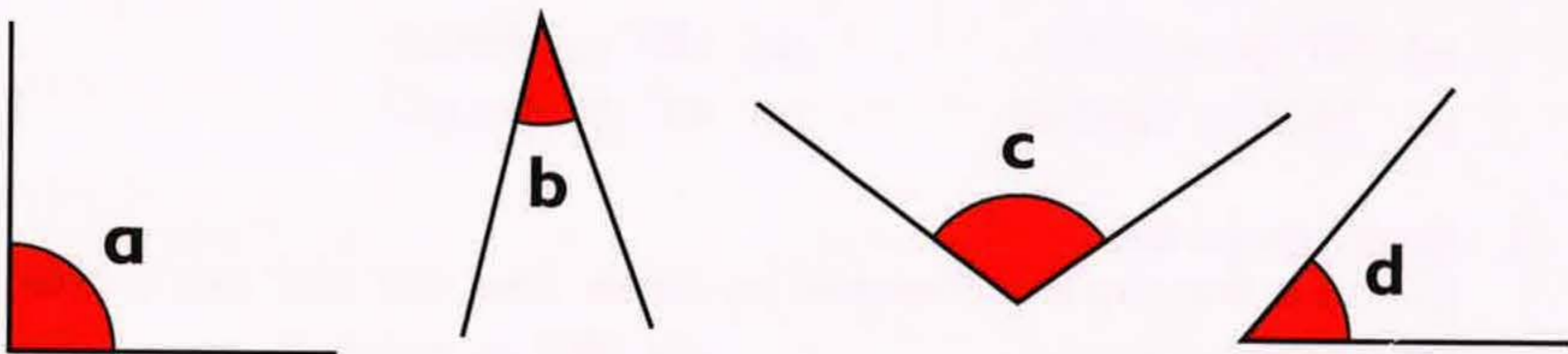

4 Cuir na ceàrnannan ann an òrdugh, a' tòiseachadh leis an fhear as motha.

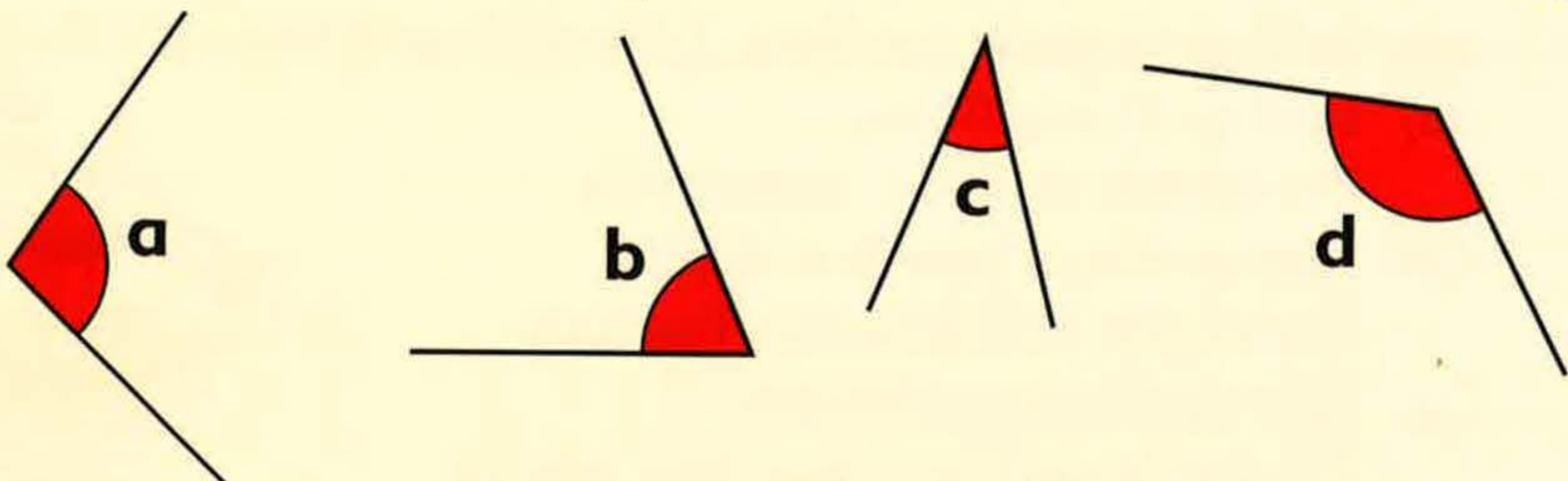



# PÀIRC NAN CLAMHAN

FOSGAILTE: An Giblean chun an t-Sultain  
9.00 m. - 6.00 f.  
COSG: Inbhich £5 Leanabh £3.50

Tachartasan sònraichte	Ceann-latha	Suidheachadh
Go-cairtean	Dis 29mh Iuchar	Trac nan Rèis
Biastagan	Dis 5mh Lùnastal	An Teanta Uaine
Rèisean	Dis 12mh Lùnastal	Trac nan Rèis
Cuairt nan Craobhan	Dis 19mh Lùnastal	Seann Tùr
Latha an Lorgaidh	Dis 26mh Lùnastal	Teanta Saidheans
Bumpairean	Dis 2mh Sultain	Trac nan Rèis

- 1 Cia mheud mìos anns a' bhliadhna a tha a' phàirc fosgailte?
- 2 Cia mheud uair a thìde a tha i fosgailte gach latha?
- 3 Dè na tachartasan a tha a' gabhail àite aig Trac nan Rèis?
- 4 Dè an tachartas a ghabhas àite air: a) 5mh Lùnastal b) 26mh Lùnastal?
- 5 Dè na chosgais latha ann am Pàirc nan Clamhan airson 2 inbheach agus 4 chloinne?
- 6 Dè na tachartasan a tha thu a' smaoinneachadh a tha a' gabhail àite am broinn togalach?

A' TÒISEACHADH	Àireamh de luchd-tadhail			
	9.00 m.	10.30 m.	12.00 m.l.	1.30 f.
Cuairt tron Choille	12	18	9	19
Ràth na h-Aibhne	13	27	11	29
Am Balla	15	17	13	20
Boghadaireachd	6	19	15	15





- 7 Dè an tachartas aig an robh an àireamh bu mhotha de dhaoine rè an latha gu lèir?
- 8 Cia mheud neach-tadhail a bha aig seasain 1.30 f. gu lèir?
- 9 Lorg an tachartas agus an uair aig an do thòisich e, aig an robh: (a) an àireamh bu mhotha (b) an àireamh bu lugha de luchd-tadhail.
- 10 An robh barrachd dhaoine aig na cur-seachadan anns a' mhadainn, no feasgar? Mìnich.



CH1

### Blastagan aig Pàirc nan Clamhan

### Suim

1 Cia mhead de gach seòrsa biastaig a chaidh fhaicinn?

- (a)  (b)  (c)  (d)  (e) 

2 Cia mhead biastag a chaidh fhaicinn gu lèir?

3 Cia mhead biastag air a bheil: (a) spotan (b) srianagan?

4 Cia mhead a bha ann den chiad seòrsa a bharrachd air na bha ann den dàrna seòrsa?

- (a)  na  (b)  na  ?

### Nuair chaidh blastagan fhaicinn

### Suim

m. – 10.15 m.		
11.30 m. – 11.45 m.		
f. – 1.30 f.		
f. – 3.00 f.		

5 Cia mhead biastag a chaidh fhaicinn eadar:

- (a) 10.00 m. – 10.15 m (b) 11.30 m. – 11.45 m  
(c) 1.15 f. – 1.30 f (d) 2.45 f. – 3.00 f.?

6 An e a' mhadainn no am feasgar a b' fheàrr airson blastagan fhaicinn? Mìnich.



## Cunntas làithean-saora Clas 4

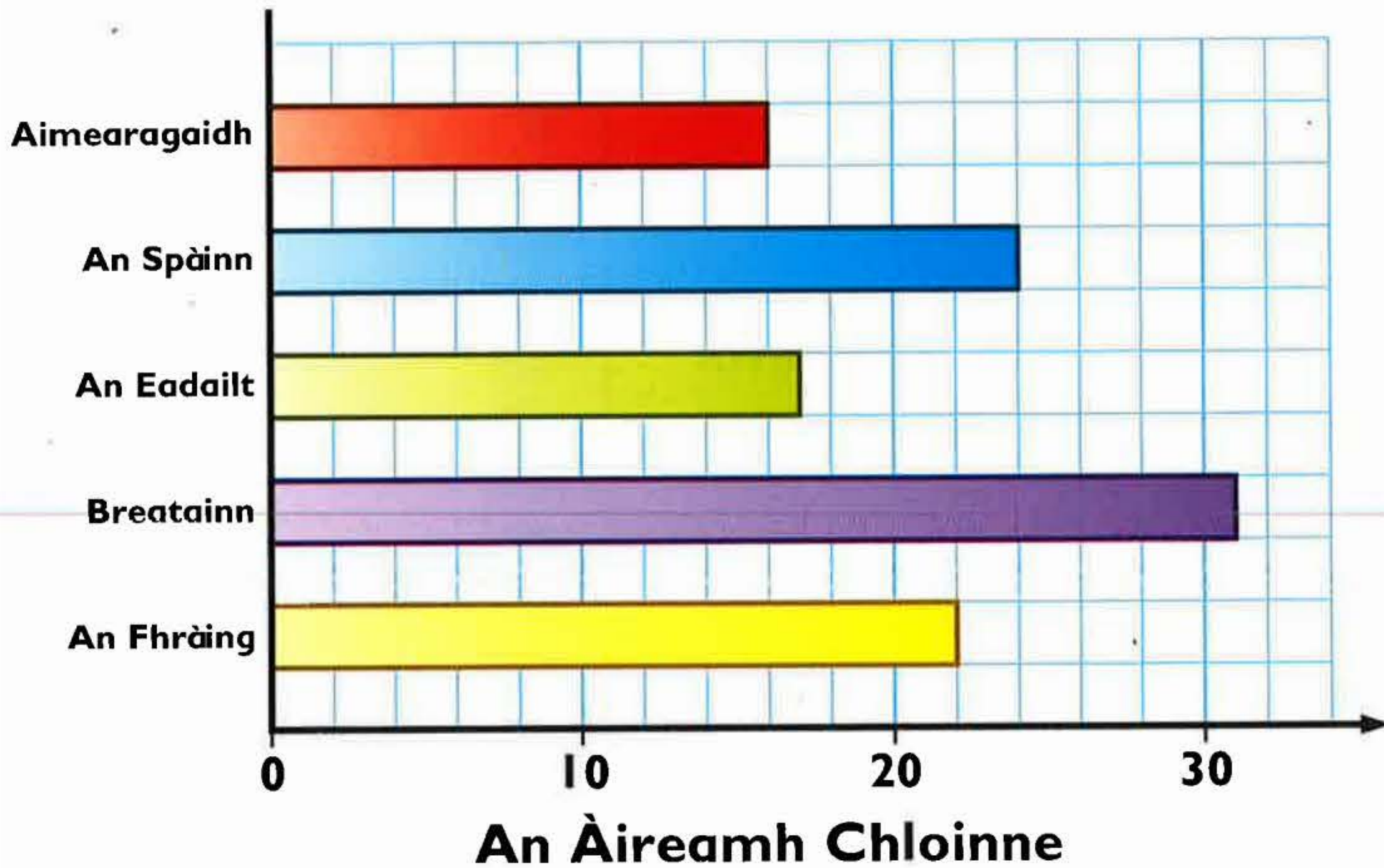

- Dè an dùthaich gun deach:
  - an àireamh bu mhotha de chloinn
  - an àireamh bu lugha de chloinn?
- Dè an dùthaich a tha anns an treas àite?
- Cia mheud leanabh a bha:
  - thall thairis
  - ann an dùthaich Eòrpach eile?
- Cia mheud leanabh a bharrachd aig an robh làithean-saora:
  - ann am Breatainn na anns an Fhràing
  - anns an Spàinn na ann an Aimearagaidh?
- Cia mheud leanabh ann an Clas 4 aig an robh làithean-saora gu lèir?
- Dè an dà dhùthaich còmhla anns an robh trichead leanabh 's a trì airson nan làithean-saora?



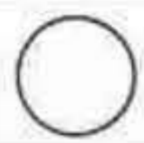

### Peataichean Clas 4

 = 2 pheata

Dè am peata:

- (a) as cumanta
- (b) as neo-chumanta?

2 Cia mheud a bharrachd

- (a) coin na cait
- (b) èisg na eòin

3 Cia mheud peata a tha aig clann Clas 4 gu lèir?

4 Cia mheud peata aig a bheil barrachd air 2 chois?

### Àireamh pheataichean

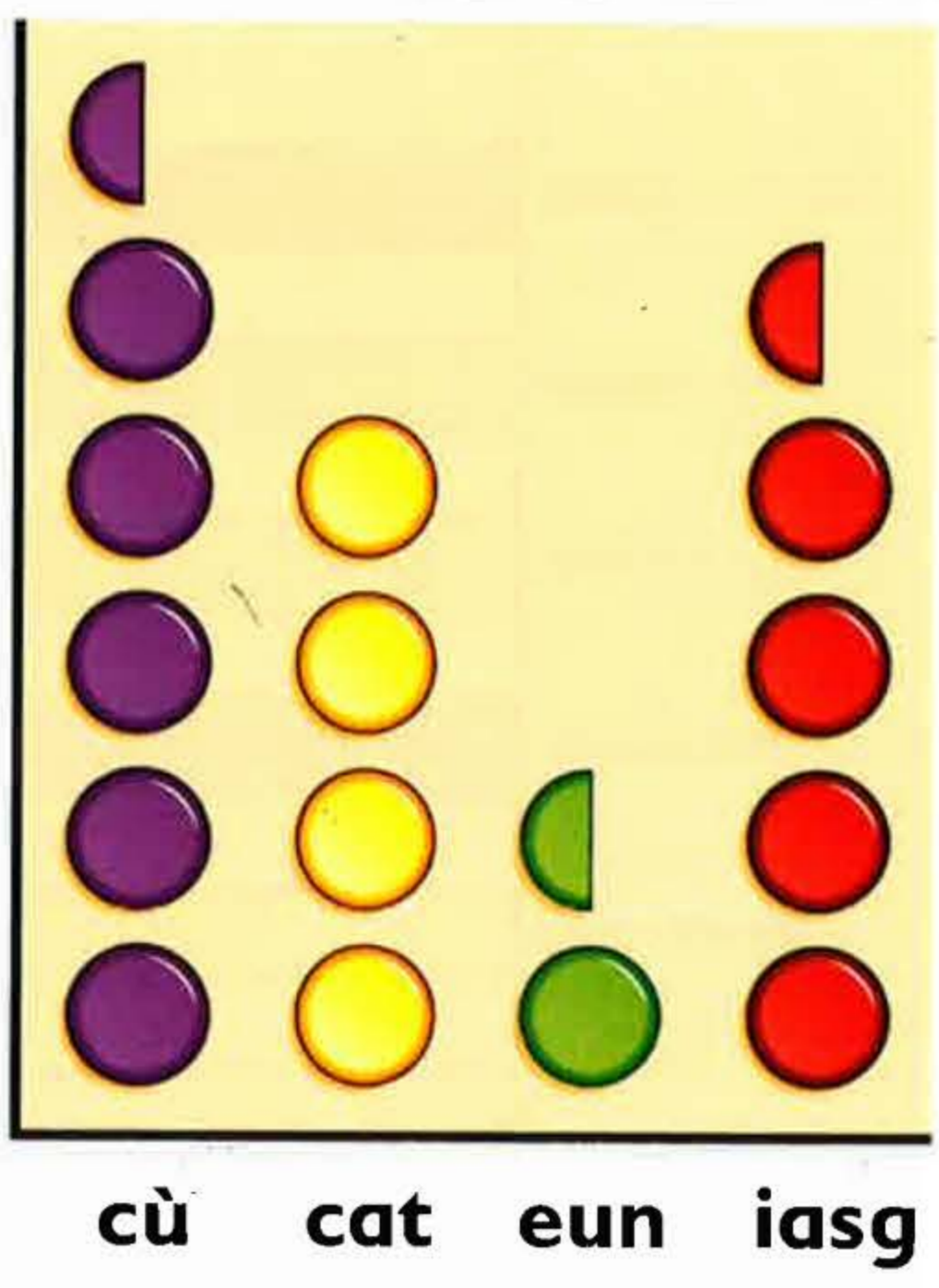

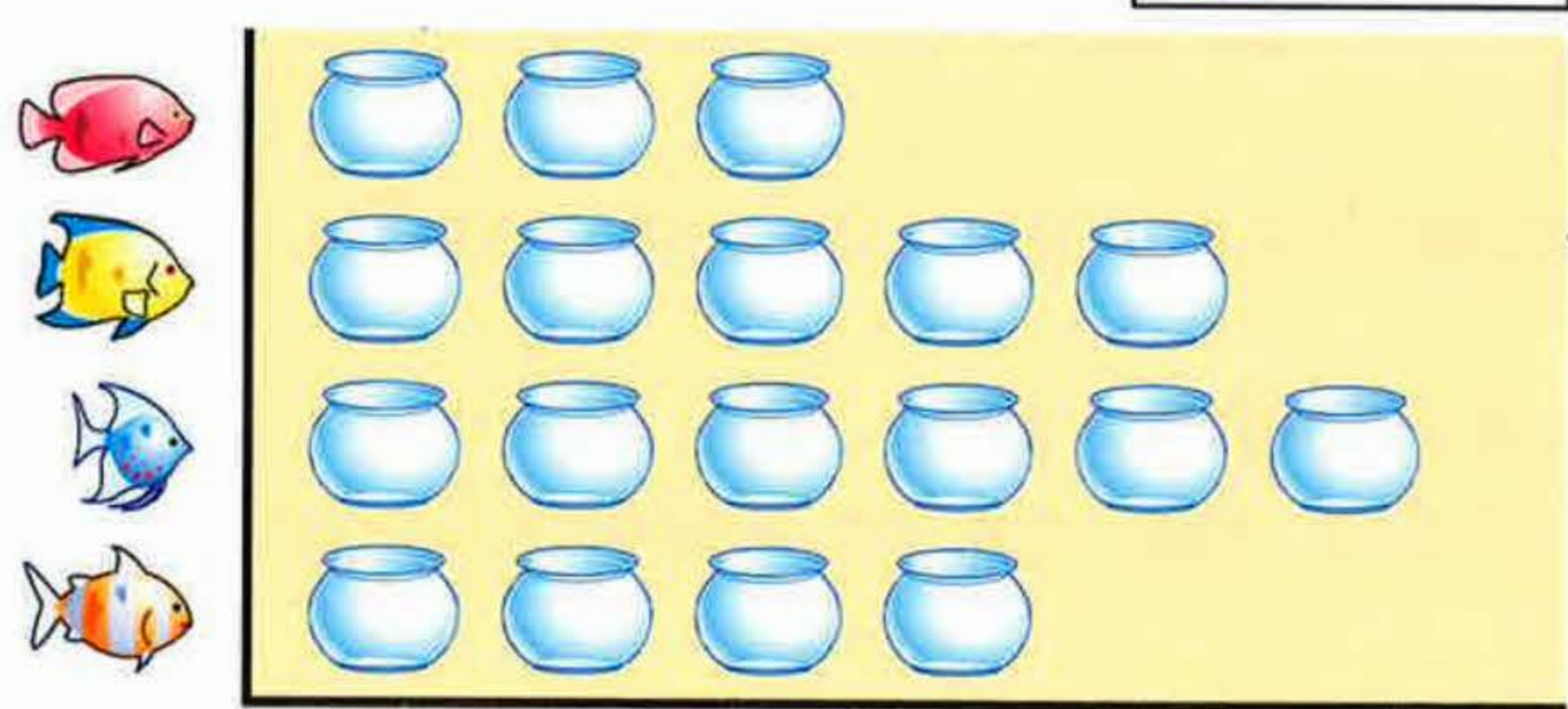

### Tanca-èisg thropaigeach

 = 5 èisg



### Àireamh èisg

5 Cia mheud a tha ann de: (a)  (b)  (c)  (d)  ?

6 Cia mheud iasg a tha anns an tanca gu lèir?

7 Cia mheud a bharrachd a tha ann de:

- (a)  na  (b)  na  (c)  na  ?





I (a) Sgrìobh na litrichean ann an diagram mar seo.

Tha loidhne cothromachaidh innte	<del>Tha loidhne cothromachaidh innte</del>

(b) Tagh ceithir litrichean eile. Cuir iad seo dhan diagram agad.

(a) Sgrìobh ainmean a' bhannail ann an diagram mar seo.

	glainneachan	<del>glainneachan</del>
feusag		
<del>feusag</del>		

(b) Dèan an t-aon rud airson an diagram seo.

	ad	gun ad
fireann		
boireann		

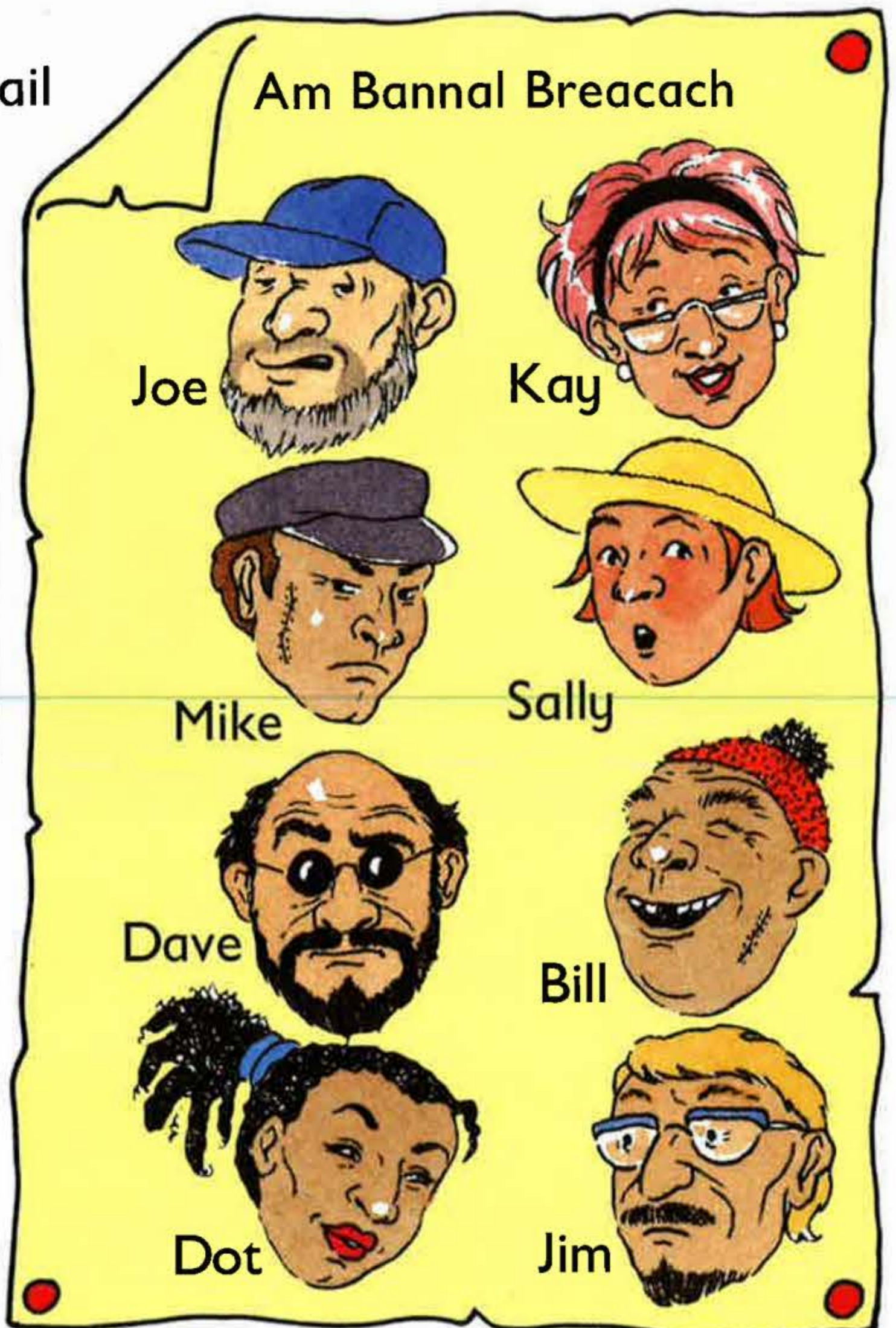



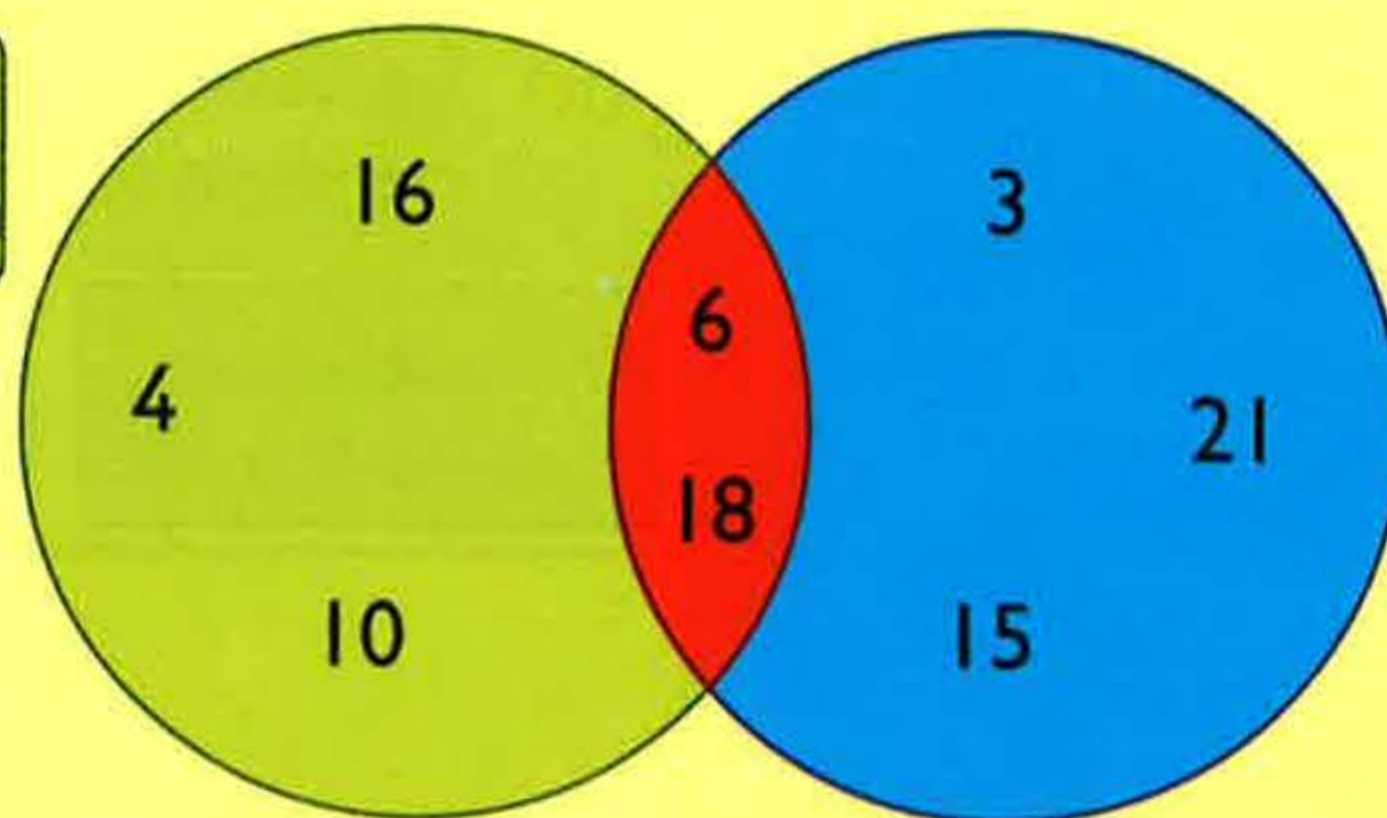

IHS

Àireamhan  
cothromachIomadan  
de 3

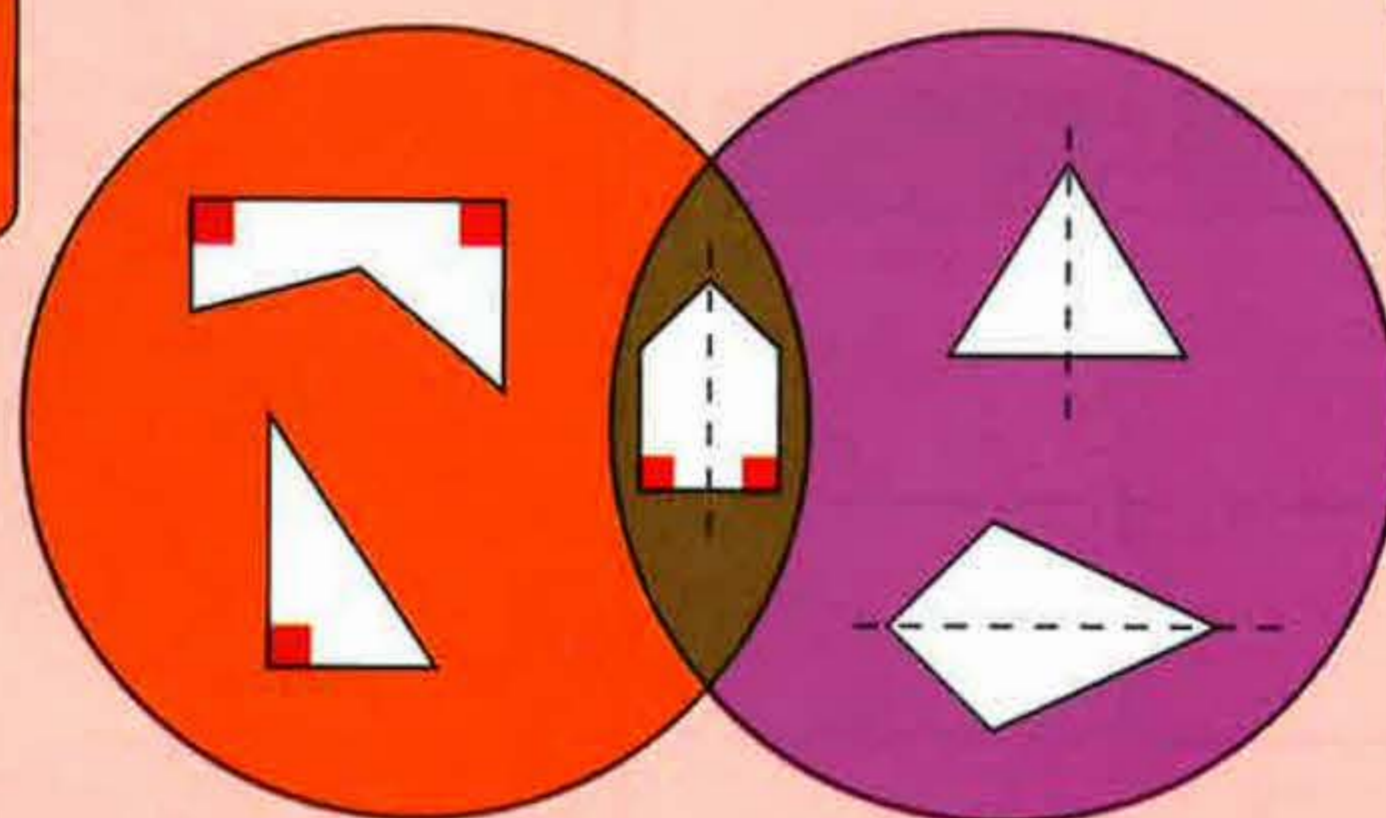
- Sgrìobh trì àireamhan eile a dh'fhaodadh a dhol dhan:  
(a) phàirt uaine      (b) phàirt ghorm      (c) phàirt dhearg.
- Càit, anns an diagram Venn, an cuireadh tu na h-àireamhan seo?  
(a) 8      (b) 30      (c) 27      (d) 19

Le co-dhiù aon  
cheàrn ceartLe loidhne  
cothromach

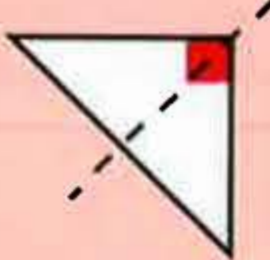
- Dè am pàirt den diagram Venn anns an cuireadh tu na cruthan seo  
(a)       (b) 
- Cleachd pàipear ceàrnagach. Dealbh cruth a dh'fhaodadh a dhol dhan:  
(a) phàirt orains      (b) phàirt phurpaidh      (c) phàirt dhonn.